

GMV5 DC INVERTER VRF UNITS

(GC201903-IV)

ER CONDITIONERS GREE MAKING BETTER CONDITIONERS GREE MAKING BETTER CONDITIONERS GREE MAKING BETTER CONDITIONERS

TECHNICAL SALES GUIDE-60Hz

CAPACITY RANGE: 72000Btu/h~360000Btu/h

SUPER HIGH AMBIENT OPERATION TO 125.6 °F

TER CONDITIONERS GREE MAKING BETTER CONDITIONERS GREE MAKING BETTER CONDITIONERS GREE MAKING BETTER CONDITIONERS



R410A

GREE ELECTRIC APPLIANCES INC.OF ZHUHAI

CONTENTS

1 UNIT CHARACTERISTICS	1
2 UNIT PARAMETERS	8
3 ELECTRICAL SPECIFICATIONS.....	16
4 COMBINATION MODE.....	18
5 INTERNAL PIPING DESIGN OF THE UNITS	20
6 UNIT CAPACITY CORRECTION	24
7 UNIT NOISE CURVES	72
8 UNIT GRAVITY CENTER DIAGRAMS	74
9 UNIT INSTALLATION SPACE REQUIREMENTS	76
10 MODEL SELECTION FOR UNIT PIPING.....	82
11 REQUIREMENTS FOR COMMUNICATION MODE	94
12 ELECTRICAL CONNECTION.....	102
13 CALCULATION METHOD OF REFRIGERANT ADDED FOR ENGINEERING PIPING	104
14 PRECAUTIONS ON REFRIGERANT LEAKAGE.....	105
15 OPTIONAL COMPONENTS.....	106
16 UNIT OPERATING RANGE	106



1 UNIT CHARACTERISTICS

1.1 Lineup of Outdoor Unit

1.1.1 GMV-***WM/B-F(U) and GMV-***WM/B1-F(U)



GMV5 series DC inverter VRF units: The basic models of the whole series are 6Ton, 8Ton, 10Ton, 12Ton, 14Ton and the combination model is 12Ton-30Ton.

Refrigeration Capacity/HP	Model	Combination Mode	Appearance
6	GMV-72WM/B-F(U)	-	
8	GMV-96WM/B-F(U)	-	
10	GMV-120WM/B-F(U)	-	
12	GMV-144WM/B1-F(U)	-	
14	GMV-168WM/B1-F(U)	-	
12	GMV-144WM/B-F(U)	GMV-72WM/B-F(U) + GMV-72WM/B-F(U)	
14	GMV-168WM/B-F(U)	GMV-72WM/B-F(U) + GMV-96WM/B-F(U)	

Refrigeration Capacity/HP	Model	Combination Mode	Appearance
16	GMV-192WM/B-F(U)	GMV-96WM/B-F(U) + GMV-96WM/B-F(U)	
18	GMV-216WM/B-F(U)	GMV-96WM/B-F(U) + GMV-120WM/B-F(U)	
20	GMV-240WM/B-F(U)	GMV-120WM/B-F(U) + GMV-120WM/B-F(U)	
22	GMV-264WM/B-F(U)	GMV-72WM/B-F(U) + GMV-96WM/B-F(U) + GMV-96WM/B-F(U)	
24	GMV-288WM/B-F(U)	GMV-96WM/B-F(U) + GMV-96WM/B-F(U) + GMV-96WM/B-F(U)	
26	GMV-312WM/B-F(U)	GMV-96WM/B-F(U) + GMV-96WM/B-F(U) + GMV-120WM/B-F(U)	
28	GMV-336WM/B-F(U)	GMV-96WM/B-F(U) + GMV-120WM/B-F(U) + GMV-120WM/B-F(U)	
30	GMV-360WM/B-F(U)	GMV-120WM/B-F(U) + GMV-120WM/B-F(U) + GMV-120WM/B-F(U)	

1.1.2 GMV-***WM/B-U(U)

GMV5 series DC inverter VRF units: The basic models of the whole series are 6Ton, 8Ton, 10Ton and the combination model is 12Ton-30Ton.

Refrigeration Capacity/Ton	Model	Combination Mode	Appearance
6	GMV-72WM/B-U(U)	-	
8	GMV-96WM/B-U(U)	-	
10	GMV-120WM/B-U(U)	-	

Refrigeration Capacity/Ton	Model	Combination Mode	Appearance
12	GMV-144WM/B-U(U)	GMV-72WM/B-U(U) + GMV-72WM/B-U(U)	
14	GMV-168WM/B-U(U)	GMV-72WM/B-U(U) + GMV-96WM/B-U(U)	
16	GMV-192WM/B-U(U)	GMV-96WM/B-U(U) + GMV-96WM/B-U(U)	
18	GMV-216WM/B-U(U)	GMV-96WM/B-U(U) + GMV-120WM/B-U(U)	
20	GMV-240WM/B-U(U)	GMV-120WM/B-U(U) + GMV-120WM/B-U(U)	
22	GMV-264WM/B-U(U)	GMV-72WM/B-U(U) + GMV-96WM/B-U(U) + GMV-96WM/B-U(U)	
24	GMV-288WM/B-U(U)	GMV-96WM/B-U(U) + GMV-96WM/B-U(U) + GMV-96WM/B-U(U)	
26	GMV-312WM/B-U(U)	GMV-96WM/B-U(U) + GMV-96WM/B-U(U) + GMV-120WM/B-U(U)	
28	GMV-336WM/B-U(U)	GMV-96WM/B-U(U) + GMV-120WM/B-U(U) + GMV-120WM/B-U(U)	
30	GMV-360WM/B-U(U)	GMV-120WM/B-U(U) + GMV-120WM/B-U(U) + GMV-120WM/B-U(U)	

1.2 Product Functions and Features

Energy efficient

The products benefit from the advanced DC inverter technology, optimized air conditioner system design, and accurate intelligent control technology.

High efficient DC inverter compressor

The DC inverter compressor is adopted for Gree DC inverter VRF units. The compressor is designed in

the high pressure chamber with excellent performance to suck directly, reduce the suction superheat loss and increase the compression efficiency by 3% in comparison to the low pressure chamber compression. The motor part adopts a high efficient permanent magnet synchronous motor, the rotor is a permanent magnet, and the stator implements concentrated winding. Therefore, the efficiency far surpasses that of a common DC inverter compressor.

➤ **Sensorless DC inverter fan motor**

The DC convertor motor with a high back electromotive force is adopted to implement stepless speed regulation in the range of 5 Hz to 65 Hz. In contrast to the common DC convertor motor, both the operating current and motor input power are lower, but the efficiency is greatly improved.

➤ **Advanced torque control technology**

The technology of minimum current and maximum torque control is adopted.

The rotor reluctance torque of DC inverter compressor is effectively used to export the maximum torque at the cost of minimum current, thus reducing the motor winding loss and achieving higher energy efficiency.

The low frequency torque control is implemented.

The motor torque is directly controlled to realize operation of the DC inverter at an ultralow speed. The small torque pulsation not only meets system requirements, but also guarantees the higher degree of comfort.

➤ **Comfortable mute**

Gree GMV5 air conditioning units fully consider the comfort requirement of people, and the humanized technology further perfects the degree of comfort. The wider operation range of the units ensures normal operation in sub-zero weather or hot weather. The better mute effect creates a quiet environment for work and life.

➤ **Outdoor unit mute mode**

◆ **Night mute**

The system can memorize and judge the outdoor maximum temperature. When the system operates with a low load at night, it can automatically enter the mute mode. Nine mute modes can be set for the units according to requirements of actual application scenarios.

For example, the unit can automatically enters the night operation mode after operation for 8h, and will restore the normal operation mode in 9h.

◆ **Forced mute**

When the unit is installed at a place with the requirement for a lower noise level, it should operate in the mute mode in the daytime and at night. In this case, three forced mute setting modes can be selected to ensure that the unit operates at the low noise mode all the time. The minimum noise value can be 45dB (A).

➤ **Indoor unit mute mode**

The indoor unit also adopts the DC inverter motor to implement stepless speed regulation and greatly reduce the noise level. Moreover, the wired controller can be used to set the automatic mute mode of indoor unit and enable the automatic mute function according to the indoor temperature and movements of persons. The minimum noise value can be 25dB (A).

➤ **Advanced technology to ensure stability and reliability**

Gree GMV5 air conditioning units have earned a reputation in the field due to the high technical content. Thanks to research and experiments for more than one decade, all the technologies of GMV have become more matured. Gree GMV5 has been upgraded in an all-round way, including electric elements, machine elements, control technology and communication technology. Continuous revolution in technologies must bring more reliable and efficient service to users.

➤ **Two-stage oil separation technology**

For the patented two-stage oil separation technology (patent No. 201120003910.7), every basic module is provided with stage-1 and stage-2 oil separators. Stage-1 oil separator uses a filter

expansion valve, and the separation efficiency reaches 98%. Stage-2 oil separator further separates 2% of refrigeration oil left, and the separation efficiency reaches 95%. The total oil separation efficiency reaches 99.9%.

➤ Oil return control technologies

Gree owns two major unique oil return control technologies.

◆ Oil return control of new generation

Gree oil return control technology of new generation integrates the pressure control oil return technology. Pressure control effectively controls oil return of the system and the oil storage status of each compressor, thus substantially increasing the service life of the compressor.

◆ Proprietary compressor oil storage technology

Gree DC inverter unit is designed with the proprietary compressor oil storage technology. The relevant parameter is judged to control the lowest oil level required for operating the compressor.

➤ Refrigerant storage and distribution technology

Gree GMV5 adopts the system loop without any reservoir to greatly reduce the refrigerant filling quantity, improve the refrigerant control precision of the system, and store the surplus refrigerant in the pipeline.

➤ Oil balance control technology

◆ Inter-module oil balance technology (patent No. 200910041723.5)

The defect of traditional scheduled oil return is eliminated. Oil can be balanced without stopping the system. The technology can judge the operating status of each module and each compressor, calculate the oil reserve of the compressor, adjust the operating status of the compressor, and implement inter-module oil balance. It can ensure reliability and comfortability of the air conditioning system without affecting the capacity output of the system.

◆ Inter-compressor oil balance technology

Refrigerant is sucked into the compression chamber of the compressor through the air suction pipe, discharged to the fully-closed compressor cavity after being compressed, and then flows through the refrigerating system via the vent pipe. According to the principle of moving fluid mechanics and the oil quantity actually required during operation of the compressor, the technology decides the height of the oil balance pipe, controls the oil level in the oil pool, ensures the minimum oil quantity required by each compressor during operation, and implements oil balance between compressors.

➤ Super-cooling control technology is used for refrigeration to substantially reduce the cooling capacity attenuation.

The efficient heat exchange loop is used to implement heat exchanger and super-cooling control. The degree of super-cooling reaches 11°C.

The recooling loop is used to reach a temperature of 9°C and ensure the refrigerating and heating effects.

➤ Unique comfortability control

The outdoor unit is regulated using dual electronic expansion valves within the regulation range of 960 stages to accurately realize the flow control between the indoor unit module and outdoor unit module, so the system operates more stably.

➤ Heating can quickly start within 210s, and 100% heat output is provided at the first time.

➤ **Humanized engineering operation**

➤ The unit is characterized by automatic address allocation and non-polarity communication.

➤ The unit can perform automatic debugging and fault detection.

GMV5 has five automatic debugging functions.

- ◆ Automatically allocating indoor and outdoor unit addresses
- ◆ Automatically checking the quantities of indoor and outdoor units
- ◆ Automatically detecting internal faults of units

- ◆ Automatically starting debugging
- ◆ Judging pipeline exceptions in real time
- The units provide three emergency functions: module, compressor and fan.
- The units can recover refrigerants in two modes.

➤ **Intelligent management**

- The units are designed in the dual-energy saving operation modes. Along with penetration of energy conservation and emission reduction and increasingly strict requirements for power utilization in cities raised by the state, a lot of cities will issue corresponding power rationing measures in the peak of power consumption, especially in summer. Gree GMV5 air conditioning units provides two energy saving modes for users to select as needed and meets the requirements for off-peak power consumption and power brownout in cities.
 - ◆ Energy saving mode 1: When the unit is set to the automatic energy saving mode during operation, the system automatically adjusts and controls the target parameter according to the operating status, and greatly reduces power consumption of the whole system. The maximum energy saving ratio is 15%.
 - ◆ Energy saving mode 2: When the unit is set to the forced energy saving mode during operation, the system forcedly limits power output of the system. The maximum energy saving ratio is 20%.
- The unit is provided with the energy consumption analysis function and corresponding solution.
- The unit supports the emergency shutdown function. Without remote monitoring, the outdoor unit can directly intervene in the fire alarm linkage signal, and the whole system can stop immediately in case of an emergency to avoid more risk losses.
- The unit has the management function by area.

➤ **Ultra-long piping distance design, with the maximum piping length of 1000m**

In comparison to the traditional water chilling unit, the VRF unit shows the strength of simple and convenient engineering piping. Gree GMV5 inverter VRF unit more significantly displays the strength of actual engineering piping, and the air conditioning system can be flexibly applied to various buildings more simply and freely, reducing the engineering installation cost for users.

➤ **A single refrigerating system, able to connect to a maximum of 80 indoor units**

For most VRF units in the market, the single system can connect to a maximum of 64 units. Gree GMV5 can implement combination of module units and connect to a maximum of 80 indoor units (the quantity of connected units ranks first in the field). It is more applicable to large-sized commercial office buildings or aparthotels.

➤ **Wide operation range**

Operating temperature range: -5°C(23°F) to 52°C(125.6°F) for cooling; -20°C (-4°F) to 24°C (75.2°F) for heating.

➤ **Module switching control**

The module status automatically switches between modules every eight hours according to the operating status. This avoids long-term “waiting for work” of several modules and greatly improves reliability of the whole system.

➤ **High static pressure design of the outdoor unit to realize more flexible selection**

The unit is provided with four levels of static pressures (0 Pa, 30 Pa, 50 Pa, and 82 Pa) for regulation. The corresponding static pressure can be selected for the outdoor unit according to the building form, and the maximum static pressure is 82 Pa. The unit especially applies to the scenario where the outdoor unit needs to be placed indoors.

1.3 Nomenclature

GMV	□	-	□	□	□	□	□	W	□	/	□	□	□	(□)
1	2		3	4	5	6	7	8	9		10	11	12	13

No.	Description	Options
1	Product code	GMV—Gree Multi VRF Units
2	Suitable climate	Blank—T1 condition; T2—Low temperature climate; T3—High temperature climate
3	RAC or CAC	RAC—H CAC—Default
4	Special function	G—High sensible heat V—Low-temperature heat pump Default—Without special function
5	Unit type	DC inverter—Default Y—Solar power
6	Function code	Q—Heat Recovery; S—Water Heater; W—Water-cooled Unit; X—Fresh Air Unit Z—Reheat dehumidifier Default—If above functions are unavailable.
7	Code of cooling capacity	Nominal capacity*1000(Btu/h)
8	Code for outdoor unit	W—Outdoor unit
9	Unit structure	M—Modular (top discharge); L—Non-modular (side discharge); Default—Non-modular (top discharge)
10	Refrigerant	R410A (omit)
11	Design No.	Named in order of A, B, C, or combined with 1, 2, 3...
12	Power supply	F—208/230V-3ph-60Hz; U—440/460V-3ph-60Hz; T—208/230V-1ph-60Hz
13	Special code	For special area; leave blank if it is not for special area

2 UNIT PARAMETERS

2.1 GMV-***WM/B-F(U) and GMV-***WM/B1-F(U)

Outdoor Units_Heat Pump		—	6Ton	8Ton	10Ton	12Ton	14Ton
Model		—	GMV-72WM/ B-F(U)	GMV-96WM/ B-F(U)	GMV-120WM/ B-F(U)	GMV-144WM/B1- F(U)	GMV-168WM/B1- F(U)
Cooling capacity		Btu/h	72000	96000	120000	144000	168000
Heating capacity		Btu/h	81000	108000	135000	162000	189000
Air volume		CFM	6710	8240	8240	8240	9416
Max. external static pressure		Pa	82	82	82	82	82
Noise (sound level)		dB(A)	60	61	63	64	65
Power		—	208/230V 3~ 60Hz	208/230V 3~ 60Hz	208/230V 3~ 60Hz	208/230V 3~ 60Hz	208/230V 3~ 60Hz
Input power for cooling		kW	5.45	7.30	10.00	12.00	14.00
Input power for heating		kW	5.80	7.85	10.50	12.50	14.25
Input current for cooling		A	16.42	20.37	26.27	39.2	45.7
Input current for heating		A	17.29	23.50	27.87	40.8	46.5
MOP		A	35	45	60	70	70
MCA		A	31	37	50	55	57
Compressor type		—	Inverter Scroll	Inverter Scroll	Inverter Scroll	Inverter Scroll	Inverter Scroll
Compressor quantity		N	1	1	2	2	2
Refrigeration oil no. of compressor		—	FVC68D or FV68H	FVC68D or FV68H	FVC68D or FV68H	FVC68D or FV68H	FVC68D or FV68H
Oil Charge	Compressor	L	1.1	1.1	1.1+0.5	1.1+1.1	1.1+1.1
	Oil separate tank	L	3.5	4	5	5	5
	Total	L	4.6	5.1	6.6	7.2	7.2
Ambient temperature range for cooling		°F	23~125.6	23~125.6	23~125.6	23~125.6	23~125.6
Ambient temperature range of heating		°F	-4~75	-4~75	-4~75	-4~75	-4~75
Refrigerant type		—	R410A	R410A	R410A	R410A	R410A
Charging volume of refrigerant		oz	229.3	398.7	412.7	412.7	412.7
Max. quantity of connected indoor unit		unit	13	16	19	23	29
Size of gas pipe		in.	Φ3/4	Φ7/8	Φ1-1/8	Φ1-1/8	Φ1-1/8
Size of liquid pipe		in.	Φ3/8	Φ3/8	Φ1/2	Φ1/2	Φ5/8
Size of oil-balanced pipe		in.	Φ3/8	Φ3/8	Φ3/8	Φ3/8	Φ3/8
Outline dimension(W×D×H)		in.	36-5/8×30- 1/8×63-1/4	52-3/4×30- 1/8×63-1/4	52-3/4×30- 1/8×63-1/4	52-3/4×30- 1/8×63-1/4	52-3/4×30- 1/8×68-1/2
Packing size(W×D×H)		in.	39-3/4×33- 1/8×69-7/8	55-7/8×33- 1/8×69-7/8	55-7/8×33- 1/8×69-7/8	55-7/8×33- 1/8×69-7/8	55-7/8×33- 1/8×75-1/4
Net weight		LBS	496	662	794	794	849
Gross weight		LBS	518	695	827	827	882

GMV5 DC Inverter VRF Units Technical Sales Guide

Outdoor Units_Heat Pump	—	12Ton	14Ton	16Ton
Model	—	GMV-144WM/B-F(U)	GMV-168WM/B-F(U)	GMV-192WM/B-F(U)
Module (combined)	—	GMV-72WM/B-F(U)+ GMV-72WM/B-F(U)	GMV-72WM/B-F(U)+GMV- 96WM/B-F(U)	GMV-96WM/B-F(U)+ GMV-96WM/B-F(U)
Cooling capacity	Btu/h	144000	168000	192000
Heating capacity	Btu/h	162000	189000	216000
Air volume	CFM	6710+6710	6710+8240	8240+8240
Max. external static pressure	Pa	82	82	82
Power	—	208/230V 3~ 60Hz	208/230V 3~ 60Hz	208/230V 3~ 60Hz
Input power for cooling	kW	5.45+5.45	5.45+7.3	7.3+7.3
Input power for heating	kW	5.80+5.80	5.80+7.85	7.85+7.85
Input current for cooling	A	16.42+16.42	16.42+20.37	20.37+20.37
Input current for heating	A	17.29+17.29	17.29+23.50	23.50+23.50
MOP	A	35+35	35+45	45+45
MCA	A	31+31	31+37	37+37
Refrigeration oil no. of compressor	—	FVC68D or FV68H	FVC68D or FV68H	FVC68D or FV68H
Ambient temperature range for cooling	°F	23~125.6	23~125.6	23~125.6
Ambient temperature range of heating	°F	-4~75	-4~75	-4~75
Refrigerant type	—	R410A	R410A	R410A
Charging volume of refrigerant	oz	229.3+229.3	229.3+398.7	398.7+398.7
Max. quantity of connected indoor unit	unit	23	29	33
Size of gas pipe	in.	Φ1-1/8	Φ1-1/8	Φ1-1/8
Size of liquid pipe	in.	Φ1/2	Φ5/8	Φ5/8
Size of oil-balanced pipe	in.	Φ3/8	Φ3/8	Φ3/8
Outline dimension(W×D×H)	in.	(36-5/8×30-1/8×63- 1/4)×2	(36-5/8×30-1/8×63-1/4) +(52-3/4×30-1/8×63-1/4)	(52-3/4×30-1/8×63- 1/4)×2
Packing size(W×D×H)	in.	/	/	/
Net weight	LBS	496+496	496+662	662+662
Gross weight	LBS	518+518	518+695	695+695

Outdoor Units_Heat Pump	—	18Ton	20Ton	22Ton
Model	—	GMV-216WM/B-F(U)	GMV-240WM/B-F(U)	GMV-264WM/B-F(U)
Module (combined)	—	GMV-96WM/B-F(U)+ GMV-120WM/B-F(U)	GMV-120WM/B-F(U)+ GMV-120WM/B-F(U)	GMV-72WM/B-F(U)+ GMV-96WM/B-F(U)+ GMV-96WM/B-F(U)
Cooling capacity	Btu/h	216000	240000	264000
Heating capacity	Btu/h	243000	270000	297000
Air volume	CFM	8240+8240	8240+8240	6710+8240+8240
Max. external static pressure	Pa	82	82	82
Power	—	208/230V 3~ 60Hz	208/230V 3~ 60Hz	208/230V 3~ 60Hz
Input power for cooling	kW	7.30+10.00	10.00+10.00	5.45+7.3+7.3
Input power for heating	kW	7.85+10.50	10.50+10.50	5.80+7.85+7.85
Input current for cooling	A	20.37+26.27	26.27+26.27	16.42+20.37+20.37
Input current for heating	A	23.50+27.87	27.87+27.87	17.29+23.50+23.50
MOP	A	45+60	60+60	35+45+45
MCA	A	37+50	50+50	31+37+37
Refrigeration oil no. of compressor	—	FVC68D or FV68H	FVC68D or FV68H	FVC68D or FV68H
Ambient temperature range for cooling	°F	23~125.6	23~125.6	23~125.6
Ambient temperature range of heating	°F	-4~75	-4~75	-4~75
Refrigerant type	—	R410A	R410A	R410A
Charging volume of refrigerant	oz	398.7+412.7	412.7+412.7	229.3+398.7+398.7
Max. quantity of connected indoor unit	unit	36	39	46
Size of gas pipe	in.	Φ1-1/8	Φ1-3/8	Φ1-3/8
Size of liquid pipe	in.	Φ5/8	Φ5/8	Φ3/4
Size of oil-balanced pipe	in.	Φ3/8	Φ3/8	Φ3/8
Outline dimension(W×D×H)	in.	(52-3/4×30-1/8×63-1/4)×2	(52-3/4×30-1/8×63-1/4)×2	(36-5/8×30-1/8×63-1/4)+ (52-3/4×30-1/8×63-1/4)×2
Net weight	LBS	662+794	794+794	496+662+662
Gross weight	LBS	695+827	827+827	518+695+695

GMV5 DC Inverter VRF Units Technical Sales Guide

Outdoor Units_Heat Pump	—	24Ton	26Ton	28Ton	30Ton
Model	—	GMV-288WM/B-F(U)	GMV-312WM/B-F(U)	GMV-336WM/B-F(U)	GMV-360WM/B-F(U)
Module (combined)	—	GMV-96WM/B-F(U)+ GMV-96WM/B-F(U)+ GMV-96WM/B-F(U)	GMV-96WM/B-F(U)+ GMV-96WM/B-F(U)+ GMV-120WM/B-F(U)	GMV-96WM/B-F(U)+ GMV-120WM/ B-F(U)+ GMV-120WM/B-F(U)	GMV-120WM/ B-F(U)+ GMV-120WM/ B-F(U)+ GMV-120WM/B-F(U)
Cooling capacity	Btu/h	288000	312000	336000	360000
Heating capacity	Btu/h	324000	351000	378000	405000
Air volume	CFM	8240+8240+8240	8240+8240+8240	8240+8240+8240	8240+8240+8240
Max. external static pressure	Pa	82	82	82	82
Power	—	208/230V 3~ 60Hz	208/230V 3~ 60Hz	208/230V 3~ 60Hz	208/230V 3~ 60Hz
Input power for cooling	kW	7.30+7.30+7.30	7.30+7.30+10.00	7.30+10.00+10.00	10.00+10.00+10.00
Input power for heating	kW	7.85+7.85+7.85	7.85+7.85+10.50	7.85+10.50+10.50	10.50+10.50+10.50
Input current for cooling	A	20.37+20.37+20.37	20.37+20.37+26.27	20.37+26.27+26.27	26.27+26.27+26.27
Input current for heating	A	23.50+23.50+23.50	23.50+23.50+27.87	23.50+27.87+27.87	27.87+27.87+27.87
MOP	A	45+45+45	45+45+60	45+60+60	60+60+60
MCA	A	37+37+37	37+37+50	37+50+50	50+50+50
Refrigeration oil no. of compressor	—	FVC68D or FV68H	FVC68D or FV68H	FVC68D or FV68H	FVC68D or FV68H
Ambient temperature range for cooling	°F	23~125.6	23~125.6	23~125.6	23~125.6
Ambient temperature range of heating	°F	-4~75	-4~75	-4~75	-4~75
Refrigerant type	—	R410A	R410A	R410A	R410A
Charging volume of refrigerant	oz	398.7+398.7+398.7	398.7+398.7+412.7	398.7+412.7+412.7	412.7+412.7+412.7
Max. quantity of connected indoor unit	unit	50	53	56	59
Size of gas pipe	in.	Φ1-3/8	Φ1-3/8	Φ1-3/8	Φ1-5/8
Size of liquid pipe	in.	Φ3/4	Φ3/4	Φ3/4	Φ3/4
Size of oil-balanced pipe	in.	Φ3/8	Φ3/8	Φ3/8	Φ3/8
Outline dimension(W×D×H)	in.	(52-3/4×30-1/8×63-1/4)×3	(52-3/4×30-1/8×63-1/4)×3	(52-3/4×30-1/8×63-1/4)×3	(52-3/4×30-1/8×63-1/4)×3
Packing size(W×D×H)	in.	/	/	/	/
Net weight	LBS	662+662+662	662+662+794	662+794+794	794+794+794
Gross weight	LBS	695+695+695	695+695+827	695+827+827	827+827+827
Maximum qty of connected indoor units	unit	50	53	56	59

2.2 GMV-***WM/B-U(U)

Outdoor Units_Heat Pump		—	6Ton	8Ton	10Ton
Model		—	GMV-72WM/B-U(U)	GMV-96WM/B-U(U)	GMV-120WM/B-U(U)
Cooling capacity	Btu/h		72000	96000	120000
Heating capacity	Btu/h		81000	108000	135000
Air volume	CFM		6710	8240	8240
Max. external static pressure	Pa		82	82	82
Noise (sound level)	dB(A)		60	61	63
Power	—		460V 3~ 60Hz	460V 3~ 60Hz	460V 3~ 60Hz
Input power for cooling	kW		5.45	7.30	10.00
Input power for heating	kW		5.80	7.85	10.50
Input current for cooling	A		8.05	10.78	14.77
Input current for heating	A		8.56	11.59	15.50
MOP	A		20	25	30
MCA	A		15	18	25
Compressor type	—		Inverter Scroll	Inverter Scroll	Inverter Scroll
Compressor quantity	N		1	1	2
Refrigeration oil no. of compressor	—		FVC68D or FV68H	FVC68D or FV68H	FVC68D or FV68H
Oil Charge	Compressor	L	1.1	1.1	1.1+0.5
	Oil separate tank	L	3.5	4	5
	Total	L	4.6	5.1	6.6
Ambient temperature range for cooling	°F		23~125.6	23~125.6	23~125.6
Ambient temperature range of heating	°F		-4~75	-4~75	-4~75
Refrigerant type	—		R410A	R410A	R410A
Charging volume of refrigerant	oz		229.3	398.7	412.7
Max. quantity of connected indoor unit	unit		13	16	19
Size of gas pipe	in.		Φ3/4	Φ7/8	Φ1-1/8
Size of liquid pipe	in.		Φ3/8	Φ3/8	Φ1/2
Size of oil-balanced pipe	in.		Φ3/8	Φ3/8	Φ3/8
Outline dimension(W×D×H)	in.		36-5/8×30-1/8×63-1/4	52-3/4×30-1/8×63-1/4	52-3/4×30-1/8×63-1/4
Packing size(W×D×H)	in.		39-3/4×33-1/8×69-7/8	55-7/8×33-1/8×69-7/8	55-7/8×33-1/8×69-7/8
Net weight	LBS		503	672	794
Gross weight	LBS		524	705	827

GMV5 DC Inverter VRF Units Technical Sales Guide

Outdoor Units_Heat Pump	—	12Ton	14Ton	16Ton
Model	—	GMV-144WM/B-U(U)	GMV-168WM/B-U(U)	GMV-192WM/B-U(U)
Module (combined)	—	GMV-72WM/B-U(U)+ GMV-72WM/B-U(U)	GMV-72WM/B-U(U)+ GMV-96WM/B-U(U)	GMV-96WM/B-U(U)+ GMV-96WM/B-U(U)
Cooling capacity	Btu/h	144000	168000	192000
Heating capacity	Btu/h	162000	189000	216000
Air volume	CFM	6710+6710	6710+8240	8240+8240
Max. external static pressure	Pa	82	82	82
Noise (sound level)	dB(A)	/	/	/
Power	—	460V 3~ 60Hz	460V 3~ 60Hz	460V 3~ 60Hz
Input power for cooling	kW	5.45+5.45	5.45+7.30	7.30+7.30
Input power for heating	kW	5.80+5.80	5.80+7.85	7.85+7.85
Input current for cooling	A	8.05+8.05	8.05+10.78	10.78+10.78
Input current for heating	A	8.56+8.56	8.56+11.59	11.59+11.59
MOP	A	20+20	20+25	25+25
MCA	A	15+15	15+18	18+18
Refrigeration oil no. of compressor	—	FVC68D or FV68H	FVC68D or FV68H	FVC68D or FV68H
Ambient temperature range for cooling	°F	23~125.6	23~125.6	23~125.6
Ambient temperature range of heating	°F	-4~75	-4~75	-4~75
Refrigerant type	—	R410A	R410A	R410A
Charging volume of refrigerant	oz	229.3+229.3	229.3+398.7	398.7+398.7
Max. quantity of connected indoor unit	unit	23	29	33
Size of gas pipe	in.	Φ1-1/8	Φ1-1/8	Φ1-1/8
Size of liquid pipe	in.	Φ1/2	Φ5/8	Φ5/8
Size of oil-balanced pipe	in.	Φ3/8	Φ3/8	Φ3/8
Outline dimension(W×D×H)	in.	(36-5/8×30-1/8×63-1/4)×2	(36-5/8×30-1/8×63-1/4) +(52-3/4×30-1/8×63-1/4)	(52-3/4×30-1/8×63-1/4)×2
Packing size(W×D×H)	in.	/	/	/
Net weight	LBS	503+503	503+672	672+672
Gross weight	LBS	524+524	524+705	705+705

Outdoor Units_Heat Pump	—	18Ton	20Ton	22Ton
Model	—	GMV-216WM/B-U(U)	GMV-240WM/B-U(U)	GMV-264WM/B-U(U)
Module (combined)	—	GMV-96WM/B-U(U)+ GMV-120WM/B-U(U)	GMV-120WM/B-U(U)+ GMV-120WM/B-U(U)	GMV-72WM/B-U(U)+ GMV-96WM/B-U(U)+ GMV-96WM/B-U(U)
Cooling capacity	Btu/h	216000	240000	260000
Heating capacity	Btu/h	243000	270000	297000
Air volume	CFM	8240+8240	8240+8240	6710+8240+8240
Max. external static pressure	Pa	82	82	82
Noise (sound level)	dB(A)	/	/	/
Power	—	460V 3~ 60Hz	460V 3~ 60Hz	460V 3~ 60Hz
Input power for cooling	kW	7.30+10.00	10.00+10.00	5.45+7.30+7.30
Input power for heating	kW	7.85+10.50	10.50+10.50	5.80+7.85+7.85
Input current for cooling	A	10.78+14.77	14.77+14.77	8.05+10.78+10.78
Input current for heating	A	11.59+15.50	15.50+15.50	8.56+11.59+11.59
MOP	A	25+30	30+30	20+25+25
MCA	A	18+25	25+25	15+18+18
Refrigeration oil no. of compressor	—	FVC68D or FV68H	FVC68D or FV68H	FVC68D or FV68H
Ambient temperature range for cooling	°F	23~125.6	23~125.6	23~125.6
Ambient temperature range of heating	°F	-4~75	-4~75	-4~75
Refrigerant type	—	R410A	R410A	R410A
Charging volume of refrigerant	oz	398.7+412.7	412.7+412.7	229.3+398.7+398.7
Max. quantity of connected indoor unit	unit	36	39	46
Size of gas pipe	in.	Φ1-1/8	Φ1-3/8	Φ1-3/8
Size of liquid pipe	in.	Φ5/8	Φ5/8	Φ3/4
Size of oil-balanced pipe	in.	Φ3/8	Φ3/8	Φ3/8
Outline dimension(W×D×H)	in.	(52-3/4×30-1/8×63-1/4)×2	(52-3/4×30-1/8×63-1/4)×2	(36-5/8×30-1/8×63-1/4)+ (52-3/4×30-1/8×63-1/4)×2
Packing size(W×D×H)	in.	/	/	/
Net weight	LBS	672+794	794+794	503+672+672
Gross weight	LBS	705+827	827+827	524+705+705

GMV5 DC Inverter VRF Units Technical Sales Guide

Outdoor Units_Heat Pump	—	24Ton	26Ton	28Ton	30Ton
Model	—	GMV-288WM/B-U(U)	GMV-312WM/B-U(U)	GMV-336WM/B-U(U)	GMV-360WM/B-U(U)
Module (combined)	—	GMV-96WM/B-U(U)+ GMV-96WM/B-U(U)+ GMV-96WM/B-U(U)	GMV-96WM/B-U(U)+ GMV-96WM/B-U(U)+ GMV-120WM/B-U(U)	GMV-96WM/B-U(U)+ GMV-120WM/B-U(U)+ GMV-120WM/B-U(U)	GMV-120WM/B-U(U)+ GMV-120WM/B-U(U)+ GMV-120WM/B-U(U)
Cooling capacity	Btu/h	288000	312000	336000	360000
Heating capacity	Btu/h	324000	351000	378000	405000
Air volume	CFM	8240+8240+8240	8240+8240+8240	8240+8240+8240	8240+8240+8240
Max. external static pressure	Pa	82	82	82	82
Noise (sound level)	dB(A)	/	/	/	/
Power	—	460V 3~ 60Hz	460V 3~ 60Hz	460V 3~ 60Hz	460V 3~ 60Hz
Input power for cooling	kW	7.30+7.30+7.30	7.30+7.30+10.00	7.30+10.00+10.00	10.00+10.00+10.00
Input power for heating	kW	7.85+7.85+7.85	7.85+7.85+10.50	7.85+10.50+10.50	10.50+10.50+10.50
Input current for cooling	A	10.78+10.78+10.78	10.78+10.78+14.77	10.78+14.77+14.77	14.77+14.77+14.77
Input current for heating	A	11.59+11.59+11.59	11.59+11.59+15.50	11.59+15.50+15.50	15.50+15.50+15.50
MOP	A	25+25+25	25+25+30	25+30+30	30+30+30
MCA	A	18+18+18	18+18+25	18+25+25	25+25+25
Refrigeration oil no. of compressor	—	FVC68D or FV68H	FVC68D or FV68H	FVC68D or FV68H	FVC68D or FV68H
Ambient temperature range for cooling	°F	23~125.6	23~125.6	23~125.6	23~125.6
Ambient temperature range of heating	°F	-4~75	-4~75	-4~75	-4~75
Refrigerant type	—	R410A	R410A	R410A	R410A
Charging volume of refrigerant	oz	398.7+398.7+398.7	398.7+398.7+412.7	398.7+412.7+412.7	412.7+412.7+412.7
Max. quantity of connected indoor unit	unit	50	53	56	59
Size of gas pipe	in.	Φ1-3/8	Φ1-3/8	Φ1-3/8	Φ1-5/8
Size of liquid pipe	in.	Φ3/4	Φ3/4	Φ3/4	Φ3/4
Size of oil-balanced pipe	in.	Φ3/8	Φ3/8	Φ3/8	Φ3/8
Outline dimension(W×D×H)	in.	(52-3/4×30-1/8×63-1/4)×3	(52-3/4×30-1/8×63-1/4)×3	(52-3/4×30-1/8×63-1/4)×3	(52-3/4×30-1/8×63-1/4)×3
Packing size(W×D×H)	in.	/	/	/	/
Net weight	LBS	672+672+672	672+672+794	672+794+794	794+794+794
Gross weight	LBS	705+705+705	705+705+827	705+827+827	827+827+827

NOTICES:

(1) Rated Capacity=Rated in accordance with AHRI Standard 1230.

Nominal Capacity=Outside the scope of AHRI Standard 1230 and base on the follow conditions:

Cooling:indoor temp.80°F(26.7°C) DB/67°F(19.4°C)WB, outdoor temp.95°F(35°C) DB.

Heating:indoor temp.70°F(21.1°C) DB, outdoor temp.47°F(8.3°C) DB/43°F(6.1 °C) WB.

Piping length: 25ft(7.6) m, without height drop between units.

(2)The total capacity of connected indoor units must be in the range of 50%~135% of the outdoor unit capacity. The relevant parameters can be corrected by referring to the unit capacity correction table.

(3)Wiring cable size must comply with the applicable and national code.

(4)Due to continuing improvement,above specifications may be subject to change without notice.

(5) Conversion Formula:

$$\text{kcal/h}=\text{kW}\times 860$$

$$\text{Btu/h}=\text{kW}\times 3412$$

$$\text{CFM}=\text{m}^3/\text{h}\times 0.588$$

$$\text{lb}=\text{kg}/0.4536$$

3 ELECTRICAL SPECIFICATIONS

Circuit Breaker and Wire Diameter Selection of GMV5 Series Units

3.1 GMV-***WM/B-F(U) and GMV-***WM/B1-F(U)

Outdoor units	Power Supply	Fuse Capacity	Minimum Circuit Ampacity	Maximum Overcurrent Protection
	V/ Ph /Hz	A	A	A
GMV-72WM/B-F(U)	208V/230V 3~ 60Hz	35	31	35
GMV-96WM/B-F(U)	208V/230V 3~ 60Hz	45	37	45
GMV-120WM/B-F(U)	208V/230V 3~ 60Hz	60	50	60
GMV-144WM/B1-F(U)	208V/230V 3~ 60Hz	70	55	70
GMV-168WM/B1-F(U)	208V/230V 3~ 60Hz	70	57	70
GMV-144WM/B-F(U)	208V/230V 3~ 60Hz	35+35	31+31	35+35
GMV-168WM/B-F(U)	208V/230V 3~ 60Hz	35+45	31+37	35+45
GMV-192WM/B-F(U)	208V/230V 3~ 60Hz	45+45	37+37	45+45
GMV-216WM/B-F(U)	208V/230V 3~ 60Hz	45+60	37+50	45+60
GMV-240WM/B-F(U)	208V/230V 3~ 60Hz	60+60	50+50	60+60
GMV-264WM/B-F(U)	208V/230V 3~ 60Hz	35+45+45	31+37+37	35+45+45
GMV-288WM/B-F(U)	208V/230V 3~ 60Hz	45+45+45	37+37+37	45+45+45
GMV-312WM/B-F(U)	208V/230V 3~ 60Hz	45+45+60	37+37+50	45+45+60
GMV-336WM/B-F(U)	208V/230V 3~ 60Hz	45+60+60	37+50+50	45+60+60
GMV-360WM/B-F(U)	208V/230V 3~ 60Hz	60+60+60	50+50+50	60+60+60

3.2 GMV-***WM/B-U(U)

Outdoor units	Power Supply	Fuse Capacity	Minimum Circuit Ampacity	Maximum Overcurrent Protection
	V/ Ph /Hz	A	A	A
GMV-72WM/B-U(U)	460V 3~ 60Hz	20	15	20
GMV-96WM/B-U(U)	460V 3~ 60Hz	25	18	25
GMV-120WM/B-U(U)	460V 3~ 60Hz	30	25	30
GMV-144WM/B-U(U)	460V 3~ 60Hz	20+20	15+15	20+20
GMV-168WM/B-U(U)	460V 3~ 60Hz	20+25	15+18	20+25
GMV-192WM/B-U(U)	460V 3~ 60Hz	25+25	18+18	25+25
GMV-216WM/B-U(U)	460V 3~ 60Hz	25+30	18+25	25+30
GMV-240WM/B-U(U)	460V 3~ 60Hz	30+30	25+25	30+30
GMV-264WM/B-U(U)	460V 3~ 60Hz	20+25+25	15+18+18	20+25+25
GMV-288WM/B-U(U)	460V 3~ 60Hz	25+25+25	18+18+18	25+25+25
GMV-312WM/B-U(U)	460V 3~ 60Hz	25+25+30	18+18+25	25+25+30
GMV-336WM/B-U(U)	460V 3~ 60Hz	25+30+30	18+25+25	25+30+30
GMV-360WM/B-U(U)	460V 3~ 60Hz	30+30+30	25+25+25	30+30+30

NOTICES:



















- (1) Specification of circuit breaker and power cord is selected on the basis of unit's maximum power (max. current).
- (2) Specification of power cord is based on the working condition where ambient temperature is 40 °C (104°F) and multi-core cable with copper conductor(working temperature is 90°C (194°F), e.g. power cable with YJV cross-linked copper, insulated PE and PVC sheath) is lying on the surface of slot. If working condition is different, please adjust the specification according to national standard.
- (3) Copper-core cable must be used.
- (4) The above sectional area is suitable for a maximum distance of 15m(49-1/5ft.). If it's over 15m(49-1/5ft.), sectional area must be expanded to prevent overload current from burning the wire or causing fire hazard.
- (5) Specification of circuit breaker is based on the working condition where the ambient temperature of circuit breaker is 40°C(104°F). If working condition is different, please adjust the specification according to national standard.
- (6) The air switch should include magnetic trip function and thermal trip function so that system can be protected from short circuit and overload.
- (7) An all-pole disconnection switch having a contact separation of at least 3mm(1/8in.) in all poles should be connected in fixed wiring.

4 COMBINATION MODE

4.1 GMV-***WM/B-F(U) and GMV-***WM/B1-F(U)

Model	GMV-72WM/B-F(U)	GMV-96WM/B-F(U)	GMV-120WM/B-F(U)	GMV-144WM/B1-F(U)	GMV-168WM/B1-F(U)
GMV-72WM/B-F(U)					
GMV-96WM/B-F(U)					
GMV-120WM/B-F(U)					
GMV-144WM/B1-F(U)					
GMV-168WM/B1-F(U)					
GMV-144WM/B-F(U)					
GMV-168WM/B-F(U)					
GMV-192WM/B-F(U)					
GMV-216WM/B-F(U)					
GMV-240WM/B-F(U)					
GMV-264WM/B-F(U)					
GMV-288WM/B-F(U)					
GMV-312WM/B-F(U)					
GMV-336WM/B-F(U)					
GMV-360WM/B-F(U)					

4.2 GMV-***WM/B-U(U)

Model	GMV-72WM/B-U(U)	GMV-96WM/B-U(U)	GMV-120WM/B-U(U)
GMV-72WM/B-U(U)			
GMV-96WM/B-U(U)			
GMV-120WM/B-U(U)			
GMV-144WM/B-U(U)			
GMV-168WM/B-U(U)			
GMV-192WM/B-U(U)			
GMV-216WM/B-U(U)			
GMV-240WM/B-U(U)			
GMV-264WM/B-U(U)			
GMV-288WM/B-U(U)			
GMV-312WM/B-U(U)			
GMV-336WM/B-U(U)			
GMV-360WM/B-U(U)			

5 INTERNAL PIPING DESIGN OF THE UNITS

1. Piping diagrams of GMV-72WM/B-F(U), GMV-96WM/B-F(U), GMV-72WM/B-U(U) and GMV-96WM/B-U(U):

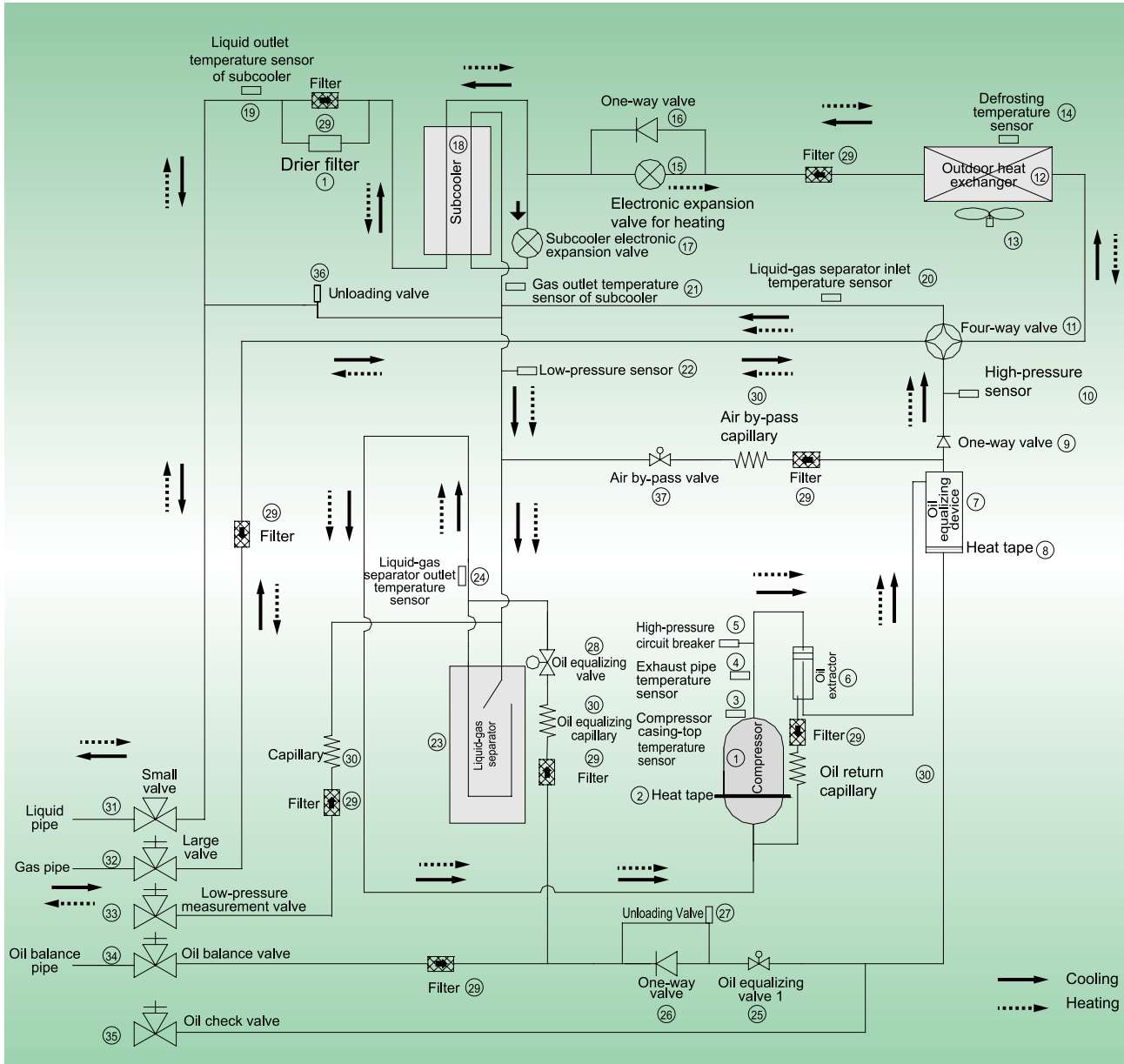

2. Piping diagrams of GMV-120WM/B-F(U) and GMV-120WM/B-U(U) :

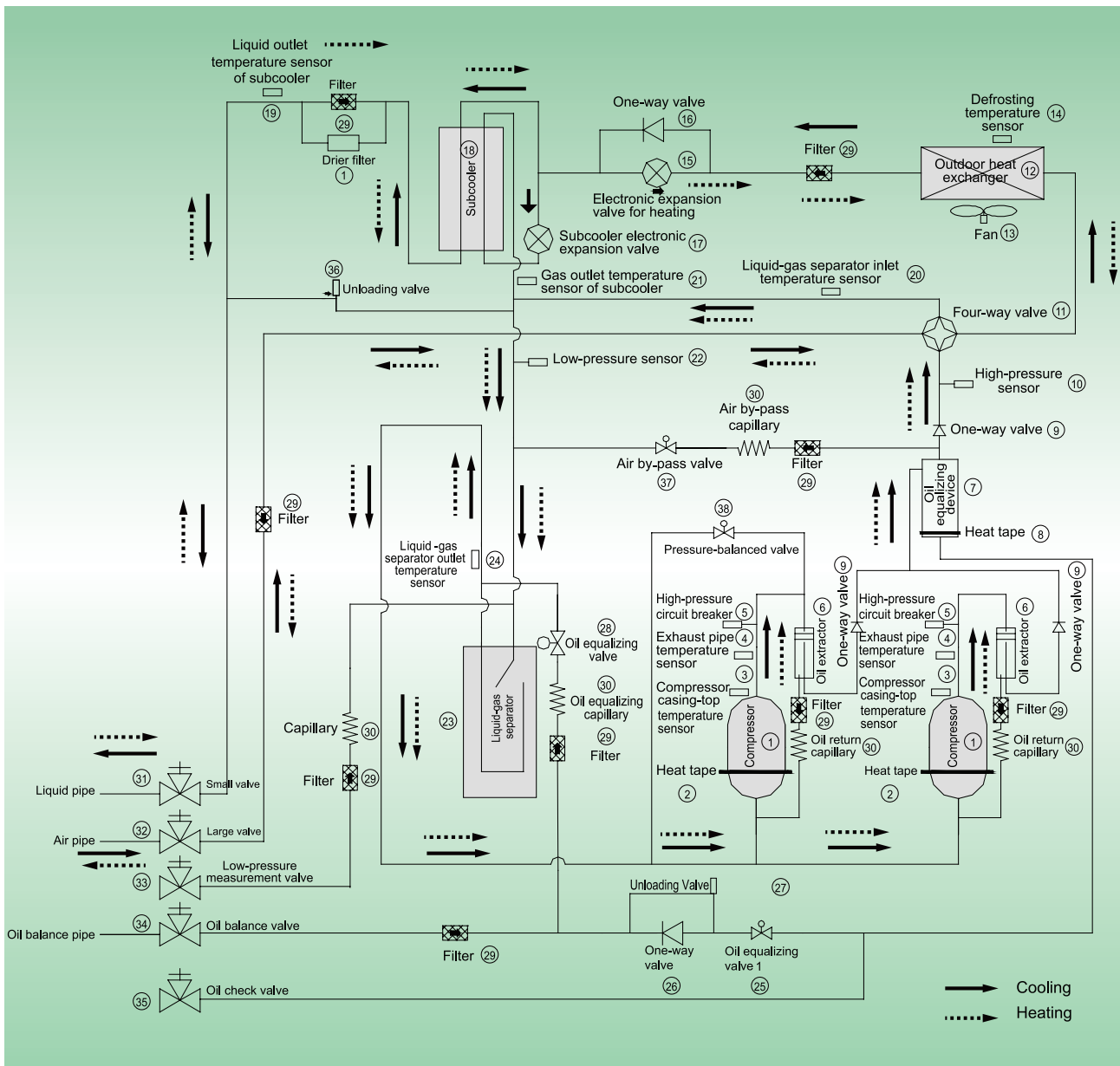

3. Piping diagrams of GMV-144WM/B1-F(U):

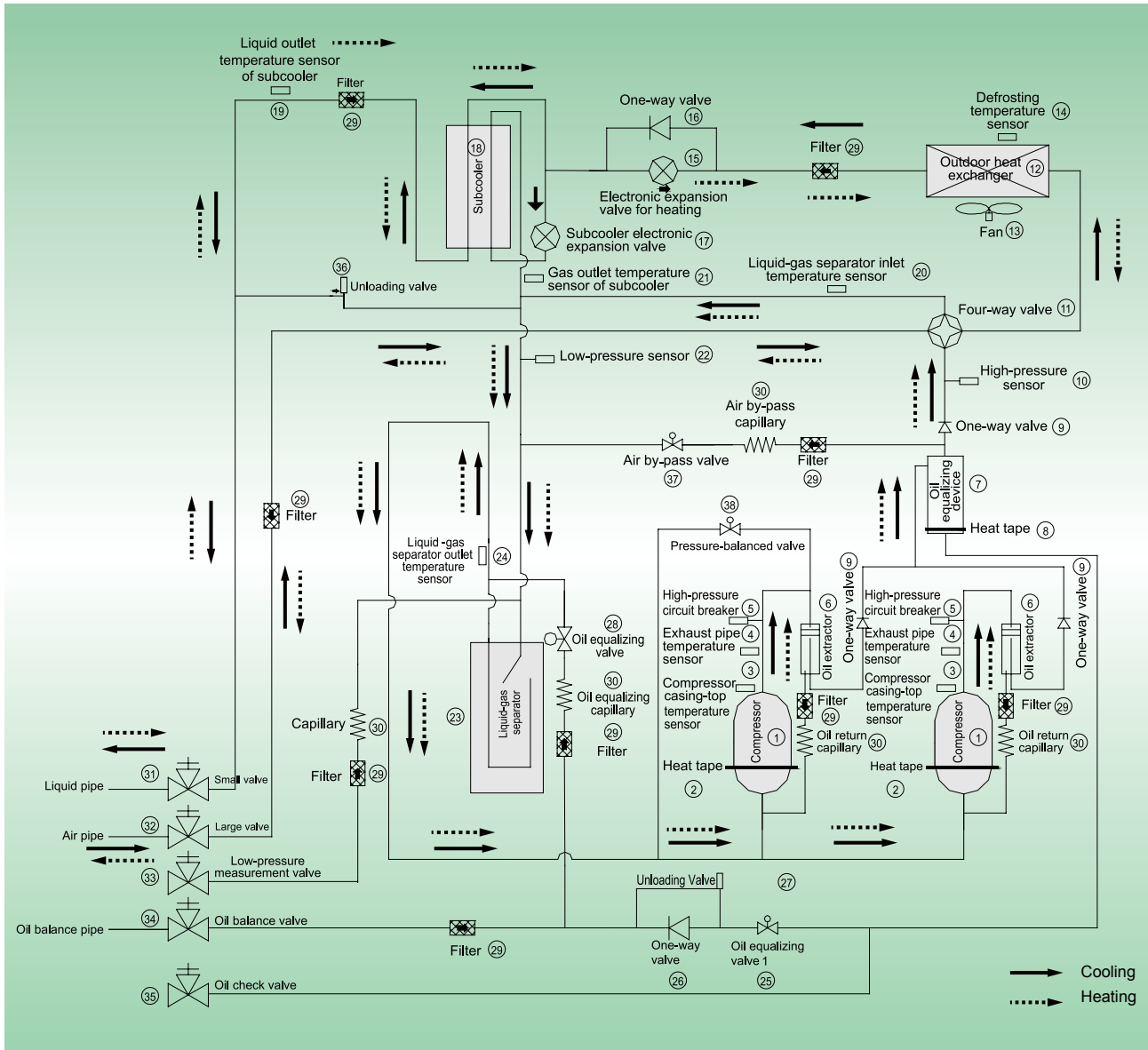

4.Piping Diagram of GMV-168WM/B1-F(U):

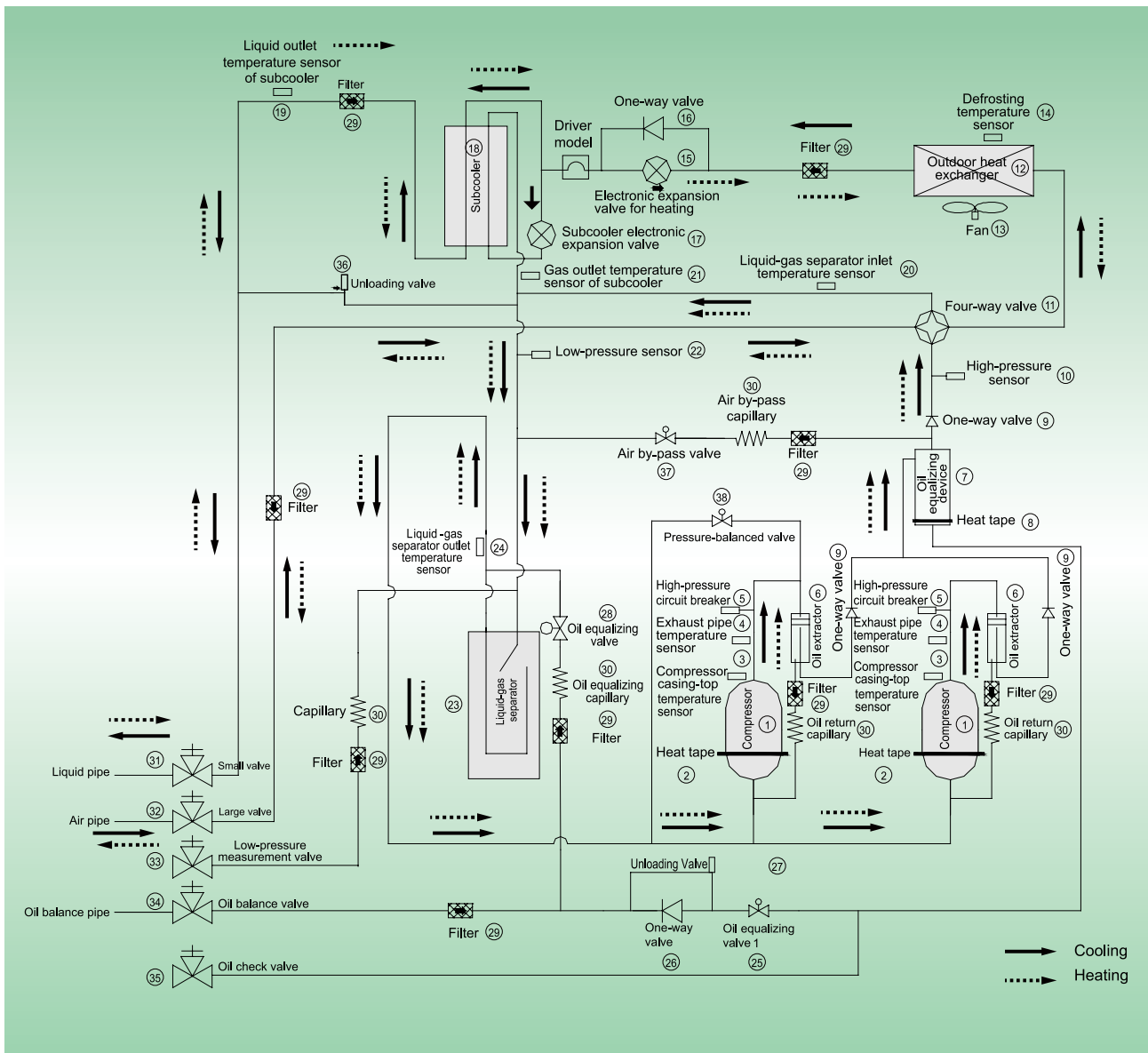

NOTICE: The pressure balance valve is configured for the two compressors modules only.

6 UNIT CAPACITY CORRECTION

6.1 Correction of Capacity Along with Ambient Temperature and Configuration Ratio

➤ Cooling Capacity Calculation Method

GMV-72WM/B-F(U), GMV-72WM/B-U(U)

TC—Total capacity of outdoor unit; PI—Power input of outdoor unit

Combination	Outdoor air temp (°FDB)	Indoor air temp													
		57.2°FWB		60.8°FWB		64.4°FWB		66.2°FWB		68°FWB		71.6°FWB		75.2°FWB	
		68°FDB		73.4°FDB		78.8°FDB		80.6°FDB		82.4°FDB		86°FDB		89.6°FDB	
		TC	PI	TC	PI	TC	PI	TC	PI	TC	PI	TC	PI	TC	PI
		kBtu/h	kW	kBtu/h	kW	kBtu/h	kW	kBtu/h	kW	kBtu/h	kW	kBtu/h	kW	kBtu/h	kW
135%	23.0	63.3	2.41	75.3	2.94	87.4	2.97	90.8	2.99	92.4	3.00	94.8	3.04	97.2	3.07
	32.0	63.3	2.42	75.3	2.94	87.4	2.98	90.8	2.99	92.4	3.01	94.8	3.04	97.2	3.08
	39.2	63.3	2.43	75.3	2.95	87.4	2.99	90.8	3.00	92.4	3.02	94.8	3.06	97.2	3.09
	44.6	63.3	2.47	75.3	3.01	87.4	3.04	90.8	3.06	92.4	3.08	94.8	3.11	97.2	3.15
	50.0	63.3	2.51	75.3	3.07	87.4	3.65	90.8	3.73	91.8	3.66	94.1	3.51	96.4	3.34
	53.6	63.3	2.56	75.3	3.13	87.4	3.73	89.5	3.71	90.8	3.64	92.8	3.48	95.2	3.43
	57.2	63.3	2.61	75.3	3.19	87.2	3.77	88.5	3.70	89.5	3.62	91.8	3.59	94.1	3.62
	60.8	63.3	2.65	75.3	3.26	86.1	3.76	87.2	3.73	88.2	3.74	90.5	3.78	92.8	3.81
	64.4	63.3	2.70	75.3	3.32	84.9	3.90	85.9	3.92	87.2	3.94	89.5	3.98	91.8	4.01
	68.0	63.3	2.76	75.3	3.54	83.6	4.09	84.9	4.11	85.9	4.13	88.2	4.17	90.5	4.21
	69.8	63.3	2.84	75.3	3.66	83.1	4.18	84.3	4.20	85.4	4.23	87.7	4.27	90.0	4.31
	73.4	63.3	3.04	75.3	3.92	82.0	4.37	83.1	4.40	84.1	4.42	86.4	4.46	88.7	4.51
	77.0	63.3	3.25	75.3	4.20	80.7	4.56	82.0	4.59	83.1	4.62	85.4	4.66	87.7	4.70
	80.6	63.3	3.47	75.3	4.50	79.7	4.02	80.7	4.78	81.8	4.81	84.1	4.86	86.4	4.91
	84.2	63.3	3.70	75.3	4.81	78.4	4.95	79.5	4.98	80.7	5.01	83.1	5.06	85.4	5.11
	87.8	63.3	3.95	75.1	5.09	77.1	5.15	78.4	5.17	79.5	5.20	81.8	5.26	84.1	5.31
	91.4	63.3	4.21	73.8	5.28	76.1	5.33	77.1	5.37	78.4	5.39	80.7	5.45	82.8	5.52
	95.0	63.3	4.49	72.5	5.47	74.8	5.53	76.1	5.56	77.1	5.59	79.5	5.66	81.8	5.72
	98.6	63.3	4.78	71.5	5.67	73.8	5.73	74.8	5.76	76.1	5.80	78.2	5.87	80.5	5.93
	102.2	63.3	5.09	70.2	5.86	72.5	5.92	73.8	5.96	74.8	6.00	77.1	6.06	79.5	6.14
105.8	59.8	5.66	68.9	6.89	71.1	6.97	72.4	6.45	73.4	6.49	75.6	6.57	77.9	6.63	
111.2	55.7	6.15	65.3	7.49	67.7	7.75	69.3	7.29	70.4	6.99	72.8	6.90	75.2	6.98	
116.6	52.5	8.19	63.1	9.97	65.5	8.14	66.8	7.40	67.9	7.44	70.3	7.41	72.8	7.49	
122.0	48.1	8.04	56.6	9.79	58.4	8.58	59.6	8.01	60.6	7.94	62.8	7.92	65.4	7.83	
125.6	36.4	6.78	42.1	8.26	43.8	7.31	44.9	7.29	46.3	7.16	50.1	7.07	53.2	6.86	

GMV5 DC Inverter VRF Units Technical Sales Guide

Combination	Outdoor air temp (°FDB)	Indoor air temp													
		57.2°FWB		60.8°FWB		64.4°FWB		66.2°FWB		68°FWB		71.6°FWB		75.2°FWB	
		68°FDB		73.4°FDB		78.8°FDB		80.6°FDB		82.4°FDB		86°FDB		89.6°FDB	
		TC	PI	TC	PI	TC	PI	TC	PI	TC	PI	TC	PI	TC	PI
		kBtu/h	kW	kBtu/h	kW	kBtu/h	kW	kBtu/h	kW	kBtu/h	kW	kBtu/h	kW	kBtu/h	kW
120%	23.0	58.4	2.15	69.4	2.78	80.7	2.95	86.4	2.97	90.9	2.98	93.0	3.02	95.0	3.05
	32.0	58.4	2.15	69.4	2.78	80.7	2.96	86.4	2.97	90.9	2.99	93.0	3.02	95.0	3.05
	39.2	58.4	2.16	69.4	2.79	80.7	2.97	86.4	2.98	90.9	3.00	93.0	3.03	95.0	3.06
	44.6	58.4	2.20	69.4	2.85	80.7	3.02	86.4	3.04	90.9	3.06	93.0	3.09	95.0	3.12
	50.0	58.4	2.29	69.4	2.80	80.7	3.33	86.4	3.60	90.5	3.76	92.6	3.61	94.6	3.47
	53.6	58.4	2.34	69.4	2.85	80.7	3.40	86.4	3.67	89.2	3.73	91.3	3.59	93.3	3.45
	57.2	58.4	2.38	69.4	2.91	80.7	3.46	86.4	3.74	87.9	3.71	90.3	3.57	92.3	3.59
	60.8	58.4	2.43	69.4	2.97	80.7	3.53	85.9	3.77	86.9	3.72	89.0	3.76	91.0	3.79
	64.4	58.4	2.47	69.4	3.03	80.7	3.65	84.6	3.90	85.6	3.91	87.7	3.95	90.0	3.98
	68.0	58.4	2.52	69.4	3.15	80.7	3.92	83.6	4.09	84.6	4.10	86.7	4.14	88.7	4.17
	69.8	58.4	2.54	69.4	3.26	80.7	4.06	82.8	4.18	83.8	4.20	86.1	4.23	88.2	4.28
	73.4	58.4	2.72	69.4	3.49	80.7	4.35	81.8	4.37	82.8	4.39	84.9	4.43	86.9	4.47
	77.0	58.4	2.90	69.4	3.73	79.5	4.54	80.5	4.56	81.5	4.58	83.8	4.62	85.9	4.67
	80.6	58.4	3.10	69.4	3.99	78.4	4.73	79.5	4.76	80.5	4.78	82.5	4.82	84.6	4.87
	84.2	58.4	3.31	69.4	4.26	77.1	4.92	78.2	4.95	79.2	4.97	81.3	5.02	83.6	5.06
	87.8	58.4	3.53	69.4	4.55	76.1	5.12	77.1	5.14	78.2	5.17	80.2	5.22	82.3	5.27
	91.4	58.4	3.76	69.4	4.86	74.8	5.31	75.9	5.34	76.9	5.36	78.9	5.42	81.0	5.47
	95.0	58.4	4.00	69.4	5.17	73.5	5.50	74.6	5.53	75.9	5.56	77.9	5.62	80.0	5.67
	98.6	58.4	4.26	69.4	5.51	72.5	5.70	73.5	5.73	74.6	5.76	76.6	5.81	78.7	5.88
	102.2	58.4	4.53	69.2	5.82	71.2	5.89	72.3	5.92	73.3	5.95	75.6	6.02	77.7	6.08
105.8	55.2	5.04	66.0	6.52	69.9	6.93	70.9	6.41	72.1	6.45	74.2	6.51	76.2	6.58	
111.2	51.4	5.48	62.5	7.09	66.6	7.70	67.9	7.24	69.3	6.95	71.4	6.85	73.6	6.92	
116.6	48.5	7.29	60.4	9.43	64.4	8.08	65.5	7.35	66.8	7.39	69.0	7.36	71.2	7.43	
122.0	44.4	7.16	54.2	9.26	57.4	8.52	58.4	7.96	59.6	7.89	61.6	7.86	64.0	7.77	
125.6	33.6	6.04	40.3	7.81	43.0	7.26	44.0	7.24	45.5	7.11	49.1	7.02	52.0	6.81	
110%	23.0	53.5	1.90	63.8	2.44	74.1	2.93	79.2	2.95	84.3	2.96	90.9	2.99	92.8	3.02
	32.0	53.5	1.90	63.8	2.45	74.1	2.94	79.2	2.95	84.3	2.97	90.9	3.00	92.8	3.03
	39.2	53.5	1.91	63.8	2.46	74.1	2.95	79.2	2.96	84.3	2.98	90.9	3.01	92.8	3.04
	44.6	53.5	1.94	63.8	2.50	74.1	3.00	79.2	3.02	84.3	3.04	90.9	3.06	92.8	3.09
	50.0	53.5	2.08	63.8	2.54	74.1	3.01	79.2	3.26	84.3	3.51	90.8	3.72	92.8	3.59
	53.6	53.5	2.12	63.8	2.59	74.1	3.07	79.2	3.32	84.3	3.57	89.7	3.70	91.5	3.57
	57.2	53.5	2.16	63.8	2.63	74.1	3.13	79.2	3.38	84.3	3.64	88.5	3.70	90.5	3.56
	60.8	53.5	2.20	63.8	2.68	74.1	3.19	79.2	3.45	84.3	3.71	87.4	3.73	89.2	3.76
	64.4	53.5	2.24	63.8	2.73	74.1	3.26	79.2	3.54	84.3	3.89	86.1	3.92	88.2	3.95
	68.0	53.5	2.29	63.8	2.79	74.1	3.45	79.2	3.81	83.1	4.08	85.1	4.11	86.9	4.15
	69.8	53.5	2.31	63.8	2.87	74.1	3.57	79.2	3.95	82.5	4.17	84.3	4.20	86.4	4.24
	73.4	53.5	2.42	63.8	3.08	74.1	3.83	79.2	4.23	81.3	4.36	83.3	4.40	85.1	4.44
	77.0	53.5	2.57	63.8	3.29	74.1	4.09	79.2	4.53	80.2	4.55	82.0	4.59	84.1	4.63
	80.6	53.5	2.75	63.8	3.52	74.1	4.38	77.9	4.73	78.9	4.74	81.0	4.78	82.8	4.83
	84.2	53.5	2.93	63.8	3.76	74.1	4.68	76.9	4.92	77.9	4.94	79.7	4.98	81.8	5.03
	87.8	53.5	3.12	63.8	4.01	74.1	5.00	75.6	5.11	76.6	5.13	78.7	5.17	80.5	5.23
	91.4	53.5	3.32	63.8	4.27	73.5	5.27	74.6	5.30	75.6	5.32	77.4	5.37	79.5	5.42
	95.0	53.5	3.54	63.8	4.55	72.5	5.46	73.3	5.49	74.3	5.52	76.1	5.57	78.2	5.62
	98.6	53.5	3.76	63.8	4.84	71.2	5.66	72.3	5.68	73.0	5.71	75.1	5.77	76.9	5.82
	102.2	53.5	4.00	63.8	5.16	69.9	5.85	71.0	5.88	72.0	5.91	73.8	5.97	75.9	6.03
105.8	50.5	4.45	60.6	5.73	68.9	6.88	69.7	6.37	70.7	6.40	72.5	6.46	74.5	6.52	
111.2	47.1	4.84	57.4	6.23	65.6	7.65	66.7	7.19	67.9	6.90	69.7	6.80	71.9	6.86	
116.6	44.4	6.44	55.5	8.29	63.5	8.03	64.3	7.30	65.4	7.34	67.4	7.30	69.6	7.37	
122.0	40.7	6.33	49.7	8.14	56.6	8.46	57.4	7.91	58.3	7.84	60.1	7.80	62.5	7.70	
125.6	30.8	5.34	37.0	6.87	42.4	7.21	43.2	7.19	44.6	7.07	48.0	6.96	50.8	6.75	

Combination	Outdoor air temp (°FDB)	Indoor air temp													
		57.2°FWB		60.8°FWB		64.4°FWB		66.2°FWB		68°FWB		71.6°FWB		75.2°FWB	
		68°FDB		73.4°FDB		78.8°FDB		80.6°FDB		82.4°FDB		86°FDB		89.6°FDB	
		TC	PI	TC	PI	TC	PI	TC	PI	TC	PI	TC	PI	TC	PI
		kBtu/h	kW	kBtu/h	kW	kBtu/h	kW	kBtu/h	kW	kBtu/h	kW	kBtu/h	kW	kBtu/h	kW
100%	23.0	48.6	1.66	57.9	2.13	67.4	2.65	72.0	2.93	76.6	2.94	86.2	2.97	91.0	3.00
	32.0	48.6	1.66	57.9	2.13	67.4	2.66	72.0	2.93	76.6	2.95	86.2	2.98	91.0	3.00
	39.2	48.6	1.67	57.9	2.14	67.4	2.67	72.0	2.94	76.6	2.96	86.2	2.99	91.0	3.01
	44.6	48.6	1.70	57.9	2.18	67.4	2.71	72.0	3.00	76.6	3.01	86.2	3.04	91.0	3.07
	50.0	48.6	1.88	57.9	2.29	67.4	2.70	72.0	2.92	76.6	3.15	86.1	3.57	91.0	3.71
	53.6	48.6	1.91	57.9	2.32	67.4	2.74	72.0	2.96	76.6	3.21	86.1	3.63	89.7	3.68
	57.2	48.6	1.94	57.9	2.36	67.4	2.79	72.0	3.01	76.6	3.27	86.1	3.69	88.7	3.65
	60.8	48.6	1.98	57.9	2.41	67.4	2.85	72.0	3.08	76.6	3.35	85.8	3.78	87.4	3.73
	64.4	48.6	2.03	57.9	2.46	67.4	2.90	72.0	3.14	76.6	3.41	84.6	3.85	86.4	3.91
	68.0	48.6	2.06	57.9	2.50	67.4	3.00	72.0	3.30	76.6	3.63	83.3	4.05	85.1	4.11
	69.8	48.6	2.08	57.9	2.53	67.4	3.10	72.0	3.42	76.6	3.75	82.8	4.19	84.6	4.23
	73.4	48.6	2.13	57.9	2.70	67.4	3.34	72.0	3.67	76.6	4.03	81.8	4.43	83.3	4.47
	77.0	48.6	2.27	57.9	2.87	67.4	3.55	72.0	3.91	76.6	4.32	80.5	4.59	82.3	4.64
	80.6	48.6	2.42	57.9	3.07	67.4	3.81	72.0	4.19	76.6	4.63	79.2	4.76	81.0	4.80
	84.2	48.6	2.57	57.9	3.28	67.4	4.07	72.0	4.49	76.4	4.90	78.1	4.99	79.9	5.03
	87.8	48.6	2.73	57.9	3.49	67.4	4.34	72.0	4.83	75.4	5.10	76.3	5.19	78.7	5.23
	91.4	48.6	2.91	57.9	3.72	67.4	4.63	72.0	5.12	74.1	5.29	76.0	5.34	77.6	5.38
	95.0	48.6	3.09	57.9	3.96	67.4	4.94	72.0	5.45	72.8	5.48	74.5	5.53	76.3	5.58
	98.6	48.6	3.29	57.9	4.22	67.4	5.26	70.7	5.65	71.9	5.68	73.4	5.72	75.2	5.77
	102.2	48.6	3.51	57.9	4.49	67.4	5.60	69.8	5.84	70.1	5.87	72.5	5.91	73.4	5.96
105.8	45.9	3.90	55.0	4.99	64.0	6.22	68.4	6.33	69.2	6.36	70.9	6.42	72.7	6.47	
111.2	42.8	4.24	52.1	5.42	61.0	6.91	65.5	7.14	66.4	6.85	68.3	6.75	70.2	6.81	
116.6	40.3	5.64	50.3	7.22	59.0	7.26	63.2	7.25	64.0	7.29	66.0	7.24	67.9	7.31	
122.0	36.9	5.53	45.1	7.09	52.6	7.65	56.4	7.85	57.1	7.78	58.9	7.74	61.1	7.64	
125.6	28.0	4.67	33.6	5.98	39.4	6.51	42.5	7.14	43.7	7.02	47.0	6.91	49.6	6.70	
90%	23.0	43.7	1.45	52.1	1.83	60.6	2.26	64.8	2.50	68.9	2.75	77.4	2.94	85.9	2.97
	32.0	43.7	1.45	52.1	1.84	60.6	2.27	64.8	2.51	68.9	2.76	77.4	2.95	85.9	2.98
	39.2	43.7	1.46	52.1	1.84	60.6	2.28	64.8	2.52	68.9	2.77	77.4	2.96	85.9	2.99
	44.6	43.7	1.48	52.1	1.88	60.6	2.32	64.8	2.56	68.9	2.82	77.4	3.02	85.9	3.04
	50.0	43.7	1.64	52.1	1.97	60.6	2.31	64.8	2.60	69.0	2.77	77.5	3.17	85.9	3.60
	53.6	43.7	1.66	52.1	2.00	60.6	2.34	64.8	2.64	69.0	2.82	77.5	3.23	85.9	3.64
	57.2	43.7	1.69	52.1	2.03	60.6	2.38	64.8	2.68	69.0	2.87	77.5	3.28	85.9	3.70
	60.8	43.7	1.73	52.1	2.08	60.6	2.43	64.8	2.74	69.0	2.94	77.5	3.36	85.6	3.77
	64.4	43.7	1.77	52.1	2.12	60.6	2.48	64.8	2.79	69.0	2.99	77.5	3.44	84.8	3.91
	68.0	43.7	1.80	52.1	2.16	60.6	2.56	64.8	2.85	69.0	3.12	77.5	3.69	83.3	4.07
	69.8	43.7	1.81	52.1	2.18	60.6	2.65	64.8	2.94	69.0	3.22	77.5	3.82	82.8	4.16
	73.4	43.7	1.86	52.1	2.33	60.6	2.85	64.8	3.16	69.0	3.45	77.5	4.10	81.5	4.38
	77.0	43.7	1.98	52.1	2.48	60.6	3.03	64.8	3.37	69.0	3.69	77.5	4.39	80.5	4.56
	80.6	43.7	2.11	52.1	2.65	60.6	3.25	64.8	3.60	69.0	3.95	77.5	4.68	79.2	4.76
	84.2	43.7	2.24	52.1	2.83	60.6	3.48	64.8	3.85	69.0	4.22	76.6	4.91	78.2	4.95
	87.8	43.7	2.38	52.1	3.01	60.6	3.71	64.8	4.11	69.0	4.50	75.3	5.08	76.9	5.15
	91.4	43.7	2.54	52.1	3.21	60.6	3.95	64.8	4.37	69.0	4.79	74.3	5.29	75.9	5.34
	95.0	43.7	2.70	52.1	3.41	60.6	4.22	64.8	4.66	69.0	5.12	73.0	5.48	74.6	5.53
	98.6	43.7	2.87	52.1	3.64	60.6	4.49	63.6	4.83	69.0	5.48	71.7	5.68	73.5	5.66
	102.2	43.7	3.06	52.1	3.87	60.6	4.78	62.8	4.98	69.0	5.81	70.7	5.89	72.3	5.87
105.8	41.3	3.40	49.5	4.30	57.6	5.31	61.6	5.40	65.6	5.94	69.5	6.36	71.1	6.42	
111.2	38.5	3.70	46.9	4.68	54.9	5.90	59.0	6.10	63.0	6.40	66.9	6.69	68.6	6.75	
116.6	36.3	4.92	45.3	6.22	53.1	6.20	56.9	6.19	60.7	6.81	64.6	7.18	66.4	7.25	
122.0	33.2	4.83	40.6	6.11	47.4	6.53	50.7	6.71	54.1	7.27	57.7	7.67	59.7	7.58	
125.6	25.2	4.07	30.2	5.16	35.5	5.56	38.2	6.10	41.4	6.56	46.0	6.85	48.5	6.64	

GMV5 DC Inverter VRF Units Technical Sales Guide

Combination	Outdoor air temp (°FDB)	Indoor air temp													
		57.2°FWB		60.8°FWB		64.4°FWB		66.2°FWB		68°FWB		71.6°FWB		75.2°FWB	
		68°FDB		73.4°FDB		78.8°FDB		80.6°FDB		82.4°FDB		86°FDB		89.6°FDB	
		TC	PI	TC	PI	TC	PI	TC	PI	TC	PI	TC	PI	TC	PI
	kBtu/h	kW	kBtu/h	kW	kBtu/h	kW	kBtu/h	kW	kBtu/h	kW	kBtu/h	kW	kBtu/h	kW	
80%	23.0	38.9	1.25	46.3	1.54	53.9	1.92	57.6	2.11	61.2	2.31	68.9	2.74	76.4	2.94
	32.0	38.9	1.25	46.3	1.55	53.9	1.92	57.6	2.12	61.2	2.31	68.9	2.74	76.4	2.94
	39.2	38.9	1.26	46.3	1.55	53.9	1.93	57.6	2.12	61.2	2.32	68.9	2.75	76.4	2.95
	44.6	38.9	1.28	46.3	1.58	53.9	1.96	57.6	2.16	61.2	2.36	68.9	2.81	76.4	3.01
	50.0	38.9	1.49	46.3	1.79	53.9	2.10	57.6	2.26	61.3	2.42	68.9	2.77	76.4	3.22
	53.6	38.9	1.51	46.3	1.82	53.9	2.14	57.6	2.31	61.3	2.47	68.9	2.82	76.4	3.19
	57.2	38.9	1.54	46.3	1.85	53.9	2.18	57.6	2.34	61.3	2.52	68.9	2.87	76.4	3.26
	60.8	38.9	1.57	46.3	1.88	53.9	2.22	57.6	2.39	61.3	2.55	68.9	2.93	76.4	3.38
	64.4	38.9	1.59	46.3	1.92	53.9	2.27	57.6	2.44	61.3	2.60	68.9	3.00	76.4	3.62
	68.0	38.9	1.62	46.3	1.96	53.9	2.31	57.6	2.48	61.3	2.66	68.9	3.11	76.4	3.75
	69.8	38.9	1.64	46.3	1.97	53.9	2.33	57.6	2.51	61.3	2.72	68.9	3.22	76.4	4.01
	73.4	38.9	1.67	46.3	2.01	53.9	2.44	57.6	2.68	61.3	2.91	68.9	3.44	76.4	4.29
	77.0	38.9	1.72	46.3	2.14	53.9	2.61	57.6	2.86	61.3	3.11	68.9	3.68	76.4	4.58
	80.6	38.9	1.83	46.3	2.28	53.9	2.78	57.6	3.05	61.3	3.33	68.9	3.93	76.4	4.74
	84.2	38.9	1.95	46.3	2.43	53.9	2.96	57.6	3.25	61.1	3.55	68.9	4.20	76.4	4.91
	87.8	38.9	2.07	46.3	2.58	53.9	3.15	57.6	3.46	61.1	3.79	68.9	4.48	75.1	5.09
	91.4	38.9	2.20	46.3	2.87	53.9	3.36	57.6	3.69	61.1	4.04	68.9	4.78	74.1	5.27
	95.0	38.9	2.33	46.3	2.87	53.9	3.57	57.6	3.93	61.1	4.30	68.9	5.10	72.8	5.47
	98.6	38.9	2.47	46.3	3.09	53.9	3.80	56.6	4.19	61.1	4.58	68.9	5.43	71.7	5.67
	102.2	38.9	2.62	46.3	3.29	53.9	4.04	55.8	4.46	61.1	4.87	68.9	5.79	70.5	5.88
105.8	36.7	2.94	44.0	3.62	51.2	4.50	54.8	4.56	58.1	4.99	65.6	5.92	69.4	6.34	
111.2	34.2	3.19	41.7	3.94	48.8	5.00	52.4	5.15	55.8	5.37	63.1	6.22	67.0	6.67	
116.6	32.3	4.25	40.3	5.24	47.2	5.25	50.6	5.23	53.8	5.72	61.0	6.68	64.8	7.16	
122.0	29.6	4.17	36.1	5.14	42.1	5.54	45.1	5.66	48.0	6.10	54.4	7.14	58.2	7.49	
125.6	22.4	3.52	26.8	4.34	31.5	4.72	34.0	5.15	36.7	5.50	43.4	6.38	47.3	6.56	
70%	23.0	34.0	1.07	40.5	1.32	47.2	1.60	50.4	1.75	53.7	1.91	60.2	2.25	66.9	2.62
	32.0	34.0	1.07	40.5	1.32	47.2	1.60	50.4	1.76	53.7	1.91	60.2	2.25	66.9	2.62
	39.2	34.0	1.07	40.5	1.33	47.2	1.61	50.4	1.76	53.7	1.92	60.2	2.26	66.9	2.63
	44.6	34.0	1.09	40.5	1.35	47.2	1.64	50.4	1.79	53.7	1.96	60.2	2.30	66.9	2.68
	50.0	34.0	1.32	40.5	1.56	47.2	1.82	50.4	1.96	53.6	2.09	60.3	2.38	66.9	2.68
	53.6	34.0	1.33	40.5	1.58	47.2	1.85	50.4	1.99	53.6	2.13	60.3	2.43	66.9	2.73
	57.2	34.0	1.35	40.5	1.61	47.2	1.88	50.4	2.02	53.6	2.17	60.3	2.47	66.9	2.78
	60.8	34.0	1.37	40.5	1.64	47.2	1.92	50.4	2.07	53.6	2.21	60.3	2.51	66.9	2.83
	64.4	34.0	1.40	40.5	1.67	47.2	1.96	50.4	2.10	53.6	2.25	60.3	2.57	66.9	2.89
	68.0	34.0	1.42	40.5	1.70	47.2	1.99	50.4	2.14	53.6	2.29	60.3	2.62	66.9	2.97
	69.8	34.0	1.43	40.5	1.71	47.2	2.01	50.4	2.16	53.6	2.32	60.3	2.65	66.9	3.07
	73.4	34.0	1.46	40.5	1.74	47.2	2.05	50.4	2.23	53.6	2.43	60.3	2.84	66.9	3.29
	77.0	34.0	1.48	40.5	1.82	47.2	2.18	50.4	2.39	53.6	2.59	60.3	3.04	66.9	3.52
	80.6	34.0	1.57	40.5	1.93	47.2	2.33	50.4	2.54	53.6	2.77	60.3	3.25	66.9	3.76
	84.2	34.0	1.67	40.5	2.05	47.2	2.48	50.4	2.71	53.6	2.95	60.3	3.46	66.9	4.02
	87.8	34.0	1.76	40.5	2.18	47.2	2.64	50.4	2.88	53.6	3.14	60.3	3.69	66.9	4.29
	91.4	34.0	1.87	40.5	2.32	47.2	2.81	50.4	3.06	53.6	3.34	60.3	3.93	66.9	4.57
	95.0	34.0	1.98	40.5	2.45	47.2	2.98	50.4	3.26	53.6	3.56	60.3	4.19	66.9	4.87
	98.6	34.0	2.09	40.5	2.60	47.2	3.17	49.5	3.47	53.6	3.79	60.3	4.46	66.9	5.19
	102.2	34.0	2.22	40.5	2.76	47.2	3.36	48.8	3.68	53.6	4.02	60.3	4.74	66.9	5.53
105.8	32.2	2.50	38.5	3.09	44.8	3.75	47.9	3.79	51.0	4.13	57.4	4.86	63.7	5.65	
111.2	29.9	2.72	36.5	3.36	42.7	4.17	45.9	4.28	49.0	4.45	55.2	5.11	61.5	5.95	
116.6	28.2	3.62	35.2	4.48	41.3	4.38	44.3	4.34	47.2	4.73	53.4	5.49	59.5	6.38	
122.0	25.9	3.55	31.6	4.39	36.8	4.61	39.5	4.70	42.1	5.05	47.6	5.87	53.5	6.68	
125.6	19.6	3.00	23.5	3.71	27.6	3.93	29.7	4.28	32.2	4.55	38.0	5.24	43.5	5.85	

Combination	Outdoor air temp (°FDB)	Indoor air temp													
		57.2°FWB		60.8°FWB		64.4°FWB		66.2°FWB		68°FWB		71.6°FWB		75.2°FWB	
		68°FDB		73.4°FDB		78.8°FDB		80.6°FDB		82.4°FDB		86°FDB		89.6°FDB	
		TC	PI	TC	PI	TC	PI	TC	PI	TC	PI	TC	PI	TC	PI
		kBtu/h	kW	kBtu/h	kW	kBtu/h	kW	kBtu/h	kW	kBtu/h	kW	kBtu/h	kW	kBtu/h	kW
60%	23.0	29.2	0.90	34.7	1.09	40.4	1.31	43.2	1.43	46.0	1.55	51.7	1.81	57.3	2.09
	32.0	29.2	0.90	34.7	1.10	40.4	1.31	43.2	1.43	46.0	1.55	51.7	1.82	57.3	2.10
	39.2	29.2	0.90	34.7	1.10	40.4	1.32	43.2	1.44	46.0	1.56	51.7	1.82	57.3	2.10
	44.6	29.2	0.92	34.7	1.12	40.4	1.34	43.2	1.46	46.0	1.59	51.7	1.86	57.3	2.14
	50.0	29.2	1.14	34.7	1.34	40.4	1.55	43.2	1.66	46.0	1.77	51.7	2.01	57.3	2.25
	53.6	29.2	1.16	34.7	1.36	40.4	1.58	43.2	1.69	46.0	1.80	51.7	2.04	57.3	2.29
	57.2	29.2	1.18	34.7	1.38	40.4	1.60	43.2	1.72	46.0	1.84	51.7	2.08	57.3	2.33
	60.8	29.2	1.19	34.7	1.40	40.4	1.63	43.2	1.75	46.0	1.87	51.7	2.12	57.3	2.37
	64.4	29.2	1.21	34.7	1.43	40.4	1.66	43.2	1.78	46.0	1.90	51.7	2.15	57.3	2.42
	68.0	29.2	1.23	34.7	1.46	40.4	1.69	43.2	1.82	46.0	1.94	51.7	2.20	57.3	2.47
	69.8	29.2	1.24	34.7	1.46	40.4	1.71	43.2	1.83	46.0	1.96	51.7	2.22	57.3	2.49
	73.4	29.2	1.26	34.7	1.49	40.4	1.73	43.2	1.87	46.0	1.99	51.7	2.31	57.3	2.65
	77.0	29.2	1.28	34.7	1.52	40.4	1.80	43.2	1.96	46.0	2.12	51.7	2.46	57.3	2.83
	80.6	29.2	1.33	34.7	1.61	40.4	1.92	43.2	2.09	46.0	2.26	51.7	2.62	57.3	3.02
	84.2	29.2	1.40	34.7	1.71	40.4	2.04	43.2	2.22	46.0	2.40	51.7	2.80	57.3	3.23
	87.8	29.2	1.49	34.7	1.82	40.4	2.17	43.2	2.36	46.0	2.56	51.7	2.98	57.3	3.43
	91.4	29.2	1.57	34.7	1.92	40.4	2.30	43.2	2.51	46.0	2.72	51.7	3.17	57.3	3.66
	95.0	29.2	1.67	34.7	2.04	40.4	2.44	43.2	2.66	46.0	2.89	51.7	3.37	57.3	3.90
	98.6	29.2	1.76	34.7	2.15	40.4	2.59	42.4	2.82	46.0	3.06	51.7	3.59	57.3	4.15
	102.2	29.2	1.86	34.7	2.28	40.4	2.74	41.9	2.99	46.0	3.26	51.7	3.81	57.3	4.41
105.8	27.6	2.10	33.0	2.57	38.4	3.07	41.1	3.09	43.7	3.35	49.2	3.91	54.7	4.52	
111.2	25.7	2.29	31.2	2.79	36.6	3.42	39.3	3.49	42.0	3.61	47.3	4.12	52.8	4.75	
116.6	24.2	3.04	30.2	3.71	35.4	3.59	37.9	3.54	40.5	3.84	45.7	4.42	51.0	5.10	
122.0	22.2	2.99	27.1	3.64	31.6	3.78	33.8	3.83	36.1	4.10	40.8	4.72	45.9	5.34	
125.6	16.8	2.52	20.1	3.07	23.6	3.22	25.5	3.49	27.6	3.70	32.6	4.22	37.3	4.67	
50%	23.0	24.3	0.74	28.9	0.89	33.7	1.05	36.0	1.14	38.3	1.23	43.1	1.42	47.8	1.63
	32.0	24.3	0.74	28.9	0.89	33.7	1.05	36.0	1.14	38.3	1.23	43.1	1.42	47.8	1.63
	39.2	24.3	0.75	28.9	0.89	33.7	1.06	36.0	1.14	38.3	1.23	43.1	1.43	47.8	1.64
	44.6	24.3	0.76	28.9	0.91	33.7	1.08	36.0	1.16	38.3	1.26	43.1	1.46	47.8	1.67
	50.0	24.3	0.98	28.9	1.14	33.7	1.30	36.0	1.39	38.3	1.47	43.1	1.65	47.8	1.84
	53.6	24.3	0.99	28.9	1.15	33.7	1.32	36.0	1.40	38.3	1.50	43.1	1.68	47.8	1.87
	57.2	24.3	1.01	28.9	1.17	33.7	1.34	36.0	1.43	38.3	1.52	43.1	1.71	47.8	1.91
	60.8	24.3	1.02	28.9	1.18	33.7	1.36	36.0	1.46	38.3	1.54	43.1	1.74	47.8	1.94
	64.4	24.3	1.04	28.9	1.21	33.7	1.38	36.0	1.48	38.3	1.57	43.1	1.77	47.8	1.98
	68.0	24.3	1.05	28.9	1.22	33.7	1.40	36.0	1.51	38.3	1.60	43.1	1.81	47.8	2.01
	69.8	24.3	1.06	28.9	1.23	33.7	1.42	36.0	1.51	38.3	1.62	43.1	1.82	47.8	2.04
	73.4	24.3	1.07	28.9	1.25	33.7	1.44	36.0	1.54	38.3	1.65	43.1	1.85	47.8	2.08
	77.0	24.3	1.09	28.9	1.27	33.7	1.47	36.0	1.57	38.3	1.70	43.1	1.95	47.8	2.22
	80.6	24.3	1.11	28.9	1.32	33.7	1.55	36.0	1.68	38.3	1.80	43.1	2.07	47.8	2.37
	84.2	24.3	1.17	28.9	1.40	33.7	1.65	36.0	1.78	38.2	1.92	43.1	2.21	47.8	2.52
	87.8	24.3	1.23	28.9	1.48	33.7	1.76	36.0	1.89	38.2	2.04	43.1	2.34	47.8	2.68
	91.4	24.3	1.31	28.9	1.57	33.7	1.85	36.0	2.00	38.2	2.16	43.1	2.49	47.8	2.85
	95.0	24.3	1.38	28.9	1.65	33.7	1.96	36.0	2.12	38.2	2.29	43.1	2.65	47.8	3.03
	98.6	24.3	1.46	28.9	1.75	33.7	2.07	35.4	2.24	38.2	2.43	43.1	2.81	47.8	3.22
	102.2	24.3	1.54	28.9	1.84	33.7	2.19	34.9	2.37	38.2	2.57	43.1	2.98	47.8	3.42
105.8	23.0	1.74	27.5	2.08	32.0	2.46	34.2	2.46	36.3	2.65	41.0	3.07	45.6	3.51	
111.2	21.4	1.89	26.0	2.27	30.5	2.74	32.8	2.77	34.9	2.86	39.4	3.23	44.0	3.69	
116.6	20.2	2.52	25.2	3.01	29.5	2.87	31.6	2.82	33.6	3.04	38.1	3.47	42.6	3.97	
122.0	18.5	2.47	22.6	2.96	26.3	3.03	28.2	3.05	30.0	3.25	34.0	3.70	38.3	4.15	
125.6	14.0	2.09	16.8	2.50	19.7	2.58	21.2	2.77	22.9	2.93	27.1	3.31	31.1	3.63	

GMV5 DC Inverter VRF Units Technical Sales Guide

GMV-96WM/B-F(U), GMV-96WM/B-U(U)

TC—Total capacity of outdoor unit; PI—Power input of outdoor unit

Combination	Outdoor air temp (°FDB)	Indoor air temp													
		57.2°FWB		60.8°FWB		64.4°FWB		66.2°FWB		68°FWB		71.6°FWB		75.2°FWB	
		68°FDB		73.4°FDB		78.8°FDB		80.6°FDB		82.4°FDB		86°FDB		89.6°FDB	
		TC	PI	TC	PI	TC	PI	TC	PI	TC	PI	TC	PI	TC	PI
		kBtu/h	kW	kBtu/h	kW	kBtu/h	kW	kBtu/h	kW	kBtu/h	kW	kBtu/h	kW	kBtu/h	kW
135%	23.0	84.3	3.23	100.5	3.93	116.6	3.98	121.0	4.00	123.2	4.02	126.4	4.07	129.5	4.11
	32.0	84.3	3.23	100.5	3.94	116.6	3.99	121.0	4.01	123.2	4.03	126.4	4.08	129.5	4.12
	39.2	84.3	3.25	100.5	3.95	116.6	4.00	121.0	4.02	123.2	4.04	126.4	4.09	129.5	4.13
	44.6	84.3	3.31	100.5	4.03	116.6	4.07	121.0	4.10	123.2	4.12	126.4	4.17	129.5	4.21
	50.0	84.3	3.36	100.5	4.11	116.6	4.89	121.0	5.00	122.4	4.90	125.5	4.69	128.6	4.48
	53.6	84.3	3.42	100.5	4.19	116.6	4.99	119.3	4.97	121.0	4.87	123.8	4.65	126.9	4.58
	57.2	84.3	3.49	100.5	4.27	116.2	5.05	117.9	4.95	119.3	4.84	122.4	4.80	125.5	4.85
	60.8	84.3	3.55	100.5	4.36	114.9	5.03	116.2	4.99	117.6	5.01	120.7	5.06	123.8	5.11
	64.4	84.3	3.62	100.5	4.45	113.1	5.21	114.5	5.24	116.2	5.27	119.3	5.32	122.4	5.37
	68.0	84.3	3.70	100.5	4.73	111.4	5.47	113.1	5.50	114.5	5.53	117.6	5.58	120.7	5.64
	69.8	84.3	3.80	100.5	4.90	110.7	5.60	112.5	5.63	113.8	5.66	116.9	5.72	120.0	5.77
	73.4	84.3	4.07	100.5	5.25	109.4	5.85	110.7	5.88	112.1	5.91	115.2	5.97	118.3	6.03
	77.0	84.3	4.35	100.5	5.63	107.7	6.11	109.4	6.14	110.7	6.18	113.8	6.24	116.9	6.30
	80.6	84.3	4.64	100.5	6.02	106.3	5.38	107.7	6.41	109.0	6.43	112.1	6.50	115.2	6.57
	84.2	84.3	4.96	100.5	6.43	104.6	6.62	105.9	6.66	107.7	6.70	110.7	6.77	113.8	6.84
	87.8	84.3	5.29	100.1	6.81	102.9	6.89	104.6	6.93	105.9	6.96	109.0	7.03	112.1	7.11
	91.4	84.3	5.64	98.4	7.06	101.5	7.13	102.9	7.18	104.6	7.22	107.7	7.30	110.4	7.39
	95.0	84.3	6.01	96.7	7.32	99.8	7.41	101.5	7.45	102.9	7.49	105.9	7.58	109.0	7.65
	98.6	84.3	6.40	95.3	7.59	98.4	7.67	99.8	7.71	101.5	7.76	104.2	7.85	107.3	7.94
	102.2	84.3	6.81	93.6	7.84	96.7	7.93	98.4	7.98	99.8	8.03	102.9	8.12	105.9	8.22
105.8	79.7	7.57	91.9	9.22	94.8	9.34	96.5	8.64	97.8	8.69	100.9	8.79	103.9	8.88	
111.2	74.2	8.24	87.0	10.03	90.3	10.37	92.4	9.76	93.9	9.36	97.0	9.24	100.3	9.34	
116.6	70.0	10.96	84.1	13.34	87.3	10.89	89.1	9.91	90.5	9.96	93.8	9.92	97.0	10.03	
122.0	64.1	10.76	75.4	13.10	77.9	11.48	79.5	10.73	80.7	10.63	83.7	10.61	87.2	10.49	
125.6	48.6	9.08	56.1	11.05	58.4	9.78	59.9	9.76	61.7	9.58	66.7	9.47	70.9	9.19	
120%	23.0	77.8	2.87	92.6	3.72	107.7	3.95	115.2	3.97	121.2	3.99	123.9	4.04	126.7	4.08
	32.0	77.8	2.88	92.6	3.73	107.7	3.96	115.2	3.98	121.2	4.00	123.9	4.04	126.7	4.09
	39.2	77.8	2.89	92.6	3.74	107.7	3.97	115.2	4.00	121.2	4.02	123.9	4.06	126.7	4.10
	44.6	77.8	2.94	92.6	3.81	107.7	4.05	115.2	4.07	121.2	4.09	123.9	4.13	126.7	4.18
	50.0	77.8	3.07	92.6	3.75	107.7	4.46	115.2	4.82	120.7	5.03	123.4	4.83	126.2	4.64
	53.6	77.8	3.13	92.6	3.82	107.7	4.55	115.2	4.91	119.0	5.00	121.7	4.81	124.5	4.61
	57.2	77.8	3.19	92.6	3.90	107.7	4.63	115.2	5.01	117.3	4.97	120.3	4.78	123.1	4.81
	60.8	77.8	3.25	92.6	3.97	107.7	4.72	114.5	5.05	115.9	4.98	118.6	5.03	121.4	5.07
	64.4	77.8	3.31	92.6	4.05	107.7	4.89	112.8	5.21	114.2	5.23	116.9	5.28	120.0	5.33
	68.0	77.8	3.37	92.6	4.21	107.7	5.25	111.4	5.47	112.8	5.49	115.5	5.54	118.3	5.59
	69.8	77.8	3.40	92.6	4.36	107.7	5.44	110.4	5.60	111.8	5.62	114.9	5.67	117.6	5.73
	73.4	77.8	3.64	92.6	4.67	107.7	5.82	109.0	5.84	110.4	5.87	113.1	5.93	115.9	5.98
	77.0	77.8	3.89	92.6	5.00	105.9	6.08	107.3	6.10	108.7	6.13	111.8	6.19	114.5	6.25
	80.6	77.8	4.15	92.6	5.34	104.6	6.33	105.9	6.37	107.3	6.40	110.1	6.45	112.8	6.51
	84.2	77.8	4.43	92.6	5.71	102.9	6.58	104.2	6.62	105.6	6.65	108.3	6.72	111.4	6.78
	87.8	77.8	4.72	92.6	6.09	101.5	6.85	102.9	6.88	104.2	6.92	107.0	6.99	109.7	7.05
	91.4	77.8	5.03	92.6	6.50	99.8	7.10	101.1	7.14	102.5	7.17	105.3	7.25	108.0	7.32
	95.0	77.8	5.35	92.6	6.93	98.1	7.36	99.4	7.40	101.1	7.44	103.9	7.52	106.6	7.60
	98.6	77.8	5.70	92.6	7.38	96.7	7.63	98.1	7.66	99.4	7.70	102.2	7.78	104.9	7.87
	102.2	77.8	6.06	92.2	7.79	95.0	7.88	96.3	7.93	97.7	7.97	100.8	8.06	103.5	8.14
105.8	73.6	6.74	87.9	8.73	93.2	9.27	94.5	8.58	96.2	8.63	98.9	8.72	101.6	8.81	
111.2	68.5	7.33	83.3	9.49	88.7	10.30	90.5	9.69	92.3	9.30	95.2	9.17	98.1	9.27	
116.6	64.6	9.76	80.5	12.63	85.8	10.82	87.3	9.84	89.0	9.89	91.9	9.85	94.9	9.95	
122.0	59.2	9.58	72.2	12.40	76.6	11.41	77.9	10.65	79.4	10.56	82.1	10.52	85.3	10.41	
125.6	44.8	8.08	53.7	10.46	57.4	9.71	58.7	9.69	60.7	9.52	65.5	9.40	69.3	9.11	

Combination	Outdoor air temp (°FDB)	Indoor air temp													
		57.2°FWB		60.8°FWB		64.4°FWB		66.2°FWB		68°FWB		71.6°FWB		75.2°FWB	
		68°FDB		73.4°FDB		78.8°FDB		80.6°FDB		82.4°FDB		86°FDB		89.6°FDB	
		TC	PI	TC	PI	TC	PI	TC	PI	TC	PI	TC	PI	TC	PI
		kBtu/h	kW	kBtu/h	kW	kBtu/h	kW	kBtu/h	kW	kBtu/h	kW	kBtu/h	kW	kBtu/h	kW
110%	23.0	71.3	2.54	85.0	3.27	98.7	3.93	105.6	3.95	112.5	3.97	121.2	4.00	123.7	4.04
	32.0	71.3	2.55	85.0	3.28	98.7	3.93	105.6	3.95	112.5	3.98	121.2	4.01	123.7	4.05
	39.2	71.3	2.56	85.0	3.29	98.7	3.95	105.6	3.97	112.5	3.99	121.2	4.03	123.7	4.06
	44.6	71.3	2.60	85.0	3.35	98.7	4.02	105.6	4.04	112.5	4.06	121.2	4.10	123.7	4.14
	50.0	71.3	2.78	85.0	3.39	98.7	4.03	105.6	4.36	112.5	4.69	121.0	4.98	123.8	4.81
	53.6	71.3	2.84	85.0	3.46	98.7	4.11	105.6	4.45	112.5	4.78	119.7	4.96	122.1	4.78
	57.2	71.3	2.89	85.0	3.52	98.7	4.19	105.6	4.53	112.5	4.87	117.9	4.96	120.7	4.77
	60.8	71.3	2.94	85.0	3.59	98.7	4.27	105.6	4.61	112.5	4.97	116.6	4.99	119.0	5.04
	64.4	71.3	3.00	85.0	3.66	98.7	4.36	105.6	4.74	112.5	5.20	114.9	5.24	117.6	5.29
	68.0	71.3	3.06	85.0	3.74	98.7	4.61	105.6	5.10	110.7	5.46	113.5	5.50	115.9	5.55
	69.8	71.3	3.09	85.0	3.85	98.7	4.78	105.6	5.28	110.1	5.59	112.5	5.63	115.2	5.68
	73.4	71.3	3.24	85.0	4.12	98.7	5.13	105.6	5.67	108.3	5.83	111.1	5.89	113.5	5.94
	77.0	71.3	3.44	85.0	4.41	98.7	5.48	105.6	6.07	107.0	6.09	109.4	6.15	112.1	6.20
	80.6	71.3	3.68	85.0	4.71	98.7	5.86	103.9	6.33	105.3	6.35	108.0	6.41	110.4	6.46
	84.2	71.3	3.93	85.0	5.03	98.7	6.27	102.5	6.58	103.9	6.61	106.3	6.67	109.0	6.73
	87.8	71.3	4.18	85.0	5.36	98.7	6.69	100.8	6.84	102.2	6.87	104.9	6.93	107.3	7.00
	91.4	71.3	4.45	85.0	5.72	98.1	7.05	99.4	7.09	100.8	7.12	103.2	7.19	105.9	7.26
	95.0	71.3	4.73	85.0	6.09	96.7	7.31	97.7	7.35	99.1	7.39	101.5	7.46	104.2	7.53
	98.6	71.3	5.04	85.0	6.48	95.0	7.58	96.3	7.61	97.4	7.64	100.1	7.72	102.5	7.79
	102.2	71.3	5.35	85.0	6.91	93.3	7.83	94.6	7.87	96.0	7.91	98.4	7.99	101.1	8.07
105.8	67.4	5.96	80.8	7.67	91.9	9.21	92.9	8.53	94.2	8.57	96.6	8.65	99.3	8.73	
111.2	62.8	6.48	76.5	8.34	87.5	10.23	88.9	9.63	90.5	9.24	93.0	9.10	95.9	9.18	
116.6	59.2	8.63	74.0	11.10	84.6	10.75	85.8	9.78	87.2	9.83	89.8	9.77	92.8	9.86	
122.0	54.2	8.47	66.3	10.90	75.5	11.33	76.5	10.58	77.8	10.49	80.2	10.44	83.4	10.31	
125.6	41.1	7.15	49.3	9.20	56.6	9.65	57.7	9.63	59.5	9.46	63.9	9.32	67.8	9.03	
100%	23.0	64.8	2.22	77.1	2.85	89.8	3.55	96.0	3.92	102.2	3.94	114.9	3.98	121.3	4.01
	32.0	64.8	2.23	77.1	2.85	89.8	3.55	96.0	3.93	102.2	3.95	114.9	3.98	121.3	4.02
	39.2	64.8	2.23	77.1	2.86	89.8	3.57	96.0	3.94	102.2	3.96	114.9	4.00	121.3	4.03
	44.6	64.8	2.28	77.1	2.91	89.8	3.63	96.0	4.02	102.2	4.04	114.9	4.07	121.3	4.11
	50.0	64.8	2.52	77.1	3.06	89.8	3.62	96.0	3.91	102.2	4.22	114.8	4.78	121.3	4.96
	53.6	64.8	2.55	77.1	3.10	89.8	3.67	96.0	3.96	102.2	4.30	114.8	4.86	119.6	4.92
	57.2	64.8	2.60	77.1	3.15	89.8	3.73	96.0	4.03	102.2	4.38	114.8	4.94	118.3	4.89
	60.8	64.8	2.65	77.1	3.23	89.8	3.81	96.0	4.12	102.2	4.48	114.4	5.05	116.5	5.00
	64.4	64.8	2.71	77.1	3.30	89.8	3.89	96.0	4.20	102.2	4.57	112.8	5.15	115.2	5.23
	68.0	64.8	2.76	77.1	3.35	89.8	4.02	96.0	4.42	102.2	4.86	111.1	5.42	113.5	5.51
	69.8	64.8	2.78	77.1	3.38	89.8	4.15	96.0	4.57	102.2	5.02	110.4	5.61	112.8	5.66
	73.4	64.8	2.85	77.1	3.61	89.8	4.47	96.0	4.92	102.2	5.40	109.1	5.93	111.1	5.99
	77.0	64.8	3.04	77.1	3.84	89.8	4.75	96.0	5.23	102.2	5.78	107.3	6.15	109.7	6.21
	80.6	64.8	3.24	77.1	4.11	89.8	5.10	96.0	5.61	102.2	6.20	105.6	6.37	108.0	6.42
	84.2	64.8	3.44	77.1	4.39	89.8	5.45	96.0	6.01	101.8	6.57	104.2	6.67	106.6	6.73
	87.8	64.8	3.66	77.1	4.67	89.8	5.81	96.0	6.47	100.6	6.83	101.8	6.94	104.9	7.01
	91.4	64.8	3.89	77.1	4.98	89.8	6.20	96.0	6.85	98.7	7.08	101.3	7.14	103.5	7.21
	95.0	64.8	4.14	77.1	5.30	89.8	6.61	96.0	7.30	97.0	7.34	99.4	7.40	101.8	7.47
	98.6	64.8	4.41	77.1	5.64	89.8	7.04	94.3	7.56	95.8	7.60	97.9	7.65	100.3	7.72
	102.2	64.8	4.69	77.1	6.01	89.8	7.49	93.0	7.81	93.5	7.85	96.7	7.91	97.9	7.98
105.8	61.2	5.21	73.3	6.68	85.4	8.32	91.3	8.47	92.3	8.51	94.6	8.59	97.0	8.66	
111.2	57.0	5.67	69.4	7.26	81.3	9.25	87.4	9.56	88.6	9.17	91.0	9.03	93.6	9.11	
116.6	53.8	7.54	67.1	9.66	78.6	9.71	84.3	9.71	85.4	9.76	87.9	9.70	90.6	9.79	
122.0	49.3	7.41	60.2	9.48	70.2	10.24	75.2	10.51	76.2	10.42	78.5	10.36	81.4	10.23	
125.6	37.3	6.25	44.7	8.00	52.6	8.72	56.6	9.56	58.2	9.39	62.6	9.25	66.1	8.96	

GMV5 DC Inverter VRF Units Technical Sales Guide

Combination	Outdoor air temp (°FDB)	Indoor air temp													
		57.2°FWB		60.8°FWB		64.4°FWB		66.2°FWB		68°FWB		71.6°FWB		75.2°FWB	
		68°FDB		73.4°FDB		78.8°FDB		80.6°FDB		82.4°FDB		86°FDB		89.6°FDB	
		TC	PI	TC	PI	TC	PI	TC	PI	TC	PI	TC	PI	TC	PI
		kBtu/h	kW	kBtu/h	kW	kBtu/h	kW	kBtu/h	kW	kBtu/h	kW	kBtu/h	kW	kBtu/h	kW
90%	23.0	58.3	1.94	69.4	2.45	80.8	3.03	86.4	3.35	91.9	3.68	103.2	3.94	114.5	3.98
	32.0	58.3	1.94	69.4	2.46	80.8	3.04	86.4	3.35	91.9	3.69	103.2	3.95	114.5	3.98
	39.2	58.3	1.95	69.4	2.47	80.8	3.05	86.4	3.37	91.9	3.70	103.2	3.96	114.5	4.00
	44.6	58.3	1.99	69.4	2.51	80.8	3.10	86.4	3.43	91.9	3.77	103.2	4.04	114.5	4.07
	50.0	58.3	2.20	69.4	2.64	80.8	3.09	86.4	3.48	92.0	3.71	103.3	4.25	114.5	4.81
	53.6	58.3	2.23	69.4	2.67	80.8	3.13	86.4	3.53	92.0	3.78	103.3	4.32	114.5	4.88
	57.2	58.3	2.27	69.4	2.72	80.8	3.19	86.4	3.58	92.0	3.84	103.3	4.40	114.5	4.96
	60.8	58.3	2.32	69.4	2.78	80.8	3.26	86.4	3.66	92.0	3.93	103.3	4.49	114.1	5.05
	64.4	58.3	2.37	69.4	2.84	80.8	3.32	86.4	3.73	92.0	4.01	103.3	4.60	113.1	5.23
	68.0	58.3	2.40	69.4	2.89	80.8	3.43	86.4	3.81	92.0	4.17	103.3	4.94	111.1	5.45
	69.8	58.3	2.43	69.4	2.92	80.8	3.55	86.4	3.94	92.0	4.32	103.3	5.11	110.4	5.58
	73.4	58.3	2.49	69.4	3.12	80.8	3.81	86.4	4.23	92.0	4.62	103.3	5.49	108.7	5.86
	77.0	58.3	2.65	69.4	3.32	80.8	4.06	86.4	4.52	92.0	4.94	103.3	5.87	107.3	6.10
	80.6	58.3	2.83	69.4	3.54	80.8	4.35	86.4	4.82	92.0	5.29	103.3	6.26	105.6	6.37
	84.2	58.3	3.00	69.4	3.78	80.8	4.66	86.4	5.15	92.0	5.65	102.2	6.57	104.2	6.63
	87.8	58.3	3.19	69.4	4.03	80.8	4.96	86.4	5.50	92.0	6.03	100.5	6.81	102.5	6.90
	91.4	58.3	3.39	69.4	4.29	80.8	5.29	86.4	5.85	92.0	6.41	99.1	7.08	101.1	7.15
	95.0	58.3	3.61	69.4	4.57	80.8	5.64	86.4	6.23	92.0	6.86	97.4	7.34	99.4	7.40
	98.6	58.3	3.85	69.4	4.87	80.8	6.01	84.9	6.46	92.0	7.34	95.7	7.60	98.1	7.58
	102.2	58.3	4.10	69.4	5.18	80.8	6.40	83.7	6.67	92.0	7.78	94.3	7.88	96.3	7.86
105.8	55.1	4.55	66.0	5.76	76.8	7.11	82.1	7.23	87.4	7.96	92.7	8.51	94.8	8.59	
111.2	51.3	4.95	62.5	6.26	73.2	7.90	78.6	8.17	84.0	8.57	89.2	8.95	91.5	9.03	
116.6	48.4	6.58	60.4	8.33	70.7	8.29	75.9	8.29	80.9	9.12	86.2	9.61	88.5	9.70	
122.0	44.3	6.46	54.2	8.18	63.1	8.75	67.7	8.98	72.2	9.74	76.9	10.27	79.5	10.14	
125.6	33.6	5.45	40.3	6.90	47.3	7.45	51.0	8.17	55.2	8.78	61.3	9.17	64.6	8.89	
80%	23.0	51.8	1.67	61.7	2.07	71.9	2.57	76.8	2.83	81.6	3.09	91.9	3.67	101.8	3.93
	32.0	51.8	1.68	61.7	2.07	71.9	2.57	76.8	2.83	81.6	3.10	91.9	3.67	101.8	3.94
	39.2	51.8	1.68	61.7	2.08	71.9	2.58	76.8	2.84	81.6	3.11	91.9	3.69	101.8	3.95
	44.6	51.8	1.72	61.7	2.12	71.9	2.63	76.8	2.90	81.6	3.16	91.9	3.76	101.8	4.02
	50.0	51.8	2.00	61.7	2.39	71.9	2.81	76.8	3.03	81.7	3.24	91.9	3.71	101.8	4.30
	53.6	51.8	2.03	61.7	2.43	71.9	2.86	76.8	3.09	81.7	3.31	91.9	3.77	101.8	4.27
	57.2	51.8	2.07	61.7	2.48	71.9	2.91	76.8	3.14	81.7	3.37	91.9	3.84	101.8	4.37
	60.8	51.8	2.10	61.7	2.52	71.9	2.97	76.8	3.20	81.7	3.42	91.9	3.92	101.8	4.53
	64.4	51.8	2.14	61.7	2.57	71.9	3.04	76.8	3.27	81.7	3.49	91.9	4.01	101.8	4.84
	68.0	51.8	2.17	61.7	2.62	71.9	3.09	76.8	3.33	81.7	3.56	91.9	4.16	101.8	5.02
	69.8	51.8	2.19	61.7	2.64	71.9	3.12	76.8	3.36	81.7	3.64	91.9	4.31	101.8	5.37
	73.4	51.8	2.23	61.7	2.70	71.9	3.27	76.8	3.58	81.7	3.90	91.9	4.61	101.8	5.74
	77.0	51.8	2.30	61.7	2.86	71.9	3.49	76.8	3.83	81.7	4.16	91.9	4.93	101.8	6.13
	80.6	51.8	2.45	61.7	3.05	71.9	3.72	76.8	4.08	81.7	4.46	91.9	5.26	101.8	6.34
	84.2	51.8	2.61	61.7	3.25	71.9	3.97	76.8	4.35	81.5	4.76	91.9	5.62	101.8	6.57
	87.8	51.8	2.76	61.7	3.45	71.9	4.22	76.8	4.63	81.5	5.07	91.9	6.00	100.1	6.81
	91.4	51.8	2.94	61.7	3.85	71.9	4.50	76.8	4.94	81.5	5.40	91.9	6.40	98.7	7.06
	95.0	51.8	3.12	61.7	3.85	71.9	4.78	76.8	5.26	81.5	5.75	91.9	6.83	97.0	7.32
	98.6	51.8	3.31	61.7	4.14	71.9	5.09	75.4	5.61	81.5	6.13	91.9	7.27	95.7	7.59
	102.2	51.8	3.50	61.7	4.40	71.9	5.41	74.4	5.97	81.5	6.53	91.9	7.75	93.9	7.87
105.8	49.0	3.93	58.6	4.85	68.3	6.03	73.0	6.11	77.5	6.67	87.4	7.92	92.5	8.49	
111.2	45.6	4.27	55.5	5.27	65.0	6.69	69.9	6.90	74.4	7.19	84.1	8.33	89.3	8.93	
116.6	43.0	5.69	53.7	7.01	62.9	7.03	67.4	7.00	71.7	7.65	81.3	8.95	86.4	9.58	
122.0	39.4	5.58	48.1	6.89	56.1	7.41	60.1	7.58	64.0	8.17	72.6	9.56	77.6	10.02	
125.6	29.9	4.71	35.8	5.81	42.0	6.31	45.3	6.90	48.9	7.36	57.9	8.54	63.1	8.78	

Combination	Outdoor air temp (°FDB)	Indoor air temp													
		57.2°FWB		60.8°FWB		64.4°FWB		66.2°FWB		68°FWB		71.6°FWB		75.2°FWB	
		68°FDB		73.4°FDB		78.8°FDB		80.6°FDB		82.4°FDB		86°FDB		89.6°FDB	
		TC	PI	TC	PI	TC	PI	TC	PI	TC	PI	TC	PI	TC	PI
	kBtu/h	kW	kBtu/h	kW	kBtu/h	kW	kBtu/h	kW	kBtu/h	kW	kBtu/h	kW	kBtu/h	kW	
70%	23.0	45.4	1.43	54.0	1.76	62.9	2.14	67.2	2.35	71.7	2.56	80.2	3.01	89.1	3.50
	32.0	45.4	1.43	54.0	1.77	62.9	2.14	67.2	2.35	71.7	2.56	80.2	3.02	89.1	3.51
	39.2	45.4	1.43	54.0	1.77	62.9	2.15	67.2	2.36	71.7	2.57	80.2	3.03	89.1	3.52
	44.6	45.4	1.46	54.0	1.81	62.9	2.19	67.2	2.40	71.7	2.62	80.2	3.08	89.1	3.59
	50.0	45.4	1.76	54.0	2.09	62.9	2.43	67.2	2.62	71.5	2.80	80.4	3.19	89.1	3.58
	53.6	45.4	1.78	54.0	2.12	62.9	2.48	67.2	2.67	71.5	2.85	80.4	3.25	89.1	3.65
	57.2	45.4	1.81	54.0	2.15	62.9	2.52	67.2	2.71	71.5	2.90	80.4	3.31	89.1	3.72
	60.8	45.4	1.84	54.0	2.19	62.9	2.57	67.2	2.76	71.5	2.96	80.4	3.36	89.1	3.79
	64.4	45.4	1.87	54.0	2.23	62.9	2.62	67.2	2.81	71.5	3.01	80.4	3.43	89.1	3.87
	68.0	45.4	1.90	54.0	2.27	62.9	2.67	67.2	2.86	71.5	3.07	80.4	3.50	89.1	3.97
	69.8	45.4	1.92	54.0	2.29	62.9	2.69	67.2	2.89	71.5	3.10	80.4	3.54	89.1	4.11
	73.4	45.4	1.95	54.0	2.33	62.9	2.75	67.2	2.99	71.5	3.26	80.4	3.81	89.1	4.41
	77.0	45.4	1.99	54.0	2.43	62.9	2.92	67.2	3.20	71.5	3.47	80.4	4.07	89.1	4.71
	80.6	45.4	2.11	54.0	2.59	62.9	3.12	67.2	3.40	71.5	3.71	80.4	4.35	89.1	5.04
	84.2	45.4	2.23	54.0	2.75	62.9	3.32	67.2	3.63	71.5	3.95	80.4	4.63	89.1	5.38
	87.8	45.4	2.36	54.0	2.91	62.9	3.53	67.2	3.86	71.5	4.20	80.4	4.94	89.1	5.74
	91.4	45.4	2.51	54.0	3.10	62.9	3.76	67.2	4.10	71.5	4.48	80.4	5.26	89.1	6.12
	95.0	45.4	2.66	54.0	3.29	62.9	3.98	67.2	4.37	71.5	4.76	80.4	5.61	89.1	6.52
	98.6	45.4	2.80	54.0	3.48	62.9	4.24	66.0	4.64	71.5	5.07	80.4	5.97	89.1	6.95
	102.2	45.4	2.97	54.0	3.69	62.9	4.50	65.1	4.93	71.5	5.38	80.4	6.35	89.1	7.40
105.8	42.9	3.35	51.3	4.14	59.8	5.02	63.9	5.07	68.0	5.52	76.5	6.51	85.0	7.57	
111.2	39.9	3.64	48.6	4.50	56.9	5.58	61.2	5.72	65.3	5.95	73.6	6.84	82.0	7.96	
116.6	37.7	4.84	47.0	5.99	55.0	5.86	59.0	5.81	62.9	6.33	71.1	7.35	79.3	8.55	
122.0	34.5	4.76	42.1	5.88	49.1	6.18	52.6	6.29	56.1	6.76	63.5	7.85	71.3	8.94	
125.6	26.1	4.01	31.3	4.96	36.8	5.26	39.6	5.72	42.9	6.10	50.6	7.01	57.9	7.83	
60%	23.0	38.9	1.20	46.3	1.46	53.9	1.75	57.6	1.91	61.4	2.08	68.9	2.43	76.5	2.80
	32.0	38.9	1.20	46.3	1.47	53.9	1.76	57.6	1.92	61.4	2.08	68.9	2.43	76.5	2.81
	39.2	38.9	1.21	46.3	1.47	53.9	1.76	57.6	1.92	61.4	2.09	68.9	2.44	76.5	2.82
	44.6	38.9	1.23	46.3	1.50	53.9	1.80	57.6	1.96	61.4	2.13	68.9	2.48	76.5	2.87
	50.0	38.9	1.53	46.3	1.79	53.9	2.08	57.6	2.22	61.3	2.37	68.9	2.69	76.5	3.01
	53.6	38.9	1.55	46.3	1.82	53.9	2.12	57.6	2.26	61.3	2.41	68.9	2.74	76.5	3.06
	57.2	38.9	1.57	46.3	1.85	53.9	2.14	57.6	2.30	61.3	2.46	68.9	2.78	76.5	3.12
	60.8	38.9	1.59	46.3	1.88	53.9	2.18	57.6	2.34	61.3	2.50	68.9	2.83	76.5	3.18
	64.4	38.9	1.62	46.3	1.91	53.9	2.22	57.6	2.38	61.3	2.55	68.9	2.88	76.5	3.24
	68.0	38.9	1.64	46.3	1.95	53.9	2.26	57.6	2.43	61.3	2.60	68.9	2.94	76.5	3.31
	69.8	38.9	1.66	46.3	1.96	53.9	2.28	57.6	2.45	61.3	2.62	68.9	2.97	76.5	3.34
	73.4	38.9	1.68	46.3	2.00	53.9	2.32	57.6	2.50	61.3	2.67	68.9	3.09	76.5	3.55
	77.0	38.9	1.71	46.3	2.04	53.9	2.41	57.6	2.62	61.3	2.83	68.9	3.30	76.5	3.79
	80.6	38.9	1.78	46.3	2.15	53.9	2.57	57.6	2.79	61.3	3.02	68.9	3.51	76.5	4.04
	84.2	38.9	1.88	46.3	2.28	53.9	2.74	57.6	2.97	61.3	3.22	68.9	3.75	76.5	4.32
	87.8	38.9	2.00	46.3	2.43	53.9	2.90	57.6	3.16	61.3	3.42	68.9	3.98	76.5	4.59
	91.4	38.9	2.11	46.3	2.57	53.9	3.08	57.6	3.36	61.3	3.64	68.9	4.24	76.5	4.90
	95.0	38.9	2.23	46.3	2.73	53.9	3.27	57.6	3.56	61.3	3.87	68.9	4.52	76.5	5.21
	98.6	38.9	2.36	46.3	2.88	53.9	3.46	56.6	3.78	61.3	4.10	68.9	4.80	76.5	5.55
	102.2	38.9	2.49	46.3	3.05	53.9	3.67	55.8	4.00	61.3	4.36	68.9	5.10	76.5	5.90
105.8	36.7	2.81	44.0	3.43	51.2	4.12	54.8	4.13	58.3	4.49	65.6	5.24	72.9	6.05	
111.2	34.2	3.06	41.7	3.73	48.8	4.57	52.4	4.67	56.0	4.83	63.1	5.51	70.3	6.36	
116.6	32.3	4.07	40.3	4.97	47.2	4.80	50.6	4.74	53.9	5.14	61.0	5.92	68.0	6.83	
122.0	29.6	4.00	36.1	4.88	42.1	5.06	45.1	5.13	48.1	5.49	54.4	6.32	61.2	7.14	
125.6	22.4	3.37	26.8	4.12	31.5	4.31	34.0	4.67	36.8	4.95	43.4	5.65	49.7	6.26	

GMV5 DC Inverter VRF Units Technical Sales Guide

Combination	Outdoor air temp (°FDB)	Indoor air temp													
		57.2°FWB		60.8°FWB		64.4°FWB		66.2°FWB		68°FWB		71.6°FWB		75.2°FWB	
		68°FDB		73.4°FDB		78.8°FDB		80.6°FDB		82.4°FDB		86°FDB		89.6°FDB	
		TC	PI	TC	PI	TC	PI	TC	PI	TC	PI	TC	PI	TC	PI
		kBtu/h	kW	kBtu/h	kW	kBtu/h	kW	kBtu/h	kW	kBtu/h	kW	kBtu/h	kW	kBtu/h	kW
50%	23.0	32.4	0.99	38.6	1.19	44.9	1.41	48.0	1.52	51.1	1.64	57.4	1.90	63.8	2.18
	32.0	32.4	1.00	38.6	1.19	44.9	1.41	48.0	1.52	51.1	1.65	57.4	1.91	63.8	2.18
	39.2	32.4	1.00	38.6	1.20	44.9	1.41	48.0	1.53	51.1	1.65	57.4	1.91	63.8	2.19
	44.6	32.4	1.02	38.6	1.22	44.9	1.44	48.0	1.56	51.1	1.68	57.4	1.95	63.8	2.23
	50.0	32.4	1.32	38.6	1.53	44.9	1.74	48.0	1.86	51.1	1.97	57.4	2.21	63.8	2.47
	53.6	32.4	1.33	38.6	1.54	44.9	1.77	48.0	1.88	51.1	2.01	57.4	2.25	63.8	2.51
	57.2	32.4	1.35	38.6	1.56	44.9	1.79	48.0	1.92	51.1	2.04	57.4	2.29	63.8	2.56
	60.8	32.4	1.37	38.6	1.58	44.9	1.82	48.0	1.95	51.1	2.07	57.4	2.33	63.8	2.60
	64.4	32.4	1.39	38.6	1.61	44.9	1.85	48.0	1.98	51.1	2.11	57.4	2.37	63.8	2.65
	68.0	32.4	1.41	38.6	1.63	44.9	1.88	48.0	2.02	51.1	2.14	57.4	2.42	63.8	2.70
	69.8	32.4	1.42	38.6	1.65	44.9	1.90	48.0	2.03	51.1	2.16	57.4	2.44	63.8	2.73
	73.4	32.4	1.44	38.6	1.67	44.9	1.93	48.0	2.07	51.1	2.20	57.4	2.48	63.8	2.78
	77.0	32.4	1.46	38.6	1.70	44.9	1.97	48.0	2.11	51.1	2.27	57.4	2.61	63.8	2.97
	80.6	32.4	1.49	38.6	1.77	44.9	2.08	48.0	2.24	51.1	2.41	57.4	2.77	63.8	3.17
	84.2	32.4	1.56	38.6	1.87	44.9	2.20	48.0	2.38	50.9	2.57	57.4	2.95	63.8	3.37
	87.8	32.4	1.65	38.6	1.98	44.9	2.35	48.0	2.53	50.9	2.73	57.4	3.14	63.8	3.59
	91.4	32.4	1.75	38.6	2.10	44.9	2.48	48.0	2.68	50.9	2.89	57.4	3.34	63.8	3.82
	95.0	32.4	1.85	38.6	2.21	44.9	2.62	48.0	2.83	50.9	3.06	57.4	3.54	63.8	4.05
	98.6	32.4	1.95	38.6	2.34	44.9	2.77	47.1	3.00	50.9	3.25	57.4	3.76	63.8	4.31
	102.2	32.4	2.06	38.6	2.47	44.9	2.93	46.5	3.18	50.9	3.44	57.4	3.98	63.8	4.58
105.8	30.6	2.33	36.6	2.79	42.7	3.30	45.6	3.29	48.4	3.55	54.7	4.11	60.8	4.70	
111.2	28.5	2.53	34.7	3.03	40.6	3.66	43.7	3.71	46.5	3.82	52.6	4.32	58.7	4.95	
116.6	26.9	3.37	33.6	4.04	39.3	3.85	42.1	3.77	44.8	4.07	50.8	4.64	56.8	5.31	
122.0	24.6	3.31	30.1	3.96	35.1	4.06	37.6	4.08	40.0	4.35	45.4	4.96	51.0	5.55	
125.6	18.7	2.79	22.4	3.34	26.3	3.45	28.3	3.71	30.5	3.92	36.2	4.43	41.5	4.86	

GMV-120WM/B-F(U), GMV-120WM/B-U(U)

TC—Total capacity of outdoor unit; PI—Power input of outdoor unit

Combination	Outdoor air temp (°FDB)	Indoor air temp													
		57.2°FWB		60.8°FWB		64.4°FWB		66.2°FWB		68°FWB		71.6°FWB		75.2°FWB	
		68°FDB		73.4°FDB		78.8°FDB		80.6°FDB		82.4°FDB		86°FDB		89.6°FDB	
		TC	PI	TC	PI	TC	PI	TC	PI	TC	PI	TC	PI	TC	PI
		kBtu/h	kW	kBtu/h	kW	kBtu/h	kW	kBtu/h	kW	kBtu/h	kW	kBtu/h	kW	kBtu/h	kW
135%	23.0	105.4	4.42	125.6	5.38	145.7	5.45	151.3	5.48	154.0	5.51	158.0	5.57	161.9	5.63
	32.0	105.4	4.43	125.6	5.39	145.7	5.46	151.3	5.49	154.0	5.52	158.0	5.58	161.9	5.64
	39.2	105.4	4.45	125.6	5.41	145.7	5.48	151.3	5.51	154.0	5.54	158.0	5.60	161.9	5.66
	44.6	105.4	4.53	125.6	5.51	145.7	5.58	151.3	5.61	154.0	5.64	158.0	5.71	161.9	5.77
	50.0	105.4	4.61	125.6	5.63	145.7	6.70	151.3	6.85	153.0	6.71	156.9	6.43	160.7	6.13
	53.6	105.4	4.69	125.6	5.74	145.7	6.83	149.1	6.81	151.3	6.67	154.7	6.37	158.6	6.28
	57.2	105.4	4.78	125.6	5.85	145.3	6.91	147.4	6.78	149.1	6.63	153.0	6.58	156.9	6.64
	60.8	105.4	4.87	125.6	5.97	143.6	6.89	145.3	6.83	147.0	6.86	150.9	6.93	154.7	6.99
	64.4	105.4	4.96	125.6	6.09	141.4	7.14	143.1	7.18	145.3	7.22	149.1	7.29	153.0	7.36
	68.0	105.4	5.07	125.6	6.48	139.3	7.49	141.4	7.53	143.1	7.57	147.0	7.64	150.9	7.72
	69.8	105.4	5.20	125.6	6.71	138.4	7.67	140.6	7.71	142.3	7.75	146.1	7.83	150.0	7.90
	73.4	105.4	5.58	125.6	7.20	136.7	8.02	138.4	8.06	140.1	8.10	144.0	8.18	147.9	8.26
	77.0	105.4	5.96	125.6	7.71	134.6	8.37	136.7	8.41	138.4	8.46	142.3	8.54	146.1	8.63
	80.6	105.4	6.36	125.6	8.25	132.9	7.37	134.6	8.77	136.3	8.81	140.1	8.91	144.0	9.00
	84.2	105.4	6.79	125.6	8.81	130.7	9.07	132.4	9.12	134.6	9.18	138.4	9.27	142.3	9.37
	87.8	105.4	7.25	125.1	9.33	128.6	9.43	130.7	9.49	132.4	9.53	136.3	9.64	140.1	9.74
	91.4	105.4	7.72	123.0	9.68	126.9	9.77	128.6	9.84	130.7	9.89	134.6	10.00	138.0	10.12
	95.0	105.4	8.23	120.9	10.03	124.7	10.15	126.9	10.20	128.6	10.26	132.4	10.38	136.3	10.49
	98.6	105.4	8.76	119.1	10.39	123.0	10.51	124.7	10.57	126.9	10.63	130.3	10.75	134.1	10.88
	102.2	105.4	9.33	117.0	10.74	120.9	10.86	123.0	10.93	124.7	11.00	128.6	11.12	132.4	11.25
105.8	99.6	10.38	114.8	12.63	118.5	12.79	120.6	11.83	122.3	11.90	126.1	12.04	129.9	12.16	
111.2	92.8	11.28	108.8	13.74	112.9	14.21	115.4	13.36	117.4	12.82	121.3	12.66	125.4	12.79	
116.6	87.5	15.01	105.1	18.28	109.1	14.92	111.4	13.57	113.1	13.64	117.2	13.59	121.3	13.74	
122.0	80.1	14.74	94.3	17.95	97.4	15.73	99.3	14.69	100.9	14.56	104.6	14.53	109.0	14.36	
125.6	60.7	12.43	70.1	15.14	73.0	13.40	74.8	13.36	77.1	13.13	83.4	12.97	88.6	12.58	

Combination	Outdoor air temp (°FDB)	Indoor air temp													
		57.2°FWB		60.8°FWB		64.4°FWB		66.2°FWB		68°FWB		71.6°FWB		75.2°FWB	
		68°FDB		73.4°FDB		78.8°FDB		80.6°FDB		82.4°FDB		86°FDB		89.6°FDB	
		TC	PI	TC	PI	TC	PI	TC	PI	TC	PI	TC	PI	TC	PI
		kBtu/h	kW	kBtu/h	kW	kBtu/h	kW	kBtu/h	kW	kBtu/h	kW	kBtu/h	kW	kBtu/h	kW
120%	23.0	97.3	3.94	115.7	5.09	134.6	5.41	144.0	5.44	151.5	5.47	154.9	5.53	158.3	5.59
	32.0	97.3	3.94	115.7	5.10	134.6	5.42	144.0	5.45	151.5	5.48	154.9	5.54	158.3	5.60
	39.2	97.3	3.96	115.7	5.12	134.6	5.44	144.0	5.47	151.5	5.50	154.9	5.56	158.3	5.62
	44.6	97.3	4.03	115.7	5.22	134.6	5.54	144.0	5.57	151.5	5.60	154.9	5.66	158.3	5.72
	50.0	97.3	4.20	115.7	5.13	134.6	6.11	144.0	6.60	150.9	6.89	154.3	6.62	157.7	6.36
	53.6	97.3	4.29	115.7	5.23	134.6	6.23	144.0	6.73	148.7	6.85	152.1	6.59	155.6	6.32
	57.2	97.3	4.37	115.7	5.34	134.6	6.35	144.0	6.86	146.6	6.81	150.4	6.55	153.9	6.59
	60.8	97.3	4.45	115.7	5.44	134.6	6.47	143.1	6.91	144.9	6.82	148.3	6.89	151.7	6.94
	64.4	97.3	4.53	115.7	5.55	134.6	6.70	141.0	7.14	142.7	7.17	146.1	7.24	150.0	7.30
	68.0	97.3	4.62	115.7	5.77	134.6	7.20	139.3	7.49	141.0	7.52	144.4	7.59	147.9	7.65
	69.8	97.3	4.66	115.7	5.97	134.6	7.45	138.0	7.67	139.7	7.70	143.6	7.76	147.0	7.84
	73.4	97.3	4.99	115.7	6.40	134.6	7.98	136.3	8.01	138.0	8.05	141.4	8.13	144.9	8.19
	77.0	97.3	5.32	115.7	6.85	132.4	8.33	134.1	8.36	135.9	8.40	139.7	8.48	143.1	8.56
	80.6	97.3	5.69	115.7	7.32	130.7	8.67	132.4	8.72	134.1	8.76	137.6	8.84	141.0	8.92
	84.2	97.3	6.06	115.7	7.82	128.6	9.02	130.3	9.07	132.0	9.11	135.4	9.20	139.3	9.29
	87.8	97.3	6.47	115.7	8.34	126.9	9.38	128.6	9.42	130.3	9.47	133.7	9.57	137.1	9.66
	91.4	97.3	6.89	115.7	8.91	124.7	9.73	126.4	9.78	128.1	9.82	131.6	9.93	135.0	10.03
	95.0	97.3	7.33	115.7	9.49	122.6	10.08	124.3	10.13	126.4	10.19	129.9	10.30	133.3	10.40
	98.6	97.3	7.80	115.7	10.11	120.9	10.44	122.6	10.50	124.3	10.55	127.7	10.66	131.1	10.78
	102.2	97.3	8.30	115.3	10.67	118.7	10.80	120.4	10.86	122.1	10.92	126.0	11.04	129.4	11.15
105.8	91.9	9.24	109.9	11.95	116.5	12.70	118.1	11.76	120.2	11.82	123.6	11.94	127.0	12.07	
111.2	85.6	10.04	104.1	13.00	110.9	14.11	113.1	13.28	115.4	12.74	119.0	12.56	122.6	12.69	
116.6	80.7	13.37	100.7	17.30	107.3	14.82	109.1	13.48	111.3	13.55	114.9	13.49	118.6	13.63	
122.0	73.9	13.12	90.3	16.98	95.7	15.63	97.3	14.59	99.2	14.47	102.6	14.42	106.6	14.25	
125.6	56.0	11.07	67.1	14.33	71.7	13.31	73.3	13.28	75.9	13.04	81.8	12.87	86.6	12.49	
110%	23.0	89.1	3.48	106.3	4.48	123.4	5.38	132.0	5.41	140.6	5.44	151.5	5.49	154.6	5.54
	32.0	89.1	3.49	106.3	4.49	123.4	5.39	132.0	5.42	140.6	5.45	151.5	5.50	154.6	5.55
	39.2	89.1	3.50	106.3	4.50	123.4	5.41	132.0	5.44	140.6	5.47	151.5	5.52	154.6	5.57
	44.6	89.1	3.57	106.3	4.59	123.4	5.51	132.0	5.54	140.6	5.57	151.5	5.62	154.6	5.67
	50.0	89.1	3.81	106.3	4.65	123.4	5.53	132.0	5.97	140.6	6.43	151.3	6.82	154.7	6.59
	53.6	89.1	3.89	106.3	4.74	123.4	5.63	132.0	6.09	140.6	6.55	149.6	6.79	152.6	6.55
	57.2	89.1	3.96	106.3	4.82	123.4	5.74	132.0	6.20	140.6	6.67	147.4	6.79	150.9	6.54
	60.8	89.1	4.03	106.3	4.92	123.4	5.85	132.0	6.32	140.6	6.81	145.7	6.83	148.7	6.90
	64.4	89.1	4.11	106.3	5.01	123.4	5.97	132.0	6.50	140.6	7.13	143.6	7.18	147.0	7.25
	68.0	89.1	4.19	106.3	5.12	123.4	6.32	132.0	6.98	138.4	7.48	141.9	7.53	144.9	7.60
	69.8	89.1	4.23	106.3	5.27	123.4	6.55	132.0	7.24	137.6	7.65	140.6	7.71	144.0	7.78
	73.4	89.1	4.43	106.3	5.65	123.4	7.02	132.0	7.76	135.4	7.99	138.9	8.07	141.9	8.14
	77.0	89.1	4.72	106.3	6.04	123.4	7.51	132.0	8.32	133.7	8.34	136.7	8.42	140.1	8.49
	80.6	89.1	5.04	106.3	6.46	123.4	8.03	129.9	8.67	131.6	8.69	135.0	8.77	138.0	8.85
	84.2	89.1	5.38	106.3	6.89	123.4	8.58	128.1	9.02	129.9	9.06	132.9	9.14	136.3	9.22
	87.8	89.1	5.73	106.3	7.35	123.4	9.16	126.0	9.37	127.7	9.41	131.1	9.49	134.1	9.58
	91.4	89.1	6.09	106.3	7.83	122.6	9.66	124.3	9.72	126.0	9.76	129.0	9.85	132.4	9.95
	95.0	89.1	6.48	106.3	8.34	120.9	10.01	122.1	10.07	123.9	10.12	126.9	10.22	130.3	10.31
	98.6	89.1	6.90	106.3	8.88	118.7	10.38	120.4	10.42	121.7	10.47	125.1	10.58	128.1	10.67
	102.2	89.1	7.33	106.3	9.46	116.6	10.73	118.3	10.78	120.0	10.84	123.0	10.94	126.4	11.05
105.8	84.2	8.17	101.0	10.51	114.8	12.62	116.1	11.68	117.8	11.74	120.8	11.85	124.2	11.96	
111.2	78.4	8.88	95.7	11.43	109.4	14.02	111.2	13.19	113.1	12.65	116.2	12.46	119.9	12.58	
116.6	74.0	11.82	92.5	15.21	105.8	14.72	107.2	13.39	109.0	13.46	112.3	13.38	116.0	13.51	
122.0	67.8	11.60	82.9	14.93	94.4	15.52	95.6	14.50	97.2	14.37	100.2	14.30	104.2	14.12	
125.6	51.3	9.79	61.6	12.60	70.7	13.22	72.1	13.19	74.3	12.96	79.9	12.77	84.7	12.37	

GMV5 DC Inverter VRF Units Technical Sales Guide

Combination	Outdoor air temp (°FDB)	Indoor air temp													
		57.2°FWB		60.8°FWB		64.4°FWB		66.2°FWB		68°FWB		71.6°FWB		75.2°FWB	
		68°FDB		73.4°FDB		78.8°FDB		80.6°FDB		82.4°FDB		86°FDB		89.6°FDB	
		TC	PI	TC	PI	TC	PI	TC	PI	TC	PI	TC	PI	TC	PI
	kBtu/h	kW	kBtu/h	kW	kBtu/h	kW	kBtu/h	kW	kBtu/h	kW	kBtu/h	kW	kBtu/h	kW	
100%	23.0	81.0	3.04	96.4	3.90	112.3	4.86	120.0	5.37	127.7	5.40	143.6	5.45	151.6	5.49
	32.0	81.0	3.05	96.4	3.90	112.3	4.87	120.0	5.38	127.7	5.41	143.6	5.46	151.6	5.50
	39.2	81.0	3.06	96.4	3.92	112.3	4.89	120.0	5.40	127.7	5.43	143.6	5.48	151.6	5.53
	44.6	81.0	3.12	96.4	3.99	112.3	4.98	120.0	5.50	127.7	5.53	143.6	5.58	151.6	5.63
	50.0	81.0	3.45	96.4	4.19	112.3	4.96	120.0	5.35	127.7	5.78	143.5	6.54	151.7	6.80
	53.6	81.0	3.50	96.4	4.25	112.3	5.02	120.0	5.42	127.7	5.89	143.5	6.66	149.5	6.75
	57.2	81.0	3.56	96.4	4.32	112.3	5.11	120.0	5.52	127.7	6.00	143.5	6.77	147.8	6.69
	60.8	81.0	3.64	96.4	4.42	112.3	5.22	120.0	5.65	127.7	6.14	143.0	6.92	145.7	6.84
	64.4	81.0	3.72	96.4	4.52	112.3	5.33	120.0	5.76	127.7	6.25	141.0	7.06	144.0	7.16
	68.0	81.0	3.77	96.4	4.59	112.3	5.50	120.0	6.06	127.7	6.65	138.8	7.43	141.8	7.54
	69.8	81.0	3.81	96.4	4.63	112.3	5.69	120.0	6.27	127.7	6.88	138.0	7.68	141.0	7.75
	73.4	81.0	3.91	96.4	4.95	112.3	6.12	120.0	6.74	127.7	7.40	136.3	8.13	138.8	8.20
	77.0	81.0	4.16	96.4	5.26	112.3	6.51	120.0	7.17	127.7	7.91	134.1	8.42	137.2	8.50
	80.6	81.0	4.44	96.4	5.62	112.3	6.98	120.0	7.69	127.7	8.49	132.0	8.72	135.0	8.80
	84.2	81.0	4.71	96.4	6.01	112.3	7.47	120.0	8.23	127.3	8.99	130.2	9.14	133.2	9.22
	87.8	81.0	5.01	96.4	6.40	112.3	7.96	120.0	8.86	125.7	9.36	127.2	9.51	131.1	9.60
	91.4	81.0	5.33	96.4	6.82	112.3	8.49	120.0	9.38	123.4	9.70	126.6	9.79	129.4	9.87
	95.0	81.0	5.67	96.4	7.26	112.3	9.05	120.0	10.00	121.3	10.05	124.2	10.14	127.2	10.23
	98.6	81.0	6.04	96.4	7.73	112.3	9.64	117.9	10.36	119.8	10.41	122.4	10.49	125.4	10.58
	102.2	81.0	6.43	96.4	8.23	112.3	10.26	116.3	10.70	116.9	10.76	120.8	10.83	122.4	10.93
105.8	76.5	7.14	91.6	9.15	106.7	11.40	114.1	11.60	115.3	11.66	118.2	11.76	121.2	11.87	
111.2	71.3	7.77	86.8	9.94	101.6	12.67	109.2	13.10	110.7	12.56	113.8	12.37	117.0	12.48	
116.6	67.2	10.33	83.9	13.23	98.3	13.30	105.4	13.30	106.7	13.37	109.9	13.28	113.2	13.40	
122.0	61.6	10.15	75.2	12.99	87.7	14.03	94.0	14.40	95.2	14.27	98.1	14.20	101.8	14.02	
125.6	46.7	8.56	55.9	10.96	65.7	11.95	70.8	13.10	72.8	12.86	78.2	12.68	82.7	12.28	
90%	23.0	72.9	2.66	86.8	3.36	101.1	4.15	108.0	4.59	114.9	5.04	129.0	5.40	143.1	5.45
	32.0	72.9	2.66	86.8	3.37	101.1	4.16	108.0	4.59	114.9	5.05	129.0	5.41	143.1	5.46
	39.2	72.9	2.67	86.8	3.38	101.1	4.17	108.0	4.61	114.9	5.07	129.0	5.43	143.1	5.48
	44.6	72.9	2.72	86.8	3.44	101.1	4.25	108.0	4.70	114.9	5.17	129.0	5.53	143.1	5.58
	50.0	72.9	3.01	86.8	3.62	101.1	4.23	108.0	4.77	114.9	5.08	129.2	5.82	143.1	6.59
	53.6	72.9	3.05	86.8	3.66	101.1	4.29	108.0	4.83	114.9	5.18	129.2	5.92	143.1	6.68
	57.2	72.9	3.10	86.8	3.73	101.1	4.36	108.0	4.91	114.9	5.27	129.2	6.02	143.1	6.79
	60.8	72.9	3.17	86.8	3.81	101.1	4.46	108.0	5.02	114.9	5.38	129.2	6.16	142.7	6.92
	64.4	72.9	3.24	86.8	3.90	101.1	4.55	108.0	5.11	114.9	5.49	129.2	6.30	141.4	7.17
	68.0	72.9	3.29	86.8	3.96	101.1	4.70	108.0	5.22	114.9	5.72	129.2	6.77	138.9	7.47
	69.8	72.9	3.33	86.8	4.00	101.1	4.86	108.0	5.39	114.9	5.91	129.2	7.00	138.0	7.64
	73.4	72.9	3.41	86.8	4.27	101.1	5.22	108.0	5.80	114.9	6.33	129.2	7.52	135.9	8.03
	77.0	72.9	3.63	86.8	4.54	101.1	5.56	108.0	6.19	114.9	6.77	129.2	8.04	134.1	8.36
	80.6	72.9	3.88	86.8	4.85	101.1	5.96	108.0	6.60	114.9	7.25	129.2	8.58	132.0	8.72
	84.2	72.9	4.11	86.8	5.18	101.1	6.38	108.0	7.06	114.9	7.74	127.7	9.00	130.3	9.08
	87.8	72.9	4.37	86.8	5.52	101.1	6.80	108.0	7.53	114.9	8.26	125.6	9.32	128.1	9.44
	91.4	72.9	4.65	86.8	5.88	101.1	7.25	108.0	8.01	114.9	8.78	123.9	9.70	126.4	9.79
	95.0	72.9	4.95	86.8	6.26	101.1	7.73	108.0	8.54	114.9	9.39	121.7	10.05	124.3	10.14
	98.6	72.9	5.27	86.8	6.67	101.1	8.23	106.1	8.85	114.9	10.05	119.6	10.41	122.6	10.39
	102.2	72.9	5.61	86.8	7.10	101.1	8.77	104.6	9.14	114.9	10.65	117.9	10.80	120.4	10.77
105.8	68.9	6.23	82.4	7.89	96.0	9.74	102.7	9.91	109.3	10.90	115.9	11.66	118.4	11.76	
111.2	64.2	6.78	78.1	8.58	91.5	10.82	98.3	11.19	104.9	11.74	111.5	12.26	114.3	12.37	
116.6	60.5	9.02	75.5	11.41	88.4	11.36	94.8	11.36	101.1	12.49	107.7	13.17	110.6	13.29	
122.0	55.4	8.85	67.7	11.21	78.9	11.98	84.6	12.30	90.2	13.34	96.2	14.07	99.4	13.89	
125.6	42.0	7.47	50.3	9.45	59.1	10.20	63.7	11.19	69.0	12.02	76.7	12.56	80.8	12.17	

Combination	Outdoor air temp (°FDB)	Indoor air temp													
		57.2°FWB		60.8°FWB		64.4°FWB		66.2°FWB		68°FWB		71.6°FWB		75.2°FWB	
		68°FDB		73.4°FDB		78.8°FDB		80.6°FDB		82.4°FDB		86°FDB		89.6°FDB	
		TC	PI	TC	PI	TC	PI	TC	PI	TC	PI	TC	PI	TC	PI
		kBtu/h	kW	kBtu/h	kW	kBtu/h	kW	kBtu/h	kW	kBtu/h	kW	kBtu/h	kW	kBtu/h	kW
80%	23.0	64.8	2.29	77.1	2.83	89.8	3.52	96.0	3.87	102.0	4.23	114.9	5.02	127.3	5.38
	32.0	64.8	2.30	77.1	2.84	89.8	3.52	96.0	3.88	102.0	4.24	114.9	5.03	127.3	5.39
	39.2	64.8	2.31	77.1	2.85	89.8	3.54	96.0	3.89	102.0	4.26	114.9	5.05	127.3	5.41
	44.6	64.8	2.35	77.1	2.90	89.8	3.60	96.0	3.97	102.0	4.33	114.9	5.14	127.3	5.51
	50.0	64.8	2.74	77.1	3.27	89.8	3.85	96.0	4.15	102.2	4.44	114.8	5.08	127.3	5.90
	53.6	64.8	2.78	77.1	3.33	89.8	3.92	96.0	4.23	102.2	4.53	114.8	5.17	127.3	5.85
	57.2	64.8	2.83	77.1	3.40	89.8	3.99	96.0	4.30	102.2	4.61	114.8	5.26	127.3	5.98
	60.8	64.8	2.87	77.1	3.45	89.8	4.07	96.0	4.38	102.2	4.68	114.8	5.37	127.3	6.20
	64.4	64.8	2.92	77.1	3.52	89.8	4.16	96.0	4.47	102.2	4.77	114.8	5.49	127.3	6.63
	68.0	64.8	2.98	77.1	3.58	89.8	4.23	96.0	4.56	102.2	4.88	114.8	5.69	127.3	6.87
	69.8	64.8	3.01	77.1	3.61	89.8	4.27	96.0	4.61	102.2	4.99	114.8	5.90	127.3	7.36
	73.4	64.8	3.06	77.1	3.69	89.8	4.47	96.0	4.91	102.2	5.34	114.8	6.31	127.3	7.87
	77.0	64.8	3.15	77.1	3.92	89.8	4.78	96.0	5.24	102.2	5.70	114.8	6.76	127.3	8.40
	80.6	64.8	3.36	77.1	4.18	89.8	5.09	96.0	5.59	102.2	6.11	114.8	7.21	127.3	8.69
	84.2	64.8	3.57	77.1	4.45	89.8	5.43	96.0	5.96	101.8	6.52	114.8	7.70	127.3	9.01
	87.8	64.8	3.79	77.1	4.73	89.8	5.78	96.0	6.35	101.8	6.95	114.8	8.21	125.1	9.33
	91.4	64.8	4.03	77.1	5.27	89.8	6.16	96.0	6.76	101.8	7.40	114.8	8.76	123.4	9.67
	95.0	64.8	4.27	77.1	5.27	89.8	6.55	96.0	7.21	101.8	7.88	114.8	9.35	121.3	10.02
	98.6	64.8	4.53	77.1	5.67	89.8	6.97	94.3	7.68	101.8	8.39	114.8	9.96	119.6	10.39
	102.2	64.8	4.80	77.1	6.02	89.8	7.41	93.0	8.18	101.8	8.94	114.8	10.61	117.4	10.78
105.8	61.2	5.38	73.3	6.64	85.4	8.25	91.3	8.36	96.8	9.14	109.3	10.85	115.6	11.63	
111.2	57.0	5.85	69.4	7.22	81.3	9.17	87.4	9.45	93.0	9.85	105.2	11.41	111.6	12.23	
116.6	53.8	7.79	67.1	9.61	78.6	9.63	84.3	9.59	89.6	10.48	101.6	12.25	107.9	13.13	
122.0	49.2	7.65	60.2	9.43	70.2	10.15	75.2	10.38	79.9	11.19	90.7	13.10	97.0	13.73	
125.6	37.3	6.45	44.7	7.96	52.6	8.65	56.6	9.45	61.1	10.09	72.3	11.69	78.8	12.03	
70%	23.0	56.7	1.95	67.5	2.42	78.6	2.93	84.0	3.21	89.6	3.50	100.3	4.13	111.4	4.80
	32.0	56.7	1.96	67.5	2.42	78.6	2.94	84.0	3.22	89.6	3.51	100.3	4.13	111.4	4.81
	39.2	56.7	1.96	67.5	2.43	78.6	2.95	84.0	3.23	89.6	3.52	100.3	4.15	111.4	4.83
	44.6	56.7	2.00	67.5	2.48	78.6	3.00	84.0	3.29	89.6	3.59	100.3	4.23	111.4	4.91
	50.0	56.7	2.41	67.5	2.86	78.6	3.33	84.0	3.58	89.4	3.84	100.5	4.37	111.4	4.91
	53.6	56.7	2.44	67.5	2.90	78.6	3.40	84.0	3.65	89.4	3.91	100.5	4.45	111.4	5.00
	57.2	56.7	2.48	67.5	2.95	78.6	3.45	84.0	3.71	89.4	3.98	100.5	4.53	111.4	5.09
	60.8	56.7	2.52	67.5	3.01	78.6	3.52	84.0	3.79	89.4	4.06	100.5	4.61	111.4	5.19
	64.4	56.7	2.56	67.5	3.06	78.6	3.58	84.0	3.85	89.4	4.12	100.5	4.70	111.4	5.30
	68.0	56.7	2.60	67.5	3.11	78.6	3.65	84.0	3.92	89.4	4.20	100.5	4.80	111.4	5.44
	69.8	56.7	2.63	67.5	3.14	78.6	3.68	84.0	3.96	89.4	4.25	100.5	4.85	111.4	5.63
	73.4	56.7	2.67	67.5	3.19	78.6	3.76	84.0	4.10	89.4	4.46	100.5	5.22	111.4	6.04
	77.0	56.7	2.72	67.5	3.33	78.6	4.00	84.0	4.38	89.4	4.76	100.5	5.58	111.4	6.46
	80.6	56.7	2.88	67.5	3.54	78.6	4.27	84.0	4.66	89.4	5.08	100.5	5.96	111.4	6.90
	84.2	56.7	3.06	67.5	3.76	78.6	4.54	84.0	4.97	89.4	5.40	100.5	6.35	111.4	7.37
	87.8	56.7	3.23	67.5	3.99	78.6	4.84	84.0	5.28	89.4	5.75	100.5	6.77	111.4	7.86
	91.4	56.7	3.44	67.5	4.25	78.6	5.15	84.0	5.62	89.4	6.13	100.5	7.21	111.4	8.38
	95.0	56.7	3.64	67.5	4.50	78.6	5.46	84.0	5.98	89.4	6.52	100.5	7.68	111.4	8.94
	98.6	56.7	3.84	67.5	4.77	78.6	5.81	82.5	6.36	89.4	6.94	100.5	8.18	111.4	9.51
	102.2	56.7	4.07	67.5	5.05	78.6	6.16	81.4	6.75	89.4	7.37	100.5	8.69	111.4	10.13
105.8	53.6	4.58	64.1	5.67	74.7	6.88	79.8	6.94	85.0	7.57	95.6	8.91	106.2	10.36	
111.2	49.9	4.99	60.8	6.17	71.1	7.64	76.4	7.84	81.6	8.15	92.0	9.37	102.5	10.90	
116.6	47.1	6.63	58.7	8.21	68.8	8.02	73.8	7.96	78.7	8.68	88.9	10.06	99.2	11.71	
122.0	43.1	6.51	52.7	8.06	61.4	8.46	65.8	8.62	70.2	9.26	79.4	10.75	89.1	12.24	
125.6	32.7	5.49	39.2	6.80	46.0	7.20	49.6	7.84	53.6	8.35	63.3	9.60	72.4	10.72	

GMV5 DC Inverter VRF Units Technical Sales Guide

Combination	Outdoor air temp (°FDB)	Indoor air temp													
		57.2°FWB		60.8°FWB		64.4°FWB		66.2°FWB		68°FWB		71.6°FWB		75.2°FWB	
		68°FDB		73.4°FDB		78.8°FDB		80.6°FDB		82.4°FDB		86°FDB		89.6°FDB	
		TC	PI	TC	PI	TC	PI	TC	PI	TC	PI	TC	PI	TC	PI
		kBtu/h	kW	kBtu/h	kW	kBtu/h	kW	kBtu/h	kW	kBtu/h	kW	kBtu/h	kW	kBtu/h	kW
60%	23.0	48.6	1.64	57.9	2.00	67.4	2.40	72.0	2.62	76.7	2.84	86.1	3.32	95.6	3.84
	32.0	48.6	1.65	57.9	2.01	67.4	2.41	72.0	2.62	76.7	2.85	86.1	3.33	95.6	3.84
	39.2	48.6	1.65	57.9	2.02	67.4	2.42	72.0	2.63	76.7	2.86	86.1	3.34	95.6	3.86
	44.6	48.6	1.68	57.9	2.05	67.4	2.46	72.0	2.68	76.7	2.91	86.1	3.40	95.6	3.93
	50.0	48.6	2.09	57.9	2.45	67.4	2.84	72.0	3.05	76.6	3.25	86.1	3.68	95.6	4.12
	53.6	48.6	2.13	57.9	2.49	67.4	2.90	72.0	3.10	76.6	3.30	86.1	3.75	95.6	4.19
	57.2	48.6	2.16	57.9	2.53	67.4	2.94	72.0	3.15	76.6	3.37	86.1	3.81	95.6	4.27
	60.8	48.6	2.18	57.9	2.57	67.4	2.99	72.0	3.21	76.6	3.42	86.1	3.88	95.6	4.35
	64.4	48.6	2.22	57.9	2.61	67.4	3.05	72.0	3.26	76.6	3.49	86.1	3.95	95.6	4.43
	68.0	48.6	2.25	57.9	2.67	67.4	3.10	72.0	3.33	76.6	3.56	86.1	4.03	95.6	4.53
	69.8	48.6	2.28	57.9	2.68	67.4	3.13	72.0	3.36	76.6	3.58	86.1	4.07	95.6	4.57
	73.4	48.6	2.30	57.9	2.74	67.4	3.18	72.0	3.42	76.6	3.65	86.1	4.23	95.6	4.87
	77.0	48.6	2.35	57.9	2.79	67.4	3.30	72.0	3.58	76.6	3.88	86.1	4.51	95.6	5.19
	80.6	48.6	2.44	57.9	2.95	67.4	3.52	72.0	3.83	76.6	4.14	86.1	4.81	95.6	5.54
	84.2	48.6	2.57	57.9	3.13	67.4	3.75	72.0	4.07	76.6	4.41	86.1	5.13	95.6	5.92
	87.8	48.6	2.74	57.9	3.33	67.4	3.98	72.0	4.33	76.6	4.69	86.1	5.46	95.6	6.29
	91.4	48.6	2.88	57.9	3.52	67.4	4.22	72.0	4.60	76.6	4.99	86.1	5.81	95.6	6.71
	95.0	48.6	3.06	57.9	3.73	67.4	4.47	72.0	4.88	76.6	5.30	86.1	6.19	95.6	7.14
	98.6	48.6	3.23	57.9	3.95	67.4	4.74	70.7	5.18	76.6	5.62	86.1	6.58	95.6	7.60
	102.2	48.6	3.41	57.9	4.18	67.4	5.03	69.8	5.49	76.6	5.97	86.1	6.98	95.6	8.09
105.8	45.9	3.85	55.0	4.70	64.0	5.64	68.4	5.66	72.9	6.14	82.0	7.18	91.1	8.29	
111.2	42.8	4.19	52.1	5.11	61.0	6.26	65.5	6.39	70.0	6.62	78.9	7.55	87.9	8.71	
116.6	40.3	5.58	50.3	6.81	59.0	6.58	63.2	6.49	67.4	7.04	76.2	8.10	85.1	9.36	
122.0	36.9	5.48	45.1	6.68	52.6	6.94	56.4	7.03	60.1	7.52	68.0	8.66	76.5	9.79	
125.6	28.0	4.62	33.6	5.64	39.4	5.91	42.5	6.39	46.0	6.78	54.3	7.73	62.1	8.57	
50%	23.0	40.5	1.36	48.2	1.63	56.1	1.93	60.0	2.08	63.9	2.25	71.8	2.61	79.7	2.98
	32.0	40.5	1.36	48.2	1.63	56.1	1.93	60.0	2.09	63.9	2.25	71.8	2.61	79.7	2.99
	39.2	40.5	1.37	48.2	1.64	56.1	1.94	60.0	2.10	63.9	2.26	71.8	2.62	79.7	3.00
	44.6	40.5	1.39	48.2	1.67	56.1	1.97	60.0	2.13	63.9	2.31	71.8	2.67	79.7	3.05
	50.0	40.5	1.81	48.2	2.09	56.1	2.39	60.0	2.55	63.9	2.70	71.8	3.03	79.7	3.38
	53.6	40.5	1.82	48.2	2.12	56.1	2.43	60.0	2.57	63.9	2.75	71.8	3.09	79.7	3.44
	57.2	40.5	1.85	48.2	2.14	56.1	2.45	60.0	2.63	63.9	2.79	71.8	3.14	79.7	3.50
	60.8	40.5	1.87	48.2	2.17	56.1	2.49	60.0	2.67	63.9	2.83	71.8	3.19	79.7	3.56
	64.4	40.5	1.90	48.2	2.21	56.1	2.53	60.0	2.71	63.9	2.88	71.8	3.25	79.7	3.63
	68.0	40.5	1.93	48.2	2.24	56.1	2.57	60.0	2.76	63.9	2.94	71.8	3.32	79.7	3.69
	69.8	40.5	1.94	48.2	2.26	56.1	2.60	60.0	2.78	63.9	2.96	71.8	3.34	79.7	3.73
	73.4	40.5	1.97	48.2	2.29	56.1	2.64	60.0	2.83	63.9	3.02	71.8	3.40	79.7	3.81
	77.0	40.5	1.99	48.2	2.33	56.1	2.70	60.0	2.88	63.9	3.11	71.8	3.57	79.7	4.07
	80.6	40.5	2.04	48.2	2.43	56.1	2.84	60.0	3.07	63.9	3.30	71.8	3.80	79.7	4.34
	84.2	40.5	2.14	48.2	2.56	56.1	3.02	60.0	3.26	63.6	3.52	71.8	4.04	79.7	4.62
	87.8	40.5	2.26	48.2	2.71	56.1	3.22	60.0	3.46	63.6	3.73	71.8	4.30	79.7	4.92
	91.4	40.5	2.40	48.2	2.87	56.1	3.40	60.0	3.67	63.6	3.96	71.8	4.57	79.7	5.23
	95.0	40.5	2.53	48.2	3.03	56.1	3.58	60.0	3.88	63.6	4.19	71.8	4.85	79.7	5.55
	98.6	40.5	2.67	48.2	3.21	56.1	3.80	58.9	4.11	63.6	4.45	71.8	5.15	79.7	5.90
	102.2	40.5	2.82	48.2	3.38	56.1	4.02	58.1	4.35	63.6	4.72	71.8	5.46	79.7	6.27
105.8	38.3	3.19	45.8	3.82	53.3	4.52	57.0	4.50	60.5	4.86	68.3	5.63	76.0	6.44	
111.2	35.6	3.47	43.4	4.15	50.8	5.02	54.6	5.08	58.1	5.24	65.7	5.92	73.3	6.77	
116.6	33.6	4.62	41.9	5.53	49.1	5.27	52.7	5.16	56.0	5.57	63.5	6.36	70.9	7.27	
122.0	30.8	4.54	37.6	5.43	43.8	5.56	47.0	5.59	50.0	5.95	56.7	6.79	63.8	7.61	
125.6	23.3	3.83	28.0	4.58	32.8	4.73	35.4	5.08	38.2	5.36	45.2	6.06	51.8	6.66	

GMV-144WM/B1-F(U)

TC—Total capacity of outdoor unit; PI—Power input of outdoor unit

Combination	Outdoor air temp (°FDB)	Indoor air temp													
		57.2°FWB		60.8°FWB		64.4°FWB		66.2°FWB		68°FWB		71.6°FWB		75.2°FWB	
		68°FDB		73.4°FDB		78.8°FDB		80.6°FDB		82.4°FDB		86°FDB		89.6°FDB	
		TC	PI	TC	PI	TC	PI	TC	PI	TC	PI	TC	PI	TC	PI
		kBtu/h	kW	kBtu/h	kW	kBtu/h	kW	kBtu/h	kW	kBtu/h	kW	kBtu/h	kW	kBtu/h	kW
135%	23.0	126.5	5.31	150.7	6.46	174.9	6.54	181.5	6.57	184.8	6.61	189.6	6.69	194.3	6.76
	32.0	126.5	5.32	150.7	6.47	174.9	6.55	181.5	6.59	184.8	6.62	189.6	6.70	194.3	6.77
	39.2	126.5	5.34	150.7	6.50	174.9	6.58	181.5	6.61	184.8	6.65	189.6	6.72	194.3	6.79
	44.6	126.5	5.43	150.7	6.62	174.9	6.70	181.5	6.73	184.8	6.77	189.6	6.85	194.3	6.92
	50.0	126.5	5.53	150.7	6.76	174.9	8.04	181.5	8.22	183.6	8.05	188.2	7.71	192.9	7.36
	53.6	126.5	5.63	150.7	6.89	174.9	8.20	179.0	8.17	181.5	8.01	185.7	7.65	190.3	7.54
	57.2	126.5	5.74	150.7	7.02	174.3	8.30	176.9	8.13	179.0	7.96	183.6	7.89	188.2	7.97
	60.8	126.5	5.84	150.7	7.16	172.3	8.26	174.3	8.20	176.4	8.23	181.0	8.31	185.7	8.39
	64.4	126.5	5.95	150.7	7.31	169.7	8.57	171.8	8.62	174.3	8.67	179.0	8.75	183.6	8.83
	68.0	126.5	6.08	150.7	7.78	167.1	8.99	169.7	9.04	171.8	9.09	176.4	9.17	181.0	9.27
	69.8	126.5	6.24	150.7	8.05	166.1	9.20	168.7	9.25	170.7	9.30	175.4	9.40	180.0	9.48
	73.4	126.5	6.70	150.7	8.64	164.1	9.62	166.1	9.67	168.2	9.72	172.8	9.82	177.4	9.91
	77.0	126.5	7.15	150.7	9.25	161.5	10.04	164.1	10.09	166.1	10.16	170.7	10.25	175.4	10.35
	80.6	126.5	7.63	150.7	9.90	159.4	8.85	161.5	10.53	163.5	10.58	168.2	10.69	172.8	10.80
	84.2	126.5	8.15	150.7	10.58	156.9	10.88	158.9	10.95	161.5	11.01	166.1	11.13	170.7	11.24
	87.8	126.5	8.70	150.2	11.19	154.3	11.32	156.9	11.39	158.9	11.43	163.5	11.56	168.2	11.69
	91.4	126.5	9.27	147.6	11.61	152.2	11.73	154.3	11.81	156.9	11.87	161.5	12.00	165.6	12.15
	95.0	126.5	9.88	145.0	12.03	149.7	12.18	152.2	12.24	154.3	12.31	158.9	12.45	163.5	12.58
	98.6	126.5	10.51	143.0	12.47	147.6	12.61	149.7	12.68	152.2	12.76	156.3	12.91	161.0	13.05
	102.2	126.5	11.19	140.4	12.89	145.0	13.04	147.6	13.12	149.7	13.20	154.3	13.34	158.9	13.50
105.8	119.6	12.45	137.8	15.16	142.2	15.34	144.7	14.20	146.7	14.28	151.3	14.45	155.9	14.60	
111.2	111.3	13.54	130.5	16.48	135.4	17.05	138.5	16.04	140.9	15.38	145.6	15.19	150.5	15.35	
116.6	105.0	18.01	126.2	21.93	131.0	17.90	133.7	16.28	135.8	16.37	140.6	16.31	145.6	16.48	
122.0	96.2	17.69	113.1	21.54	116.9	18.88	119.2	17.63	121.1	17.48	125.5	17.43	130.8	17.24	
125.6	72.9	14.92	84.1	18.17	87.5	16.07	89.8	16.04	92.6	15.75	100.1	15.57	106.3	15.10	
120%	23.0	116.7	4.72	138.9	6.11	161.5	6.50	172.8	6.53	181.8	6.57	185.9	6.64	190.0	6.70
	32.0	116.7	4.73	138.9	6.13	161.5	6.51	172.8	6.54	181.8	6.58	185.9	6.65	190.0	6.72
	39.2	116.7	4.75	138.9	6.15	161.5	6.53	172.8	6.57	181.8	6.60	185.9	6.67	190.0	6.74
	44.6	116.7	4.84	138.9	6.26	161.5	6.65	172.8	6.69	181.8	6.72	185.9	6.80	190.0	6.87
	50.0	116.7	5.05	138.9	6.16	161.5	7.33	172.8	7.92	181.0	8.26	185.1	7.94	189.3	7.63
	53.6	116.7	5.14	138.9	6.27	161.5	7.47	172.8	8.07	178.5	8.22	182.6	7.91	186.7	7.58
	57.2	116.7	5.24	138.9	6.40	161.5	7.62	172.8	8.23	175.9	8.17	180.5	7.86	184.6	7.91
	60.8	116.7	5.34	138.9	6.53	161.5	7.76	171.8	8.30	173.8	8.18	177.9	8.26	182.1	8.33
	64.4	116.7	5.43	138.9	6.66	161.5	8.04	169.2	8.57	171.3	8.60	175.4	8.68	180.0	8.77
	68.0	116.7	5.55	138.9	6.92	161.5	8.64	167.1	8.99	169.2	9.02	173.3	9.11	177.4	9.19
	69.8	116.7	5.60	138.9	7.16	161.5	8.94	165.6	9.20	167.7	9.23	172.3	9.32	176.4	9.41
	73.4	116.7	5.98	138.9	7.68	161.5	9.57	163.5	9.61	165.6	9.65	169.7	9.75	173.8	9.83
	77.0	116.7	6.39	138.9	8.22	158.9	9.99	161.0	10.03	163.0	10.08	167.7	10.17	171.8	10.27
	80.6	116.7	6.82	138.9	8.78	156.9	10.40	158.9	10.46	161.0	10.51	165.1	10.61	169.2	10.71
	84.2	116.7	7.28	138.9	9.38	154.3	10.82	156.3	10.88	158.4	10.93	162.5	11.05	167.1	11.14
	87.8	116.7	7.76	138.9	10.01	152.2	11.26	154.3	11.30	156.3	11.37	160.5	11.48	164.6	11.60
	91.4	116.7	8.26	138.9	10.69	149.7	11.68	151.7	11.74	153.8	11.79	157.9	11.92	162.0	12.03
	95.0	116.7	8.80	138.9	11.39	147.1	12.10	149.1	12.16	151.7	12.23	155.8	12.36	159.9	12.49
	98.6	116.7	9.36	138.9	12.13	145.0	12.53	147.1	12.60	149.1	12.66	153.3	12.79	157.4	12.94
	102.2	116.7	9.96	138.3	12.81	142.5	12.95	144.5	13.04	146.6	13.10	151.2	13.25	155.3	13.37
105.8	110.3	11.09	131.9	14.35	139.8	15.24	141.8	14.11	144.3	14.18	148.3	14.33	152.4	14.48	
111.2	102.7	12.05	125.0	15.60	133.1	16.94	135.7	15.93	138.5	15.28	142.7	15.07	147.1	15.23	
116.6	96.9	16.04	120.8	20.76	128.7	17.78	130.9	16.18	133.5	16.26	137.9	16.19	142.3	16.36	
122.0	88.7	15.75	108.3	20.38	114.9	18.75	116.8	17.51	119.1	17.36	123.1	17.30	128.0	17.10	
125.6	67.2	13.28	80.5	17.19	86.0	15.97	88.0	15.93	91.0	15.65	98.2	15.44	104.0	14.98	

GMV5 DC Inverter VRF Units Technical Sales Guide

Combination	Outdoor air temp (°FDB)	Indoor air temp													
		57.2°FWB		60.8°FWB		64.4°FWB		66.2°FWB		68°FWB		71.6°FWB		75.2°FWB	
		68°FDB		73.4°FDB		78.8°FDB		80.6°FDB		82.4°FDB		86°FDB		89.6°FDB	
		TC	PI	TC	PI	TC	PI	TC	PI	TC	PI	TC	PI	TC	PI
	kBtu/h	kW	kBtu/h	kW	kBtu/h	kW	kBtu/h	kW	kBtu/h	kW	kBtu/h	kW	kBtu/h	kW	
110%	23.0	107.0	4.18	127.5	5.38	148.1	6.45	158.4	6.49	168.7	6.52	181.8	6.58	185.6	6.64
	32.0	107.0	4.19	127.5	5.39	148.1	6.46	158.4	6.50	168.7	6.53	181.8	6.60	185.6	6.66
	39.2	107.0	4.20	127.5	5.41	148.1	6.49	158.4	6.52	168.7	6.56	181.8	6.62	185.6	6.68
	44.6	107.0	4.28	127.5	5.51	148.1	6.61	158.4	6.64	168.7	6.68	181.8	6.74	185.6	6.80
	50.0	107.0	4.58	127.5	5.58	148.1	6.63	158.4	7.16	168.7	7.71	181.5	8.18	185.7	7.91
	53.6	107.0	4.67	127.5	5.69	148.1	6.76	158.4	7.31	168.7	7.86	179.5	8.15	183.1	7.86
	57.2	107.0	4.75	127.5	5.79	148.1	6.89	158.4	7.44	168.7	8.01	176.9	8.15	181.0	7.84
	60.8	107.0	4.84	127.5	5.90	148.1	7.02	158.4	7.58	168.7	8.17	174.9	8.20	178.5	8.28
	64.4	107.0	4.93	127.5	6.02	148.1	7.16	158.4	7.80	168.7	8.56	172.3	8.62	176.4	8.70
	68.0	107.0	5.03	127.5	6.15	148.1	7.58	158.4	8.38	166.1	8.98	170.2	9.04	173.8	9.12
	69.8	107.0	5.08	127.5	6.32	148.1	7.86	158.4	8.68	165.1	9.19	168.7	9.25	172.8	9.33
	73.4	107.0	5.32	127.5	6.78	148.1	8.43	158.4	9.32	162.5	9.59	166.6	9.69	170.2	9.77
	77.0	107.0	5.66	127.5	7.25	148.1	9.01	158.4	9.98	160.5	10.01	164.1	10.11	168.2	10.19
	80.6	107.0	6.05	127.5	7.75	148.1	9.64	155.8	10.40	157.9	10.43	162.0	10.53	165.6	10.63
	84.2	107.0	6.45	127.5	8.26	148.1	10.30	153.8	10.82	155.8	10.87	159.4	10.96	163.5	11.06
	87.8	107.0	6.87	127.5	8.81	148.1	11.00	151.2	11.24	153.3	11.29	157.4	11.39	161.0	11.50
	91.4	107.0	7.31	127.5	9.40	147.1	11.60	149.1	11.66	151.2	11.71	154.8	11.82	158.9	11.94
	95.0	107.0	7.78	127.5	10.01	145.0	12.02	146.6	12.08	148.6	12.15	152.2	12.26	156.3	12.37
	98.6	107.0	8.28	127.5	10.66	142.5	12.45	144.5	12.50	146.1	12.57	150.2	12.70	153.8	12.81
	102.2	107.0	8.80	127.5	11.35	139.9	12.87	141.9	12.94	144.0	13.00	147.6	13.13	151.7	13.26
105.8	101.1	9.80	121.2	12.61	137.8	15.14	139.3	14.01	141.3	14.09	144.9	14.22	149.0	14.35	
111.2	94.1	10.66	114.8	13.71	131.3	16.82	133.4	15.83	135.7	15.18	139.4	14.96	143.8	15.09	
116.6	88.8	14.18	111.0	18.25	126.9	17.66	128.7	16.07	130.8	16.15	134.7	16.06	139.1	16.21	
122.0	81.3	13.92	99.5	17.92	113.3	18.63	114.8	17.40	116.7	17.25	120.3	17.16	125.1	16.95	
125.6	61.6	11.75	74.0	15.12	84.8	15.86	86.5	15.83	89.2	15.55	95.9	15.32	101.6	14.85	
100%	23.0	97.2	3.65	115.7	4.68	134.7	5.83	144.0	6.44	153.3	6.48	172.3	6.53	181.9	6.59
	32.0	97.2	3.66	115.7	4.69	134.7	5.84	144.0	6.46	153.3	6.49	172.3	6.55	181.9	6.61
	39.2	97.2	3.67	115.7	4.70	134.7	5.86	144.0	6.48	153.3	6.51	172.3	6.57	181.9	6.63
	44.6	97.2	3.74	115.7	4.79	134.7	5.97	144.0	6.60	153.3	6.63	172.3	6.69	181.9	6.75
	50.0	97.2	4.14	115.7	5.03	134.7	5.95	144.0	6.42	153.2	6.94	172.2	7.85	182.0	8.16
	53.6	97.2	4.19	115.7	5.10	134.7	6.03	144.0	6.51	153.2	7.07	172.2	7.99	179.5	8.09
	57.2	97.2	4.27	115.7	5.18	134.7	6.13	144.0	6.63	153.2	7.20	172.2	8.12	177.4	8.03
	60.8	97.2	4.36	115.7	5.30	134.7	6.27	144.0	6.78	153.2	7.36	171.6	8.31	174.8	8.21
	64.4	97.2	4.46	115.7	5.42	134.7	6.39	144.0	6.91	153.2	7.51	169.2	8.47	172.8	8.60
	68.0	97.2	4.53	115.7	5.50	134.7	6.60	144.0	7.27	153.2	7.98	166.6	8.91	170.2	9.05
	69.8	97.2	4.58	115.7	5.56	134.7	6.83	144.0	7.52	153.2	8.26	165.6	9.22	169.2	9.30
	73.4	97.2	4.69	115.7	5.94	134.7	7.34	144.0	8.09	153.2	8.88	163.6	9.75	166.6	9.84
	77.0	97.2	4.99	115.7	6.32	134.7	7.81	144.0	8.60	153.2	9.50	161.0	10.11	164.6	10.20
	80.6	97.2	5.33	115.7	6.75	134.7	8.38	144.0	9.23	153.2	10.19	158.4	10.46	162.0	10.56
	84.2	97.2	5.65	115.7	7.21	134.7	8.96	144.0	9.87	152.7	10.79	156.2	10.97	159.8	11.07
	87.8	97.2	6.01	115.7	7.68	134.7	9.56	144.0	10.64	150.8	11.23	152.6	11.41	157.4	11.52
	91.4	97.2	6.39	115.7	8.18	134.7	10.19	144.0	11.26	148.1	11.64	151.9	11.74	155.2	11.85
	95.0	97.2	6.80	115.7	8.71	134.7	10.86	144.0	12.00	145.5	12.06	149.0	12.17	152.6	12.28
	98.6	97.2	7.24	115.7	9.28	134.7	11.57	141.4	12.43	143.7	12.49	146.9	12.58	150.5	12.70
	102.2	97.2	7.72	115.7	9.88	134.7	12.32	139.5	12.84	140.3	12.91	145.0	13.00	146.9	13.11
105.8	91.9	8.57	109.9	10.97	128.0	13.68	136.9	13.92	138.4	13.99	141.9	14.12	145.5	14.24	
111.2	85.5	9.32	104.1	11.93	121.9	15.20	131.0	15.72	132.9	15.07	136.5	14.85	140.4	14.98	
116.6	80.7	12.40	100.7	15.88	117.9	15.96	126.4	15.96	128.1	16.04	131.9	15.94	135.9	16.08	
122.0	73.9	12.18	90.3	15.59	105.2	16.83	112.8	17.28	114.2	17.13	117.7	17.04	122.1	16.82	
125.6	56.0	10.27	67.1	13.15	78.8	14.34	85.0	15.72	87.3	15.44	93.9	15.21	99.2	14.73	

Combination	Outdoor air temp (°FDB)	Indoor air temp													
		57.2°FWB		60.8°FWB		64.4°FWB		66.2°FWB		68°FWB		71.6°FWB		75.2°FWB	
		68°FDB		73.4°FDB		78.8°FDB		80.6°FDB		82.4°FDB		86°FDB		89.6°FDB	
		TC	PI	TC	PI	TC	PI	TC	PI	TC	PI	TC	PI	TC	PI
		kBtu/h	kW	kBtu/h	kW	kBtu/h	kW	kBtu/h	kW	kBtu/h	kW	kBtu/h	kW	kBtu/h	kW
90%	23.0	87.5	3.19	104.1	4.03	121.3	4.98	129.6	5.50	137.8	6.05	154.8	6.48	171.8	6.54
	32.0	87.5	3.19	104.1	4.04	121.3	4.99	129.6	5.51	137.8	6.06	154.8	6.49	171.8	6.55
	39.2	87.5	3.20	104.1	4.06	121.3	5.01	129.6	5.53	137.8	6.09	154.8	6.51	171.8	6.57
	44.6	87.5	3.26	104.1	4.13	121.3	5.10	129.6	5.64	137.8	6.20	154.8	6.63	171.8	6.69
	50.0	87.5	3.61	104.1	4.34	121.3	5.08	129.6	5.72	137.9	6.09	155.0	6.98	171.7	7.91
	53.6	87.5	3.66	104.1	4.40	121.3	5.15	129.6	5.80	137.9	6.21	155.0	7.10	171.7	8.01
	57.2	87.5	3.72	104.1	4.47	121.3	5.24	129.6	5.89	137.9	6.32	155.0	7.23	171.7	8.14
	60.8	87.5	3.81	104.1	4.57	121.3	5.35	129.6	6.02	137.9	6.46	155.0	7.39	171.2	8.30
	64.4	87.5	3.89	104.1	4.68	121.3	5.46	129.6	6.14	137.9	6.59	155.0	7.56	169.7	8.60
	68.0	87.5	3.95	104.1	4.75	121.3	5.64	129.6	6.26	137.9	6.86	155.0	8.12	166.6	8.96
	69.8	87.5	3.99	104.1	4.79	121.3	5.83	129.6	6.47	137.9	7.10	155.0	8.40	165.6	9.16
	73.4	87.5	4.09	104.1	5.12	121.3	6.27	129.6	6.96	137.9	7.60	155.0	9.02	163.0	9.64
	77.0	87.5	4.36	104.1	5.45	121.3	6.67	129.6	7.43	137.9	8.12	155.0	9.65	161.0	10.03
	80.6	87.5	4.65	104.1	5.82	121.3	7.16	129.6	7.92	137.9	8.70	155.0	10.30	158.4	10.47
	84.2	87.5	4.93	104.1	6.22	121.3	7.65	129.6	8.47	137.9	9.28	153.3	10.79	156.3	10.89
	87.8	87.5	5.24	104.1	6.62	121.3	8.16	129.6	9.04	137.9	9.91	150.7	11.19	153.8	11.33
	91.4	87.5	5.58	104.1	7.05	121.3	8.70	129.6	9.61	137.9	10.54	148.6	11.64	151.7	11.74
	95.0	87.5	5.93	104.1	7.51	121.3	9.27	129.6	10.25	137.9	11.27	146.1	12.06	149.1	12.17
	98.6	87.5	6.32	104.1	8.00	121.3	9.88	127.3	10.62	137.9	12.06	143.5	12.50	147.1	12.46
	102.2	87.5	6.73	104.1	8.52	121.3	10.52	125.6	10.97	137.9	12.79	141.4	12.96	144.5	12.92
105.8	82.7	7.48	98.9	9.47	115.2	11.69	123.2	11.89	131.2	13.08	139.0	13.99	142.1	14.12	
111.2	77.0	8.13	93.7	10.29	109.7	12.98	117.9	13.42	125.9	14.09	133.8	14.72	137.2	14.85	
116.6	72.6	10.82	90.6	13.69	106.1	13.63	113.8	13.63	121.4	14.99	129.3	15.80	132.7	15.94	
122.0	66.5	10.62	81.2	13.45	94.7	14.38	101.5	14.76	108.3	16.01	115.4	16.89	119.3	16.67	
125.6	50.4	8.96	60.4	11.34	70.9	12.24	76.5	13.42	82.8	14.43	92.0	15.08	96.9	14.60	
80%	23.0	77.8	2.75	92.6	3.40	107.8	4.22	115.2	4.65	122.4	5.08	137.8	6.03	152.7	6.46
	32.0	77.8	2.76	92.6	3.40	107.8	4.23	115.2	4.65	122.4	5.09	137.8	6.04	152.7	6.47
	39.2	77.8	2.77	92.6	3.41	107.8	4.24	115.2	4.67	122.4	5.11	137.8	6.06	152.7	6.49
	44.6	77.8	2.82	92.6	3.48	107.8	4.32	115.2	4.76	122.4	5.20	137.8	6.17	152.7	6.61
	50.0	77.8	3.28	92.6	3.93	107.8	4.63	115.2	4.98	122.6	5.33	137.8	6.09	152.7	7.08
	53.6	77.8	3.33	92.6	3.99	107.8	4.71	115.2	5.08	122.6	5.44	137.8	6.20	152.7	7.02
	57.2	77.8	3.40	92.6	4.08	107.8	4.79	115.2	5.16	122.6	5.54	137.8	6.31	152.7	7.18
	60.8	77.8	3.44	92.6	4.14	107.8	4.88	115.2	5.26	122.6	5.62	137.8	6.45	152.7	7.44
	64.4	77.8	3.51	92.6	4.22	107.8	4.99	115.2	5.37	122.6	5.73	137.8	6.59	152.7	7.96
	68.0	77.8	3.57	92.6	4.30	107.8	5.08	115.2	5.47	122.6	5.86	137.8	6.83	152.7	8.24
	69.8	77.8	3.61	92.6	4.33	107.8	5.13	115.2	5.53	122.6	5.99	137.8	7.08	152.7	8.83
	73.4	77.8	3.67	92.6	4.43	107.8	5.37	115.2	5.89	122.6	6.41	137.8	7.57	152.7	9.44
	77.0	77.8	3.78	92.6	4.71	107.8	5.74	115.2	6.29	122.6	6.84	137.8	8.11	152.7	10.07
	80.6	77.8	4.03	92.6	5.01	107.8	6.11	115.2	6.71	122.6	7.34	137.8	8.65	152.7	10.43
	84.2	77.8	4.29	92.6	5.34	107.8	6.52	115.2	7.15	122.2	7.82	137.8	9.23	152.7	10.81
	87.8	77.8	4.54	92.6	5.68	107.8	6.94	115.2	7.62	122.2	8.34	137.8	9.86	150.2	11.20
	91.4	77.8	4.84	92.6	6.32	107.8	7.39	115.2	8.12	122.2	8.88	137.8	10.52	148.1	11.61
	95.0	77.8	5.13	92.6	6.32	107.8	7.86	115.2	8.65	122.2	9.46	137.8	11.23	145.5	12.03
	98.6	77.8	5.43	92.6	6.81	107.8	8.36	113.1	9.21	122.2	10.07	137.8	11.95	143.5	12.47
	102.2	77.8	5.76	92.6	7.23	107.8	8.89	111.6	9.81	122.2	10.73	137.8	12.73	140.9	12.93
105.8	73.5	6.46	87.9	7.97	102.4	9.90	109.5	10.04	116.2	10.97	131.2	13.02	138.7	13.95	
111.2	68.4	7.02	83.3	8.66	97.6	11.00	104.8	11.33	111.6	11.82	126.2	13.69	133.9	14.67	
116.6	64.5	9.35	80.5	11.53	94.3	11.55	101.1	11.51	107.5	12.58	121.9	14.70	129.5	15.75	
122.0	59.1	9.18	72.2	11.32	84.2	12.18	90.2	12.46	95.9	13.43	108.8	15.72	116.4	16.48	
125.6	44.8	7.74	53.7	9.55	63.1	10.37	68.0	11.33	73.3	12.10	86.8	14.03	94.6	14.43	

GMV5 DC Inverter VRF Units Technical Sales Guide

Combination	Outdoor air temp (°FDB)	Indoor air temp													
		57.2°FWB		60.8°FWB		64.4°FWB		66.2°FWB		68°FWB		71.6°FWB		75.2°FWB	
		68°FDB		73.4°FDB		78.8°FDB		80.6°FDB		82.4°FDB		86°FDB		89.6°FDB	
		TC	PI	TC	PI	TC	PI	TC	PI	TC	PI	TC	PI	TC	PI
		kBtu/h	kW	kBtu/h	kW	kBtu/h	kW	kBtu/h	kW	kBtu/h	kW	kBtu/h	kW	kBtu/h	kW
70%	23.0	68.0	2.34	81.0	2.90	94.3	3.52	100.8	3.86	107.5	4.20	120.3	4.95	133.7	5.76
	32.0	68.0	2.35	81.0	2.91	94.3	3.52	100.8	3.86	107.5	4.21	120.3	4.96	133.7	5.77
	39.2	68.0	2.36	81.0	2.92	94.3	3.54	100.8	3.88	107.5	4.23	120.3	4.98	133.7	5.79
	44.6	68.0	2.40	81.0	2.97	94.3	3.60	100.8	3.95	107.5	4.31	120.3	5.07	133.7	5.90
	50.0	68.0	2.89	81.0	3.43	94.3	3.99	100.8	4.30	107.3	4.61	120.6	5.24	133.7	5.89
	53.6	68.0	2.93	81.0	3.48	94.3	4.08	100.8	4.38	107.3	4.69	120.6	5.34	133.7	6.00
	57.2	68.0	2.98	81.0	3.54	94.3	4.14	100.8	4.45	107.3	4.77	120.6	5.43	133.7	6.11
	60.8	68.0	3.02	81.0	3.61	94.3	4.22	100.8	4.54	107.3	4.87	120.6	5.53	133.7	6.23
	64.4	68.0	3.07	81.0	3.67	94.3	4.30	100.8	4.63	107.3	4.95	120.6	5.64	133.7	6.36
	68.0	68.0	3.12	81.0	3.74	94.3	4.38	100.8	4.71	107.3	5.05	120.6	5.76	133.7	6.53
	69.8	68.0	3.15	81.0	3.77	94.3	4.42	100.8	4.75	107.3	5.09	120.6	5.82	133.7	6.76
	73.4	68.0	3.20	81.0	3.83	94.3	4.51	100.8	4.92	107.3	5.35	120.6	6.26	133.7	7.25
	77.0	68.0	3.27	81.0	3.99	94.3	4.80	100.8	5.26	107.3	5.71	120.6	6.70	133.7	7.75
	80.6	68.0	3.46	81.0	4.25	94.3	5.13	100.8	5.60	107.3	6.10	120.6	7.15	133.7	8.28
	84.2	68.0	3.67	81.0	4.51	94.3	5.45	100.8	5.97	107.3	6.49	120.6	7.62	133.7	8.85
	87.8	68.0	3.88	81.0	4.79	94.3	5.81	100.8	6.34	107.3	6.91	120.6	8.12	133.7	9.43
	91.4	68.0	4.12	81.0	5.09	94.3	6.18	100.8	6.74	107.3	7.36	120.6	8.65	133.7	10.06
	95.0	68.0	4.37	81.0	5.40	94.3	6.55	100.8	7.18	107.3	7.83	120.6	9.22	133.7	10.72
	98.6	68.0	4.61	81.0	5.73	94.3	6.97	99.0	7.63	107.3	8.33	120.6	9.82	133.7	11.42
	102.2	68.0	4.88	81.0	6.06	94.3	7.39	97.7	8.10	107.3	8.85	120.6	10.43	133.7	12.16
105.8	64.3	5.50	77.0	6.81	89.6	8.25	95.8	8.33	102.0	9.08	114.8	10.69	127.4	12.44	
111.2	59.9	5.98	72.9	7.40	85.4	9.17	91.7	9.41	97.9	9.78	110.4	11.25	123.0	13.08	
116.6	56.5	7.96	70.5	9.85	82.5	9.63	88.5	9.55	94.4	10.41	106.7	12.08	119.0	14.05	
122.0	51.7	7.82	63.2	9.67	73.7	10.15	78.9	10.34	84.2	11.12	95.2	12.91	107.0	14.69	
125.6	39.2	6.59	47.0	8.16	55.2	8.65	59.5	9.41	64.4	10.02	76.0	11.52	86.9	12.87	
60%	23.0	58.3	1.97	69.4	2.41	80.8	2.88	86.4	3.14	92.1	3.41	103.4	3.99	114.7	4.60
	32.0	58.3	1.98	69.4	2.41	80.8	2.89	86.4	3.15	92.1	3.42	103.4	3.99	114.7	4.61
	39.2	58.3	1.98	69.4	2.42	80.8	2.90	86.4	3.16	92.1	3.43	103.4	4.01	114.7	4.63
	44.6	58.3	2.02	69.4	2.46	80.8	2.95	86.4	3.22	92.1	3.50	103.4	4.08	114.7	4.71
	50.0	58.3	2.51	69.4	2.94	80.8	3.41	86.4	3.65	91.9	3.90	103.3	4.42	114.7	4.95
	53.6	58.3	2.56	69.4	2.99	80.8	3.48	86.4	3.72	91.9	3.96	103.3	4.50	114.7	5.03
	57.2	58.3	2.59	69.4	3.04	80.8	3.53	86.4	3.78	91.9	4.04	103.3	4.58	114.7	5.13
	60.8	58.3	2.62	69.4	3.09	80.8	3.59	86.4	3.85	91.9	4.11	103.3	4.66	114.7	5.22
	64.4	58.3	2.67	69.4	3.14	80.8	3.65	86.4	3.91	91.9	4.19	103.3	4.74	114.7	5.32
	68.0	58.3	2.70	69.4	3.20	80.8	3.72	86.4	3.99	91.9	4.27	103.3	4.84	114.7	5.43
	69.8	58.3	2.73	69.4	3.22	80.8	3.75	86.4	4.03	91.9	4.30	103.3	4.88	114.7	5.48
	73.4	58.3	2.77	69.4	3.28	80.8	3.82	86.4	4.11	91.9	4.38	103.3	5.08	114.7	5.84
	77.0	58.3	2.81	69.4	3.35	80.8	3.96	86.4	4.30	91.9	4.66	103.3	5.42	114.7	6.23
	80.6	58.3	2.93	69.4	3.54	80.8	4.22	86.4	4.59	91.9	4.96	103.3	5.77	114.7	6.65
	84.2	58.3	3.09	69.4	3.75	80.8	4.50	86.4	4.88	91.9	5.29	103.3	6.16	114.7	7.10
	87.8	58.3	3.28	69.4	3.99	80.8	4.77	86.4	5.19	91.9	5.63	103.3	6.55	114.7	7.55
	91.4	58.3	3.46	69.4	4.22	80.8	5.06	86.4	5.51	91.9	5.98	103.3	6.97	114.7	8.05
	95.0	58.3	3.67	69.4	4.48	80.8	5.37	86.4	5.85	91.9	6.36	103.3	7.42	114.7	8.57
	98.6	58.3	3.88	69.4	4.74	80.8	5.69	84.9	6.21	91.9	6.74	103.3	7.89	114.7	9.12
	102.2	58.3	4.09	69.4	5.01	80.8	6.03	83.7	6.58	91.9	7.16	103.3	8.38	114.7	9.70
105.8	55.1	4.63	66.0	5.64	76.8	6.77	82.1	6.79	87.4	7.37	98.4	8.61	109.3	9.94	
111.2	51.3	5.03	62.5	6.14	73.2	7.52	78.6	7.67	83.9	7.94	94.7	9.06	105.5	10.46	
116.6	48.4	6.69	60.4	8.17	70.7	7.89	75.9	7.79	80.9	8.45	91.5	9.72	102.1	11.23	
122.0	44.3	6.57	54.2	8.02	63.1	8.32	67.7	8.43	72.2	9.03	81.6	10.39	91.7	11.74	
125.6	33.6	5.54	40.3	6.76	47.3	7.09	51.0	7.67	55.2	8.14	65.1	9.28	74.5	10.29	

Combination	Outdoor air temp (°FDB)	Indoor air temp													
		57.2°FWB		60.8°FWB		64.4°FWB		66.2°FWB		68°FWB		71.6°FWB		75.2°FWB	
		68°FDB		73.4°FDB		78.8°FDB		80.6°FDB		82.4°FDB		86°FDB		89.6°FDB	
		TC	PI	TC	PI	TC	PI	TC	PI	TC	PI	TC	PI	TC	PI
		kBtu/h	kW	kBtu/h	kW	kBtu/h	kW	kBtu/h	kW	kBtu/h	kW	kBtu/h	kW	kBtu/h	kW
50%	23.0	48.6	1.63	57.9	1.95	67.4	2.31	72.0	2.50	76.6	2.70	86.1	3.13	95.7	3.58
	32.0	48.6	1.64	57.9	1.96	67.4	2.31	72.0	2.51	76.6	2.71	86.1	3.13	95.7	3.58
	39.2	48.6	1.64	57.9	1.96	67.4	2.32	72.0	2.52	76.6	2.72	86.1	3.14	95.7	3.60
	44.6	48.6	1.67	57.9	2.00	67.4	2.37	72.0	2.56	76.6	2.77	86.1	3.20	95.7	3.66
	50.0	48.6	2.17	57.9	2.51	67.4	2.86	72.0	3.06	76.6	3.23	86.1	3.64	95.7	4.06
	53.6	48.6	2.18	57.9	2.54	67.4	2.91	72.0	3.09	76.6	3.30	86.1	3.70	95.7	4.12
	57.2	48.6	2.22	57.9	2.57	67.4	2.94	72.0	3.15	76.6	3.35	86.1	3.77	95.7	4.20
	60.8	48.6	2.25	57.9	2.60	67.4	2.99	72.0	3.20	76.6	3.40	86.1	3.83	95.7	4.27
	64.4	48.6	2.28	57.9	2.65	67.4	3.04	72.0	3.25	76.6	3.46	86.1	3.90	95.7	4.35
	68.0	48.6	2.31	57.9	2.68	67.4	3.09	72.0	3.32	76.6	3.53	86.1	3.98	95.7	4.43
	69.8	48.6	2.33	57.9	2.72	67.4	3.12	72.0	3.33	76.6	3.56	86.1	4.01	95.7	4.48
	73.4	48.6	2.36	57.9	2.75	67.4	3.17	72.0	3.40	76.6	3.62	86.1	4.08	95.7	4.58
	77.0	48.6	2.39	57.9	2.80	67.4	3.23	72.0	3.46	76.6	3.74	86.1	4.29	95.7	4.88
	80.6	48.6	2.44	57.9	2.91	67.4	3.41	72.0	3.69	76.6	3.96	86.1	4.56	95.7	5.21
	84.2	48.6	2.57	57.9	3.07	67.4	3.62	72.0	3.91	76.4	4.22	86.1	4.85	95.7	5.55
	87.8	48.6	2.72	57.9	3.25	67.4	3.87	72.0	4.16	76.4	4.48	86.1	5.16	95.7	5.90
	91.4	48.6	2.88	57.9	3.44	67.4	4.08	72.0	4.40	76.4	4.75	86.1	5.48	95.7	6.27
	95.0	48.6	3.04	57.9	3.64	67.4	4.30	72.0	4.66	76.4	5.03	86.1	5.82	95.7	6.66
	98.6	48.6	3.20	57.9	3.85	67.4	4.56	70.7	4.93	76.4	5.34	86.1	6.18	95.7	7.08
	102.2	48.6	3.38	57.9	4.06	67.4	4.82	69.8	5.22	76.4	5.66	86.1	6.55	95.7	7.52
105.8	45.9	3.83	55.0	4.58	64.0	5.42	68.4	5.40	72.6	5.83	82.0	6.75	91.2	7.73	
111.2	42.8	4.17	52.1	4.99	61.0	6.02	65.5	6.10	69.7	6.29	78.9	7.10	88.0	8.13	
116.6	40.3	5.54	50.3	6.63	58.9	6.32	63.2	6.19	67.2	6.69	76.2	7.63	85.1	8.73	
122.0	36.9	5.44	45.1	6.51	52.6	6.67	56.4	6.71	60.0	7.14	68.0	8.15	76.5	9.13	
125.6	28.0	4.59	33.6	5.49	39.4	5.68	42.5	6.10	45.8	6.44	54.3	7.28	62.2	8.00	

GMV-168WM/B1-F(U)

TC—Total capacity of outdoor unit; PI—Power input of outdoor unit

Combination	Outdoor air temp (°FDB)	Indoor air temp													
		57.2°FWB		60.8°FWB		64.4°FWB		66.2°FWB		68°FWB		71.6°FWB		75.2°FWB	
		68°FDB		73.4°FDB		78.8°FDB		80.6°FDB		82.4°FDB		86°FDB		89.6°FDB	
		TC	PI	TC	PI	TC	PI	TC	PI	TC	PI	TC	PI	TC	PI
		kBtu/h	kW	kBtu/h	kW	kBtu/h	kW	kBtu/h	kW	kBtu/h	kW	kBtu/h	kW	kBtu/h	kW
135%	23.0	147.6	6.19	175.8	7.54	204.0	7.63	211.8	7.67	215.6	7.71	221.2	7.80	226.7	7.88
	32.0	147.6	6.20	175.8	7.55	204.0	7.64	211.8	7.68	215.6	7.72	221.2	7.82	226.7	7.90
	39.2	147.6	6.23	175.8	7.58	204.0	7.67	211.8	7.71	215.6	7.75	221.2	7.85	226.7	7.93
	44.6	147.6	6.34	175.8	7.72	204.0	7.81	211.8	7.86	215.6	7.90	221.2	7.99	226.7	8.07
	50.0	147.6	6.45	175.8	7.89	204.0	9.38	211.8	9.58	214.2	9.40	219.6	9.00	225.0	8.58
	53.6	147.6	6.57	175.8	8.04	204.0	9.57	208.8	9.53	211.8	9.34	216.6	8.92	222.0	8.79
	57.2	147.6	6.70	175.8	8.19	203.4	9.68	206.4	9.49	208.8	9.28	214.2	9.21	219.6	9.30
	60.8	147.6	6.81	175.8	8.36	201.0	9.64	203.4	9.57	205.8	9.60	211.2	9.70	216.6	9.79
	64.4	147.6	6.94	175.8	8.53	198.0	10.00	200.4	10.06	203.4	10.11	208.8	10.21	214.2	10.30
	68.0	147.6	7.09	175.8	9.08	195.0	10.49	198.0	10.55	200.4	10.60	205.8	10.70	211.2	10.81
	69.8	147.6	7.28	175.8	9.40	193.8	10.74	196.8	10.79	199.2	10.85	204.6	10.96	210.0	11.06
	73.4	147.6	7.81	175.8	10.08	191.4	11.23	193.8	11.28	196.2	11.34	201.6	11.45	207.0	11.57
	77.0	147.6	8.34	175.8	10.79	188.4	11.72	191.4	11.77	193.8	11.85	199.2	11.96	204.6	12.08
	80.6	147.6	8.91	175.8	11.55	186.0	10.32	188.4	12.28	190.8	12.34	196.2	12.47	201.6	12.60
	84.2	147.6	9.51	175.8	12.34	183.0	12.70	185.4	12.77	188.4	12.85	193.8	12.98	199.2	13.11
	87.8	147.6	10.15	175.2	13.06	180.0	13.21	183.0	13.28	185.4	13.34	190.8	13.49	196.2	13.64
	91.4	147.6	10.81	172.2	13.55	177.6	13.68	180.0	13.77	183.0	13.85	188.4	14.00	193.2	14.17
	95.0	147.6	11.53	169.2	14.04	174.6	14.21	177.6	14.28	180.0	14.36	185.4	14.53	190.8	14.68
	98.6	147.6	12.26	166.8	14.55	172.2	14.72	174.6	14.79	177.6	14.89	182.4	15.06	187.8	15.23
	102.2	147.6	13.06	163.8	15.04	169.2	15.21	172.2	15.30	174.6	15.40	180.0	15.57	185.4	15.75
105.8	139.5	14.53	160.7	17.69	165.9	17.90	168.8	16.57	171.2	16.66	176.5	16.85	181.8	17.03	
111.2	129.9	15.79	152.3	19.23	158.0	19.89	161.6	18.71	164.3	17.95	169.8	17.72	175.5	17.91	
116.6	122.5	21.02	147.2	25.59	152.8	20.89	155.9	19.00	158.4	19.10	164.1	19.03	169.8	19.23	
122.0	112.2	20.64	132.0	25.13	136.4	22.02	139.1	20.57	141.3	20.39	146.5	20.34	152.6	20.11	
125.6	85.0	17.41	98.1	21.20	102.1	18.75	104.8	18.71	108.0	18.38	116.8	18.16	124.0	17.62	

GMV5 DC Inverter VRF Units Technical Sales Guide

Combination	Outdoor air temp (°FDB)	Indoor air temp													
		57.2°FWB		60.8°FWB		64.4°FWB		66.2°FWB		68°FWB		71.6°FWB		75.2°FWB	
		68°FDB		73.4°FDB		78.8°FDB		80.6°FDB		82.4°FDB		86°FDB		89.6°FDB	
		TC	PI	TC	PI	TC	PI	TC	PI	TC	PI	TC	PI	TC	PI
		kBtu/h	kW	kBtu/h	kW	kBtu/h	kW	kBtu/h	kW	kBtu/h	kW	kBtu/h	kW	kBtu/h	kW
120%	23.0	136.2	5.51	162.0	7.13	188.4	7.58	201.6	7.62	212.0	7.66	216.9	7.74	221.7	7.82
	32.0	136.2	5.52	162.0	7.15	188.4	7.59	201.6	7.63	212.0	7.67	216.9	7.76	221.7	7.84
	39.2	136.2	5.54	162.0	7.17	188.4	7.62	201.6	7.66	212.0	7.70	216.9	7.78	221.7	7.87
	44.6	136.2	5.65	162.0	7.31	188.4	7.76	201.6	7.80	212.0	7.85	216.9	7.93	221.7	8.01
	50.0	136.2	5.89	162.0	7.19	188.4	8.55	201.6	9.25	211.2	9.64	216.0	9.26	220.8	8.91
	53.6	136.2	6.00	162.0	7.32	188.4	8.72	201.6	9.42	208.2	9.58	213.0	9.23	217.8	8.85
	57.2	136.2	6.11	162.0	7.47	188.4	8.89	201.6	9.60	205.2	9.53	210.6	9.17	215.4	9.23
	60.8	136.2	6.23	162.0	7.62	188.4	9.06	200.4	9.68	202.8	9.55	207.6	9.64	212.4	9.72
	64.4	136.2	6.34	162.0	7.77	188.4	9.38	197.4	10.00	199.8	10.04	204.6	10.13	210.0	10.23
	68.0	136.2	6.47	162.0	8.08	188.4	10.08	195.0	10.49	197.4	10.53	202.2	10.62	207.0	10.72
	69.8	136.2	6.53	162.0	8.36	188.4	10.43	193.2	10.74	195.6	10.77	201.0	10.87	205.8	10.98
	73.4	136.2	6.98	162.0	8.96	188.4	11.17	190.8	11.21	193.2	11.26	198.0	11.38	202.8	11.47
	77.0	136.2	7.45	162.0	9.58	185.4	11.66	187.8	11.70	190.2	11.75	195.6	11.87	200.4	11.98
	80.6	136.2	7.96	162.0	10.25	183.0	12.13	185.4	12.21	187.8	12.26	192.6	12.38	197.4	12.49
	84.2	136.2	8.49	162.0	10.94	180.0	12.62	182.4	12.70	184.8	12.75	189.6	12.89	195.0	13.00
	87.8	136.2	9.06	162.0	11.68	177.6	13.13	180.0	13.19	182.4	13.26	187.2	13.40	192.0	13.53
	91.4	136.2	9.64	162.0	12.47	174.6	13.62	177.0	13.70	179.4	13.75	184.2	13.91	189.0	14.04
	95.0	136.2	10.26	162.0	13.28	171.6	14.11	174.0	14.19	177.0	14.26	181.8	14.42	186.6	14.57
	98.6	136.2	10.92	162.0	14.15	169.2	14.62	171.6	14.70	174.0	14.77	178.8	14.92	183.6	15.09
	102.2	136.2	11.62	161.4	14.94	166.2	15.11	168.6	15.21	171.0	15.28	176.4	15.45	181.2	15.60
105.8	128.7	12.93	153.9	16.74	163.1	17.78	165.4	16.46	168.3	16.55	173.1	16.72	177.8	16.90	
111.2	119.9	14.06	145.8	18.20	155.3	19.76	158.3	18.59	161.6	17.83	166.5	17.59	171.7	17.77	
116.6	113.0	18.71	140.9	24.21	150.2	20.75	152.8	18.87	155.8	18.97	160.9	18.88	166.1	19.08	
122.0	103.5	18.37	126.4	23.78	134.0	21.88	136.2	20.43	138.9	20.26	143.6	20.18	149.3	19.96	
125.6	78.5	15.50	94.0	20.06	100.4	18.63	102.7	18.59	106.2	18.26	114.5	18.02	121.3	17.48	
110%	23.0	124.8	4.87	148.8	6.27	172.8	7.53	184.8	7.57	196.8	7.61	212.1	7.68	216.5	7.75
	32.0	124.8	4.88	148.8	6.28	172.8	7.54	184.8	7.58	196.8	7.62	212.1	7.69	216.5	7.77
	39.2	124.8	4.90	148.8	6.31	172.8	7.57	184.8	7.61	196.8	7.65	212.1	7.72	216.5	7.79
	44.6	124.8	4.99	148.8	6.42	172.8	7.71	184.8	7.75	196.8	7.79	212.1	7.87	216.5	7.94
	50.0	124.8	5.34	148.8	6.51	172.8	7.74	184.8	8.36	196.8	9.00	211.8	9.55	216.6	9.23
	53.6	124.8	5.45	148.8	6.64	172.8	7.89	184.8	8.53	196.8	9.17	209.4	9.51	213.6	9.17
	57.2	124.8	5.55	148.8	6.75	172.8	8.04	184.8	8.68	196.8	9.34	206.4	9.51	211.2	9.15
	60.8	124.8	5.64	148.8	6.89	172.8	8.19	184.8	8.85	196.8	9.53	204.0	9.57	208.2	9.66
	64.4	124.8	5.75	148.8	7.02	172.8	8.36	184.8	9.09	196.8	9.98	201.0	10.06	205.8	10.15
	68.0	124.8	5.87	148.8	7.17	172.8	8.85	184.8	9.77	193.8	10.47	198.6	10.55	202.8	10.64
	69.8	124.8	5.92	148.8	7.38	172.8	9.17	184.8	10.13	192.6	10.72	196.8	10.79	201.6	10.89
	73.4	124.8	6.21	148.8	7.91	172.8	9.83	184.8	10.87	189.6	11.19	194.4	11.30	198.6	11.40
	77.0	124.8	6.60	148.8	8.45	172.8	10.51	184.8	11.64	187.2	11.68	191.4	11.79	196.2	11.89
	80.6	124.8	7.06	148.8	9.04	172.8	11.25	181.8	12.13	184.2	12.17	189.0	12.28	193.2	12.40
	84.2	124.8	7.53	148.8	9.64	172.8	12.02	179.4	12.62	181.8	12.68	186.0	12.79	190.8	12.91
	87.8	124.8	8.02	148.8	10.28	172.8	12.83	176.4	13.11	178.8	13.17	183.6	13.28	187.8	13.42
	91.4	124.8	8.53	148.8	10.96	171.6	13.53	174.0	13.60	176.4	13.66	180.6	13.79	185.4	13.92
	95.0	124.8	9.08	148.8	11.68	169.2	14.02	171.0	14.09	173.4	14.17	177.6	14.30	182.4	14.43
	98.6	124.8	9.66	148.8	12.43	166.2	14.53	168.6	14.58	170.4	14.66	175.2	14.81	179.4	14.94
	102.2	124.8	10.26	148.8	13.25	163.2	15.02	165.6	15.09	168.0	15.17	172.2	15.32	177.0	15.47
105.8	117.9	11.44	141.4	14.72	160.8	17.66	162.5	16.35	164.9	16.44	169.1	16.59	173.8	16.74	
111.2	109.8	12.43	133.9	16.00	153.1	19.63	155.6	18.46	158.3	17.71	162.7	17.45	167.8	17.61	
116.6	103.6	16.54	129.5	21.29	148.1	20.61	150.1	18.75	152.6	18.85	157.2	18.74	162.3	18.91	
122.0	94.8	16.25	116.1	20.91	132.1	21.73	133.9	20.30	136.1	20.12	140.3	20.02	145.9	19.77	
125.6	71.9	13.70	86.3	17.64	99.0	18.50	100.9	18.46	104.0	18.14	111.9	17.88	118.6	17.32	

Combination	Outdoor air temp (°FDB)	Indoor air temp													
		57.2°FWB		60.8°FWB		64.4°FWB		66.2°FWB		68°FWB		71.6°FWB		75.2°FWB	
		68°FDB		73.4°FDB		78.8°FDB		80.6°FDB		82.4°FDB		86°FDB		89.6°FDB	
		TC	PI	TC	PI	TC	PI	TC	PI	TC	PI	TC	PI	TC	PI
	kBtu/h	kW	kBtu/h	kW	kBtu/h	kW	kBtu/h	kW	kBtu/h	kW	kBtu/h	kW	kBtu/h	kW	
100%	23.0	113.4	4.26	135.0	5.46	157.2	6.80	168.0	7.52	178.8	7.56	201.0	7.62	212.3	7.69
	32.0	113.4	4.27	135.0	5.47	157.2	6.82	168.0	7.53	178.8	7.57	201.0	7.64	212.3	7.71
	39.2	113.4	4.29	135.0	5.49	157.2	6.84	168.0	7.56	178.8	7.60	201.0	7.67	212.3	7.74
	44.6	113.4	4.36	135.0	5.59	157.2	6.97	168.0	7.70	178.8	7.74	201.0	7.81	212.3	7.88
	50.0	113.4	4.83	135.0	5.87	157.2	6.94	168.0	7.49	178.8	8.09	200.9	9.16	212.4	9.52
	53.6	113.4	4.89	135.0	5.95	157.2	7.03	168.0	7.59	178.8	8.25	200.9	9.32	209.4	9.44
	57.2	113.4	4.98	135.0	6.05	157.2	7.15	168.0	7.73	178.8	8.40	200.9	9.48	207.0	9.37
	60.8	113.4	5.09	135.0	6.18	157.2	7.31	168.0	7.91	178.8	8.59	200.3	9.69	204.0	9.58
	64.4	113.4	5.21	135.0	6.32	157.2	7.46	168.0	8.06	178.8	8.76	197.4	9.88	201.6	10.03
	68.0	113.4	5.28	135.0	6.42	157.2	7.70	168.0	8.48	178.8	9.31	194.4	10.40	198.6	10.56
	69.8	113.4	5.34	135.0	6.48	157.2	7.97	168.0	8.77	178.8	9.63	193.2	10.75	197.4	10.85
	73.4	113.4	5.47	135.0	6.93	157.2	8.57	168.0	9.43	178.8	10.36	190.8	11.38	194.4	11.48
	77.0	113.4	5.82	135.0	7.37	157.2	9.11	168.0	10.04	178.8	11.08	187.8	11.79	192.0	11.90
	80.6	113.4	6.22	135.0	7.87	157.2	9.78	168.0	10.77	178.8	11.89	184.8	12.21	189.0	12.32
	84.2	113.4	6.59	135.0	8.41	157.2	10.46	168.0	11.52	178.2	12.59	182.3	12.80	186.5	12.91
	87.8	113.4	7.01	135.0	8.96	157.2	11.15	168.0	12.41	176.0	13.10	178.1	13.32	183.6	13.44
	91.4	113.4	7.46	135.0	9.54	157.2	11.88	168.0	13.13	172.8	13.58	177.2	13.70	181.1	13.82
	95.0	113.4	7.94	135.0	10.16	157.2	12.67	168.0	14.00	169.8	14.07	173.9	14.20	178.1	14.32
	98.6	113.4	8.45	135.0	10.82	157.2	13.49	165.0	14.50	167.7	14.58	171.4	14.68	175.6	14.81
	102.2	113.4	9.00	135.0	11.53	157.2	14.37	162.8	14.98	163.6	15.06	169.2	15.16	171.4	15.30
105.8	107.2	10.00	128.2	12.80	149.4	15.96	159.7	16.24	161.5	16.32	165.5	16.47	169.7	16.62	
111.2	99.8	10.87	121.5	13.92	142.3	17.74	152.9	18.34	155.0	17.59	159.3	17.32	163.8	17.48	
116.6	94.1	14.47	117.4	18.52	137.5	18.62	147.5	18.62	149.4	18.71	153.9	18.60	158.5	18.76	
122.0	86.2	14.21	105.3	18.19	122.8	19.64	131.5	20.16	133.3	19.98	137.4	19.88	142.5	19.62	
125.6	65.3	11.98	78.3	15.34	92.0	16.72	99.1	18.34	101.9	18.01	109.5	17.75	115.8	17.19	
90%	23.0	102.1	3.72	121.5	4.71	141.5	5.81	151.2	6.42	160.8	7.06	180.6	7.56	200.4	7.62
	32.0	102.1	3.73	121.5	4.72	141.5	5.82	151.2	6.43	160.8	7.08	180.6	7.57	200.4	7.64
	39.2	102.1	3.74	121.5	4.73	141.5	5.84	151.2	6.46	160.8	7.10	180.6	7.60	200.4	7.67
	44.6	102.1	3.81	121.5	4.82	141.5	5.95	151.2	6.58	160.8	7.23	180.6	7.74	200.4	7.81
	50.0	102.1	4.21	121.5	5.06	141.5	5.93	151.2	6.68	160.9	7.11	180.8	8.15	200.3	9.23
	53.6	102.1	4.27	121.5	5.13	141.5	6.01	151.2	6.77	160.9	7.25	180.8	8.29	200.3	9.35
	57.2	102.1	4.34	121.5	5.22	141.5	6.11	151.2	6.87	160.9	7.37	180.8	8.43	200.3	9.50
	60.8	102.1	4.44	121.5	5.33	141.5	6.25	151.2	7.02	160.9	7.54	180.8	8.62	199.7	9.69
	64.4	102.1	4.54	121.5	5.45	141.5	6.37	151.2	7.16	160.9	7.68	180.8	8.82	197.9	10.04
	68.0	102.1	4.61	121.5	5.54	141.5	6.58	151.2	7.31	160.9	8.00	180.8	9.48	194.4	10.46
	69.8	102.1	4.66	121.5	5.59	141.5	6.80	151.2	7.55	160.9	8.28	180.8	9.80	193.2	10.69
	73.4	102.1	4.78	121.5	5.98	141.5	7.31	151.2	8.12	160.9	8.86	180.8	10.53	190.2	11.24
	77.0	102.1	5.08	121.5	6.36	141.5	7.78	151.2	8.66	160.9	9.48	180.8	11.26	187.8	11.70
	80.6	102.1	5.43	121.5	6.79	141.5	8.35	151.2	9.25	160.9	10.15	180.8	12.01	184.8	12.21
	84.2	102.1	5.75	121.5	7.26	141.5	8.93	151.2	9.88	160.9	10.83	178.8	12.59	182.4	12.71
	87.8	102.1	6.12	121.5	7.73	141.5	9.52	151.2	10.54	160.9	11.56	175.8	13.05	179.4	13.22
	91.4	102.1	6.51	121.5	8.23	141.5	10.15	151.2	11.21	160.9	12.30	173.4	13.58	177.0	13.70
	95.0	102.1	6.92	121.5	8.76	141.5	10.82	151.2	11.96	160.9	13.15	170.4	14.07	174.0	14.20
	98.6	102.1	7.37	121.5	9.33	141.5	11.52	148.5	12.39	160.9	14.07	167.4	14.58	171.6	14.54
	102.2	102.1	7.85	121.5	9.94	141.5	12.27	146.5	12.80	160.9	14.92	165.0	15.12	168.6	15.08
105.8	96.4	8.72	115.4	11.04	134.4	13.63	143.7	13.87	153.0	15.26	162.2	16.32	165.8	16.47	
111.2	89.8	9.49	109.3	12.01	128.0	15.15	137.6	15.66	146.9	16.44	156.1	17.17	160.1	17.32	
116.6	84.7	12.62	105.7	15.98	123.8	15.91	132.8	15.90	141.6	17.49	150.8	18.43	154.9	18.60	
122.0	77.6	12.39	94.8	15.69	110.5	16.77	118.4	17.22	126.3	18.68	134.6	19.70	139.2	19.45	
125.6	58.8	10.45	70.5	13.23	82.8	14.28	89.2	15.66	96.5	16.83	107.4	17.59	113.1	17.04	

GMV5 DC Inverter VRF Units Technical Sales Guide

Combination	Outdoor air temp (°FDB)	Indoor air temp													
		57.2°FWB		60.8°FWB		64.4°FWB		66.2°FWB		68°FWB		71.6°FWB		75.2°FWB	
		68°FDB		73.4°FDB		78.8°FDB		80.6°FDB		82.4°FDB		86°FDB		89.6°FDB	
		TC	PI	TC	PI	TC	PI	TC	PI	TC	PI	TC	PI	TC	PI
		kBtu/h	kW	kBtu/h	kW	kBtu/h	kW	kBtu/h	kW	kBtu/h	kW	kBtu/h	kW	kBtu/h	kW
80%	23.0	90.7	3.21	108.0	3.96	125.8	4.92	134.4	5.42	142.8	5.92	160.8	7.03	178.2	7.53
	32.0	90.7	3.22	108.0	3.97	125.8	4.93	134.4	5.43	142.8	5.94	160.8	7.05	178.2	7.55
	39.2	90.7	3.23	108.0	3.98	125.8	4.95	134.4	5.45	142.8	5.96	160.8	7.07	178.2	7.58
	44.6	90.7	3.29	108.0	4.06	125.8	5.04	134.4	5.55	142.8	6.07	160.8	7.20	178.2	7.72
	50.0	90.7	3.83	108.0	4.58	125.8	5.40	134.4	5.81	143.0	6.22	160.7	7.11	178.2	8.26
	53.6	90.7	3.89	108.0	4.66	125.8	5.49	134.4	5.92	143.0	6.34	160.7	7.23	178.2	8.19
	57.2	90.7	3.96	108.0	4.75	125.8	5.58	134.4	6.02	143.0	6.46	160.7	7.36	178.2	8.37
	60.8	90.7	4.02	108.0	4.83	125.8	5.70	134.4	6.13	143.0	6.56	160.7	7.52	178.2	8.68
	64.4	90.7	4.09	108.0	4.92	125.8	5.83	134.4	6.26	143.0	6.68	160.7	7.69	178.2	9.28
	68.0	90.7	4.17	108.0	5.02	125.8	5.92	134.4	6.38	143.0	6.83	160.7	7.97	178.2	9.62
	69.8	90.7	4.21	108.0	5.06	125.8	5.98	134.4	6.45	143.0	6.99	160.7	8.26	178.2	10.30
	73.4	90.7	4.28	108.0	5.17	125.8	6.26	134.4	6.87	143.0	7.47	160.7	8.83	178.2	11.01
	77.0	90.7	4.42	108.0	5.49	125.8	6.70	134.4	7.34	143.0	7.98	160.7	9.46	178.2	11.75
	80.6	90.7	4.70	108.0	5.85	125.8	7.13	134.4	7.83	143.0	8.56	160.7	10.09	178.2	12.17
	84.2	90.7	5.00	108.0	6.23	125.8	7.60	134.4	8.34	142.6	9.12	160.7	10.77	178.2	12.61
	87.8	90.7	5.30	108.0	6.62	125.8	8.09	134.4	8.89	142.6	9.73	160.7	11.50	175.2	13.07
	91.4	90.7	5.64	108.0	7.38	125.8	8.62	134.4	9.47	142.6	10.36	160.7	12.27	172.8	13.54
	95.0	90.7	5.98	108.0	7.38	125.8	9.17	134.4	10.09	142.6	11.03	160.7	13.10	169.8	14.03
	98.6	90.7	6.34	108.0	7.94	125.8	9.75	132.0	10.75	142.6	11.75	160.7	13.95	167.4	14.55
	102.2	90.7	6.72	108.0	8.43	125.8	10.38	130.2	11.45	142.6	12.51	160.7	14.85	164.4	15.09
105.8	85.7	7.54	102.6	9.30	119.5	11.55	127.7	11.71	135.6	12.80	153.0	15.19	161.8	16.28	
111.2	79.8	8.19	97.2	10.11	113.8	12.84	122.3	13.22	130.2	13.79	147.2	15.98	156.2	17.12	
116.6	75.3	10.90	94.0	13.45	110.0	13.48	118.0	13.43	125.5	14.67	142.3	17.16	151.1	18.38	
122.0	68.9	10.71	84.2	13.21	98.2	14.21	105.2	14.54	111.9	15.67	127.0	18.33	135.8	19.22	
125.6	52.3	9.03	62.6	11.14	73.6	12.10	79.3	13.22	85.5	14.12	101.3	16.37	110.4	16.84	
70%	23.0	79.4	2.74	94.5	3.38	110.0	4.10	117.6	4.50	125.4	4.90	140.4	5.78	156.0	6.72
	32.0	79.4	2.74	94.5	3.39	110.0	4.11	117.6	4.51	125.4	4.91	140.4	5.79	156.0	6.73
	39.2	79.4	2.75	94.5	3.40	110.0	4.13	117.6	4.52	125.4	4.93	140.4	5.81	156.0	6.76
	44.6	79.4	2.80	94.5	3.47	110.0	4.20	117.6	4.61	125.4	5.02	140.4	5.92	156.0	6.88
	50.0	79.4	3.38	94.5	4.00	110.0	4.66	117.6	5.02	125.1	5.38	140.6	6.11	156.0	6.87
	53.6	79.4	3.42	94.5	4.06	110.0	4.75	117.6	5.11	125.1	5.47	140.6	6.23	156.0	7.00
	57.2	79.4	3.47	94.5	4.13	110.0	4.83	117.6	5.19	125.1	5.57	140.6	6.34	156.0	7.13
	60.8	79.4	3.53	94.5	4.21	110.0	4.92	117.6	5.30	125.1	5.68	140.6	6.45	156.0	7.26
	64.4	79.4	3.58	94.5	4.28	110.0	5.02	117.6	5.40	125.1	5.77	140.6	6.58	156.0	7.42
	68.0	79.4	3.64	94.5	4.36	110.0	5.11	117.6	5.49	125.1	5.89	140.6	6.72	156.0	7.62
	69.8	79.4	3.68	94.5	4.40	110.0	5.15	117.6	5.55	125.1	5.94	140.6	6.79	156.0	7.89
	73.4	79.4	3.74	94.5	4.47	110.0	5.26	117.6	5.74	125.1	6.25	140.6	7.30	156.0	8.45
	77.0	79.4	3.81	94.5	4.66	110.0	5.60	117.6	6.13	125.1	6.66	140.6	7.81	156.0	9.04
	80.6	79.4	4.04	94.5	4.96	110.0	5.98	117.6	6.53	125.1	7.11	140.6	8.34	156.0	9.66
	84.2	79.4	4.28	94.5	5.26	110.0	6.36	117.6	6.96	125.1	7.57	140.6	8.89	156.0	10.32
	87.8	79.4	4.53	94.5	5.58	110.0	6.77	117.6	7.40	125.1	8.06	140.6	9.47	156.0	11.00
	91.4	79.4	4.81	94.5	5.94	110.0	7.21	117.6	7.87	125.1	8.58	140.6	10.09	156.0	11.74
	95.0	79.4	5.09	94.5	6.30	110.0	7.64	117.6	8.38	125.1	9.13	140.6	10.75	156.0	12.51
	98.6	79.4	5.38	94.5	6.68	110.0	8.13	115.5	8.91	125.1	9.72	140.6	11.45	156.0	13.32
	102.2	79.4	5.70	94.5	7.08	110.0	8.62	113.9	9.45	125.1	10.32	140.6	12.17	156.0	14.19
105.8	75.0	6.42	89.8	7.94	104.6	9.63	111.8	9.72	119.0	10.59	133.9	12.48	148.7	14.51	
111.2	69.9	6.98	85.0	8.63	99.6	10.70	107.0	10.97	114.3	11.42	128.8	13.12	143.5	15.26	
116.6	65.9	9.29	82.2	11.49	96.3	11.23	103.3	11.14	110.1	12.15	124.5	14.09	138.8	16.39	
122.0	60.3	9.12	73.7	11.28	85.9	11.84	92.1	12.06	98.2	12.97	111.1	15.06	124.8	17.14	
125.6	45.7	7.69	54.8	9.52	64.4	10.09	69.4	10.97	75.1	11.69	88.6	13.44	101.4	15.01	

Combination	Outdoor air temp (°FDB)	Indoor air temp													
		57.2°FWB		60.8°FWB		64.4°FWB		66.2°FWB		68°FWB		71.6°FWB		75.2°FWB	
		68°FDB		73.4°FDB		78.8°FDB		80.6°FDB		82.4°FDB		86°FDB		89.6°FDB	
		TC	PI	TC	PI	TC	PI	TC	PI	TC	PI	TC	PI	TC	PI
	kBtu/h	kW	kBtu/h	kW	kBtu/h	kW	kBtu/h	kW	kBtu/h	kW	kBtu/h	kW	kBtu/h	kW	
60%	23.0	68.0	2.30	81.0	2.81	94.3	3.36	100.8	3.67	107.4	3.98	120.6	4.65	133.8	5.37
	32.0	68.0	2.30	81.0	2.81	94.3	3.37	100.8	3.67	107.4	3.99	120.6	4.66	133.8	5.38
	39.2	68.0	2.31	81.0	2.82	94.3	3.38	100.8	3.69	107.4	4.00	120.6	4.68	133.8	5.40
	44.6	68.0	2.36	81.0	2.87	94.3	3.45	100.8	3.76	107.4	4.08	120.6	4.76	133.8	5.50
	50.0	68.0	2.92	81.0	3.43	94.3	3.98	100.8	4.26	107.3	4.55	120.6	5.15	133.8	5.77
	53.6	68.0	2.98	81.0	3.49	94.3	4.06	100.8	4.34	107.3	4.62	120.6	5.25	133.8	5.87
	57.2	68.0	3.02	81.0	3.55	94.3	4.11	100.8	4.42	107.3	4.72	120.6	5.34	133.8	5.98
	60.8	68.0	3.06	81.0	3.60	94.3	4.19	100.8	4.49	107.3	4.79	120.6	5.43	133.8	6.09
	64.4	68.0	3.11	81.0	3.66	94.3	4.26	100.8	4.57	107.3	4.89	120.6	5.53	133.8	6.21
	68.0	68.0	3.15	81.0	3.74	94.3	4.34	100.8	4.66	107.3	4.98	120.6	5.64	133.8	6.34
	69.8	68.0	3.19	81.0	3.75	94.3	4.38	100.8	4.70	107.3	5.02	120.6	5.70	133.8	6.40
	73.4	68.0	3.23	81.0	3.83	94.3	4.45	100.8	4.79	107.3	5.11	120.6	5.92	133.8	6.81
	77.0	68.0	3.28	81.0	3.91	94.3	4.62	100.8	5.02	107.3	5.43	120.6	6.32	133.8	7.26
	80.6	68.0	3.42	81.0	4.13	94.3	4.92	100.8	5.36	107.3	5.79	120.6	6.74	133.8	7.75
	84.2	68.0	3.60	81.0	4.38	94.3	5.25	100.8	5.70	107.3	6.17	120.6	7.19	133.8	8.28
	87.8	68.0	3.83	81.0	4.66	94.3	5.57	100.8	6.06	107.3	6.57	120.6	7.64	133.8	8.81
	91.4	68.0	4.04	81.0	4.92	94.3	5.91	100.8	6.43	107.3	6.98	120.6	8.13	133.8	9.40
	95.0	68.0	4.28	81.0	5.23	94.3	6.26	100.8	6.83	107.3	7.42	120.6	8.66	133.8	10.00
	98.6	68.0	4.53	81.0	5.53	94.3	6.64	99.0	7.25	107.3	7.87	120.6	9.21	133.8	10.64
	102.2	68.0	4.77	81.0	5.85	94.3	7.04	97.7	7.68	107.3	8.36	120.6	9.77	133.8	11.32
105.8	64.3	5.40	76.9	6.59	89.6	7.89	95.8	7.92	102.0	8.60	114.8	10.05	127.5	11.60	
111.2	59.9	5.87	72.9	7.16	85.4	8.77	91.7	8.95	97.9	9.27	110.4	10.57	123.1	12.20	
116.6	56.5	7.81	70.5	9.53	82.5	9.21	88.5	9.08	94.4	9.86	106.7	11.35	119.1	13.10	
122.0	51.7	7.67	63.2	9.36	73.7	9.71	78.9	9.84	84.2	10.53	95.2	12.12	107.0	13.70	
125.6	39.2	6.47	47.0	7.89	55.2	8.27	59.5	8.95	64.4	9.49	76.0	10.83	87.0	12.00	
50%	23.0	56.7	1.90	67.5	2.28	78.6	2.70	84.0	2.92	89.4	3.15	100.5	3.65	111.6	4.17
	32.0	56.7	1.91	67.5	2.28	78.6	2.70	84.0	2.92	89.4	3.16	100.5	3.65	111.6	4.18
	39.2	56.7	1.92	67.5	2.29	78.6	2.71	84.0	2.93	89.4	3.17	100.5	3.67	111.6	4.20
	44.6	56.7	1.95	67.5	2.33	78.6	2.76	84.0	2.99	89.4	3.23	100.5	3.74	111.6	4.28
	50.0	56.7	2.53	67.5	2.92	78.6	3.34	84.0	3.57	89.4	3.77	100.5	4.25	111.6	4.74
	53.6	56.7	2.55	67.5	2.96	78.6	3.40	84.0	3.60	89.4	3.85	100.5	4.32	111.6	4.81
	57.2	56.7	2.58	67.5	3.00	78.6	3.43	84.0	3.68	89.4	3.91	100.5	4.40	111.6	4.91
	60.8	56.7	2.62	67.5	3.04	78.6	3.49	84.0	3.74	89.4	3.96	100.5	4.47	111.6	4.98
	64.4	56.7	2.66	67.5	3.09	78.6	3.55	84.0	3.79	89.4	4.04	100.5	4.55	111.6	5.08
	68.0	56.7	2.70	67.5	3.13	78.6	3.60	84.0	3.87	89.4	4.11	100.5	4.64	111.6	5.17
	69.8	56.7	2.72	67.5	3.17	78.6	3.64	84.0	3.89	89.4	4.15	100.5	4.68	111.6	5.23
	73.4	56.7	2.75	67.5	3.21	78.6	3.70	84.0	3.96	89.4	4.23	100.5	4.75	111.6	5.34
	77.0	56.7	2.79	67.5	3.26	78.6	3.77	84.0	4.04	89.4	4.36	100.5	5.00	111.6	5.70
	80.6	56.7	2.85	67.5	3.40	78.6	3.98	84.0	4.30	89.4	4.62	100.5	5.32	111.6	6.08
	84.2	56.7	3.00	67.5	3.58	78.6	4.23	84.0	4.57	89.1	4.92	100.5	5.66	111.6	6.47
	87.8	56.7	3.17	67.5	3.79	78.6	4.51	84.0	4.85	89.1	5.23	100.5	6.02	111.6	6.89
	91.4	56.7	3.36	67.5	4.02	78.6	4.75	84.0	5.13	89.1	5.55	100.5	6.40	111.6	7.32
	95.0	56.7	3.55	67.5	4.25	78.6	5.02	84.0	5.43	89.1	5.87	100.5	6.79	111.6	7.77
	98.6	56.7	3.74	67.5	4.49	78.6	5.32	82.5	5.75	89.1	6.23	100.5	7.21	111.6	8.26
	102.2	56.7	3.94	67.5	4.74	78.6	5.62	81.4	6.09	89.1	6.60	100.5	7.64	111.6	8.77
105.8	53.6	4.47	64.1	5.35	74.7	6.32	79.8	6.30	84.7	6.81	95.6	7.88	106.4	9.02	
111.2	49.9	4.86	60.7	5.82	71.1	7.03	76.4	7.12	81.3	7.33	92.0	8.29	102.7	9.48	
116.6	47.1	6.47	58.7	7.74	68.8	7.38	73.8	7.23	78.4	7.80	88.9	8.90	99.3	10.18	
122.0	43.1	6.35	52.6	7.60	61.4	7.78	65.8	7.82	69.9	8.33	79.4	9.51	89.3	10.65	
125.6	32.7	5.36	39.1	6.41	46.0	6.62	49.6	7.12	53.5	7.51	63.3	8.49	72.5	9.33	

GMV5 DC Inverter VRF Units Technical Sales Guide

► Heating Capacity Calculation Method GMV-72WM/B-F(U), GMV-72WM/B-U(U)

TC—Total capacity of outdoor unit; PI—Power input of outdoor unit

Combination	Outdoor air temp.		Indoor air temperature											
			61		64		68		70		72		75	
	°FDB	°FWB	TC	PI	TC	PI	TC	PI	TC	PI	TC	PI	TC	PI
135%	-3.6	-4.0	52.5	4.10	52.2	4.38	51.9	4.68	51.9	4.82	51.7	4.96	51.7	5.26
	-1.8	-2.2	53.2	4.19	53.0	4.47	53.0	4.76	52.7	4.90	52.7	5.04	52.5	5.33
	1.9	1.4	55.3	4.38	55.0	4.66	54.8	4.93	54.8	5.05	54.8	5.21	54.5	5.48
	7.3	5.0	57.6	4.59	57.3	4.85	57.1	5.11	57.1	5.24	56.8	5.38	56.8	5.64
	10.8	8.6	59.9	4.79	59.9	5.05	59.7	5.30	59.4	5.42	59.4	5.55	59.1	5.80
	14.4	12.2	62.7	5.00	62.5	5.24	62.2	5.48	62.2	5.60	62.2	5.73	62.0	5.97
	14.9	14.0	64.3	5.11	64.0	5.34	63.8	5.57	63.8	5.69	63.5	5.81	63.5	6.04
	16.7	15.6	65.6	5.20	65.3	5.42	65.3	5.66	65.1	5.77	65.1	5.88	64.8	6.12
	19.4	18.3	67.9	5.35	67.9	5.57	67.6	5.79	67.6	5.91	67.4	6.01	67.1	6.24
	23.0	21.9	71.5	5.55	71.2	5.65	71.0	5.97	71.0	6.08	70.7	6.18	70.7	6.39
	26.6	25.3	74.8	5.73	74.6	5.94	74.6	6.13	74.3	6.24	74.3	6.34	74.1	6.53
	32.0	30.7	80.7	6.01	80.7	6.20	80.5	6.38	80.5	6.47	80.2	6.57	80.2	6.75
	37.4	36.0	87.2	6.26	86.9	6.43	86.7	6.61	86.7	6.69	86.7	6.78	86.4	6.95
	41.0	39.4	91.5	6.42	91.3	6.58	91.3	6.74	91.0	6.82	91.0	6.91	90.8	7.07
	44.6	42.8	96.2	6.57	95.9	6.72	95.9	6.88	95.7	6.20	95.7	7.03	91.8	6.75
	48.2	46.2	101.1	6.70	100.8	6.86	100.8	7.00	100.5	7.07	98.5	6.93	91.8	6.34
	51.8	49.6	106.2	6.84	105.9	6.98	105.4	7.07	101.8	6.79	98.5	6.51	91.8	5.97
	55.4	53.2	111.9	6.97	111.6	7.10	105.4	6.62	101.8	6.36	98.5	6.11	91.8	5.60
59.0	56.7	117.3	7.09	112.1	6.73	105.4	6.24	101.8	6.00	98.5	5.76	91.8	5.29	
64.4	62.2	117.3	6.71	112.1	6.40	105.4	5.91	101.8	5.69	98.5	5.44	91.8	5.02	
68.0	65.3	117.3	6.39	112.1	6.12	105.4	5.64	101.8	5.44	98.5	5.17	91.8	4.80	
75.2	68.9	117.3	6.11	112.1	5.88	105.4	5.42	101.8	5.23	98.5	4.93	91.8	4.63	
120%	-3.6	-4.0	52.2	4.49	51.9	4.75	51.7	5.02	51.7	5.15	51.7	5.29	51.4	5.56
	-1.8	-2.2	53.0	4.57	52.7	4.84	52.7	5.05	52.5	5.23	52.5	5.36	52.2	5.63
	1.9	1.4	55.0	4.75	54.8	5.01	54.8	5.26	54.5	5.39	54.5	5.51	54.3	5.76
	7.3	5.0	57.3	4.94	57.1	5.18	56.8	5.42	56.8	5.55	56.8	5.67	56.6	5.91
	10.8	8.6	59.7	5.13	59.7	5.36	59.4	5.60	59.4	5.72	59.1	5.83	59.1	6.06
	14.4	12.2	62.5	5.33	62.2	5.54	62.2	5.77	62.0	5.88	62.0	5.99	61.7	6.22
	14.9	14.0	64.0	5.42	63.8	5.64	63.5	5.85	63.5	5.97	63.5	6.03	63.3	6.29
	16.7	15.6	65.3	5.51	65.1	5.72	65.1	5.93	64.8	6.03	64.8	6.15	64.5	6.36
	19.4	18.3	67.6	5.65	67.6	5.85	67.4	6.06	67.4	6.16	67.1	6.26	67.1	6.46
	23.0	21.9	71.2	5.83	71.0	6.03	70.7	6.22	70.7	6.32	70.7	6.42	70.5	6.61
	26.6	25.3	74.6	6.00	74.6	6.19	74.3	6.37	74.3	6.46	74.1	6.56	74.1	6.74
	32.0	30.7	80.5	6.26	80.5	6.43	80.2	6.68	80.2	6.69	80.0	6.77	80.0	6.95
	37.4	36.0	86.9	6.49	86.7	6.65	86.7	6.81	86.4	6.89	86.4	6.97	84.6	6.93
	41.0	39.4	91.3	6.64	91.0	6.79	91.0	6.94	90.8	7.01	90.8	7.09	84.6	6.51
	44.6	42.8	95.9	6.77	95.9	6.92	95.7	7.06	94.1	6.96	91.0	6.67	84.6	6.12
	48.2	46.2	100.8	6.91	100.5	7.04	97.2	6.81	94.1	6.54	91.0	6.27	84.6	5.76
	51.8	49.6	105.9	7.03	103.4	6.91	97.2	6.40	94.1	6.15	91.0	5.91	84.6	5.43
	55.4	53.2	109.8	6.96	103.4	6.48	97.2	6.00	94.1	5.78	91.0	5.55	84.6	5.11
59.0	56.7	109.8	6.55	103.4	6.10	97.2	5.66	94.1	5.45	91.0	5.24	84.6	4.82	
64.4	62.2	109.8	6.19	103.4	5.78	97.2	5.38	94.1	5.16	91.0	4.96	84.6	4.57	
68.0	65.3	109.8	5.87	103.4	5.51	97.2	5.15	94.1	4.92	91.0	4.72	84.6	4.35	
75.2	68.9	109.8	5.58	103.4	5.29	97.2	4.96	94.1	4.72	91.0	4.53	84.6	4.17	

Combination	Outdoor air temp.		Indoor air temperature											
			61		64		68		70		72		75	
	°FDB	°FWB	TC KBtu/h	PI kW	TC KBtu/h	PI kW	TC KBtu/h	PI kW	TC KBtu/h	PI kW	TC KBtu/h	PI kW	TC KBtu/h	PI kW
110%	-3.6	-4.0	51.9	4.88	51.7	5.12	51.4	5.37	51.4	5.49	51.4	5.61	51.2	5.86
	-1.8	-2.2	52.7	4.96	52.7	5.20	52.5	5.44	52.5	5.56	52.2	5.68	52.2	5.92
	1.9	1.4	54.8	5.12	54.5	5.36	54.5	5.59	54.3	5.70	54.3	5.82	54.0	6.05
	7.3	5.0	57.1	5.30	56.8	5.52	56.6	5.74	56.6	5.85	56.6	5.97	56.3	6.18
	10.8	8.6	59.4	5.48	59.4	5.69	59.1	5.90	59.1	6.00	58.9	6.11	58.9	6.33
	14.4	12.2	62.2	5.65	62.0	5.85	62.0	6.06	61.7	6.16	61.7	6.26	61.7	6.46
	14.9	14.0	63.8	5.74	63.5	5.94	63.3	6.14	63.3	6.24	63.3	6.34	63.0	6.53
	16.7	15.6	65.1	5.82	64.8	6.01	64.8	6.21	64.8	6.31	64.5	6.40	64.5	6.59
	19.4	18.3	67.4	5.95	67.4	6.13	67.1	6.32	67.1	6.42	67.9	6.51	66.9	6.70
	23.0	21.9	71.0	6.12	70.7	6.30	70.5	6.47	70.5	6.56	73.8	6.65	70.2	6.83
	26.6	25.3	74.3	6.27	74.3	6.44	74.1	6.61	74.1	6.70	80.0	6.78	73.8	6.95
	32.0	30.7	80.2	6.51	80.2	6.67	80.0	6.82	80.0	6.90	83.3	6.98	77.7	6.85
	37.4	36.0	86.7	6.73	86.4	6.87	86.4	7.01	86.1	7.08	83.3	6.79	77.7	6.23
	41.0	39.4	91.0	6.86	91.0	7.00	89.2	6.93	86.1	6.65	83.3	6.39	77.7	5.86
	44.6	42.8	95.7	6.98	94.9	7.03	89.2	6.51	86.1	6.25	83.3	6.00	77.7	5.51
	48.2	46.2	100.5	7.10	94.9	6.61	89.2	6.12	86.1	5.88	83.3	5.65	77.7	5.20
	51.8	49.6	100.5	6.67	94.9	6.21	89.2	5.76	86.1	5.54	83.3	5.33	77.7	4.90
	55.4	53.2	100.5	6.26	94.9	5.83	89.2	5.42	86.1	5.21	83.3	5.01	77.7	4.62
	59.0	56.7	100.5	5.90	94.9	5.50	89.2	5.11	86.1	4.92	83.3	4.74	77.7	4.37
	64.4	62.2	100.5	5.58	94.9	5.21	89.2	4.66	86.1	4.66	83.3	4.51	77.7	4.16
68.0	65.3	100.5	5.30	94.9	4.96	89.2	4.42	86.1	4.44	83.3	4.32	77.7	3.98	
75.2	68.9	100.5	5.05	94.9	4.73	89.2	4.21	86.1	4.25	83.3	4.17	77.7	3.83	
100%	-3.6	-4.0	51.7	5.27	51.4	5.49	51.4	5.72	51.2	5.83	51.2	5.94	50.9	6.16
	-1.8	-2.2	52.5	5.34	52.5	5.56	52.2	5.78	52.2	5.89	51.9	6.00	51.9	6.22
	1.9	1.4	54.5	5.49	54.3	5.70	54.3	5.91	54.3	6.02	54.0	6.12	54.0	6.34
	7.3	5.0	56.8	5.65	56.6	5.85	56.6	6.06	56.3	6.16	56.3	6.26	56.1	6.46
	10.8	8.6	59.1	5.82	59.1	6.00	58.9	6.20	58.9	6.30	58.9	6.17	58.6	6.59
	14.4	12.2	62.0	5.97	61.7	6.16	61.7	6.34	61.7	6.44	61.5	6.53	61.5	6.71
	14.9	14.0	63.5	6.06	63.3	6.24	63.3	6.42	63.0	6.51	63.0	6.60	62.7	6.78
	16.7	15.6	64.8	6.12	64.8	6.31	64.5	6.48	64.5	6.57	64.3	6.66	64.3	6.83
	19.4	18.3	67.1	6.24	67.1	6.42	66.9	6.58	66.9	6.67	66.9	6.76	66.6	6.93
	23.0	21.9	70.7	6.40	70.5	6.56	70.5	6.73	70.2	6.81	70.2	6.89	70.2	7.05
	26.6	25.3	74.1	6.55	74.1	6.70	73.8	6.86	73.8	6.93	73.8	7.01	70.7	6.71
	32.0	30.7	80.0	6.76	80.0	6.90	79.7	7.04	78.4	6.93	75.9	6.64	70.7	6.10
	37.4	36.0	86.4	6.95	86.1	7.08	81.0	6.55	78.4	6.30	75.9	6.05	70.7	5.55
	41.0	39.4	90.8	7.08	86.1	6.65	81.0	6.16	78.4	5.93	75.9	5.69	70.7	5.24
	44.6	42.8	91.3	6.72	86.1	6.25	81.0	5.80	78.4	5.58	75.9	5.36	70.7	4.93
	48.2	46.2	91.3	6.31	86.1	5.88	81.0	5.46	78.4	5.26	75.9	5.05	70.7	4.66
	51.8	49.6	91.3	5.94	86.1	5.54	81.0	5.15	78.4	4.96	75.9	4.77	70.7	4.40
	55.4	53.2	91.3	5.58	86.1	5.21	81.0	4.85	78.4	4.67	75.9	4.50	70.7	4.15
	59.0	56.7	91.3	5.27	86.1	4.92	81.0	4.58	78.4	4.41	75.9	4.25	70.7	3.93
	64.4	62.2	91.3	4.96	86.1	4.69	81.0	4.43	78.4	4.19	75.9	4.02	70.7	3.74
68.0	65.3	91.3	4.69	86.1	4.50	81.0	4.25	78.4	4.00	75.9	3.83	70.7	3.59	
75.2	68.9	91.3	4.43	86.1	4.35	81.0	4.08	78.4	3.85	75.9	3.68	70.7	3.48	

GMV5 DC Inverter VRF Units Technical Sales Guide

Combination	Outdoor air temp.		Indoor air temperature											
			61		64		68		70		72		75	
	°FDB	°FWB	TC KBtu/h	PI kW	TC KBtu/h	PI kW	TC KBtu/h	PI kW	TC KBtu/h	PI kW	TC KBtu/h	PI kW	TC KBtu/h	PI kW
90%	-3.6	-4.0	51.4	5.66	51.2	5.86	51.2	6.06	50.9	6.16	50.9	6.27	50.9	6.46
	-1.8	-2.2	52.2	5.73	52.2	5.93	51.9	6.12	51.9	6.22	51.9	6.32	51.7	6.52
	1.9	1.4	54.3	5.87	54.0	6.06	54.0	6.24	54.0	6.34	53.7	6.43	53.7	6.62
	7.3	5.0	56.6	6.01	56.3	6.19	56.3	6.37	56.1	6.40	56.1	6.55	56.1	6.73
	10.8	8.6	58.9	6.15	58.9	6.33	58.6	6.50	58.6	6.59	58.6	6.67	58.4	6.85
	14.4	12.2	61.7	6.30	61.7	6.46	61.5	6.63	61.5	6.72	61.5	6.80	61.2	6.97
	14.9	14.0	63.3	6.37	63.0	6.54	63.0	6.70	62.7	6.78	62.7	6.86	62.7	7.02
	16.7	15.6	64.5	6.44	64.5	6.60	64.3	6.76	64.3	6.83	64.3	6.92	63.5	6.98
	19.4	18.3	66.9	6.55	66.9	6.70	66.6	6.86	66.6	6.93	66.6	7.01	63.5	6.67
	23.0	21.9	70.5	6.69	70.2	6.83	70.2	6.98	70.2	7.05	68.1	6.83	63.5	6.27
	26.6	25.3	73.8	6.82	73.8	6.20	73.0	6.98	70.5	6.70	68.1	6.43	63.5	5.91
	32.0	30.7	80.0	7.01	77.7	6.09	73.0	6.34	70.5	6.09	68.1	5.85	63.5	5.37
	37.4	36.0	82.3	6.68	77.7	6.22	73.0	5.77	70.5	5.55	68.1	5.33	63.5	4.91
	41.0	39.4	82.3	6.28	77.7	5.85	73.0	5.44	70.5	5.23	68.1	5.03	63.5	4.63
	44.6	42.8	82.3	5.91	77.7	5.51	73.0	5.12	70.5	4.93	68.1	4.75	63.5	4.38
	48.2	46.2	82.3	5.57	77.7	5.19	73.0	4.83	70.5	4.66	68.1	4.48	63.5	4.14
	51.8	49.6	82.3	5.24	77.7	4.90	73.0	4.56	70.5	4.40	68.1	4.23	63.5	3.92
	55.4	53.2	82.3	4.93	77.7	4.62	73.0	4.30	70.5	4.15	68.1	4.00	63.5	3.70
	59.0	56.7	82.3	4.66	77.7	4.36	73.0	4.08	70.5	3.92	68.1	3.79	63.5	3.51
	64.4	62.2	82.3	4.41	77.7	4.12	73.0	3.86	70.5	3.70	68.1	3.59	63.5	3.34
68.0	65.3	82.3	4.17	77.7	3.89	73.0	3.67	70.5	3.49	68.1	3.41	63.5	3.19	
75.2	68.9	82.3	3.93	77.7	3.68	73.0	3.48	70.5	3.29	68.1	3.24	63.5	3.04	
80%	-3.6	-4.0	51.2	6.06	50.9	6.23	50.9	6.41	50.9	6.50	50.7	6.59	50.7	6.76
	-1.8	-2.2	51.9	6.11	51.9	6.29	51.7	6.46	51.7	6.55	51.7	6.64	51.4	6.82
	1.9	1.4	54.0	6.24	53.7	6.40	53.7	6.58	53.7	6.66	53.7	6.74	53.5	6.91
	7.3	5.0	56.3	6.37	56.1	6.52	56.1	6.69	56.1	6.76	55.8	6.85	55.8	7.01
	10.8	8.6	58.6	6.49	58.6	6.65	58.4	6.80	58.4	6.88	58.4	6.96	56.6	6.77
	14.4	12.2	61.5	6.62	61.5	6.77	61.2	6.92	61.2	6.99	60.7	6.98	56.6	6.40
	14.9	14.0	63.0	6.69	62.7	6.83	62.7	6.98	62.7	7.05	60.7	6.77	56.6	6.21
	16.7	15.6	64.3	6.75	64.3	6.89	64.0	7.03	62.7	6.88	60.7	6.59	56.6	6.04
	19.4	18.3	66.6	6.85	66.6	6.98	64.8	6.83	62.7	6.56	60.7	6.30	56.6	5.80
	23.0	21.9	70.2	6.21	68.9	6.93	64.8	6.42	62.7	6.17	60.7	5.92	56.6	5.44
	26.6	25.3	73.0	6.25	68.9	6.52	64.8	6.04	62.7	5.84	60.7	5.58	56.6	5.14
	32.0	30.7	73.0	6.36	68.9	5.92	64.8	5.50	62.7	5.30	60.7	5.08	56.6	4.69
	37.4	36.0	73.0	5.79	68.9	5.40	64.8	5.02	62.7	4.84	60.7	4.66	56.6	4.29
	41.0	39.4	73.0	5.45	68.9	5.09	64.8	4.74	62.7	4.56	60.7	4.40	56.6	4.06
	44.6	42.8	73.0	5.14	68.9	4.81	64.8	4.47	62.7	4.32	60.7	4.16	56.6	3.84
	48.2	46.2	73.0	4.85	68.9	4.53	64.8	4.25	62.7	4.08	60.7	3.93	56.6	3.64
	51.8	49.6	73.0	4.58	68.9	4.29	64.8	4.00	62.7	3.86	60.7	3.72	56.6	3.45
	55.4	53.2	73.0	4.32	68.9	4.05	64.8	3.78	62.7	3.65	60.7	3.52	56.6	3.26
	59.0	56.7	73.0	4.08	68.9	3.83	64.8	3.59	62.7	3.46	60.7	3.34	56.6	3.10
	64.4	62.2	73.0	3.89	68.9	3.65	64.8	3.41	62.7	3.28	60.7	3.16	56.6	2.96
68.0	65.3	73.0	3.74	68.9	3.50	64.8	3.26	62.7	3.13	60.7	3.01	56.6	2.82	
75.2	68.9	73.0	3.63	68.9	3.38	64.8	3.13	62.7	3.00	60.7	2.88	56.6	2.70	

Combination	Outdoor air temp.		Indoor air temperature											
			61		64		68		70		72		75	
	°FDB	°FWB	TC KBtu/h	PI kW	TC KBtu/h	PI kW	TC KBtu/h	PI kW	TC KBtu/h	PI kW	TC KBtu/h	PI kW	TC KBtu/h	PI kW
70%	-3.6	-4.0	50.9	6.45	50.7	6.60	50.7	6.76	50.7	6.83	50.7	6.92	49.4	6.84
	-1.8	-2.2	51.7	6.50	51.7	6.65	51.4	6.80	51.4	6.88	51.4	6.96	49.4	6.70
	1.9	1.4	53.7	6.61	53.7	6.76	53.5	6.90	53.5	6.98	53.0	6.97	49.4	6.39
	7.3	5.0	56.1	6.72	55.8	6.86	55.8	7.01	54.8	67.16	53.0	6.62	49.4	6.07
	10.8	8.6	58.4	6.83	58.4	6.97	56.8	6.80	54.8	6.54	53.0	6.27	49.4	5.76
	14.4	12.2	61.2	6.95	60.4	6.94	56.8	6.43	54.8	6.18	53.0	5.93	49.4	5.45
	14.9	14.0	62.7	7.01	60.4	6.73	56.8	6.24	54.8	6.00	53.0	5.76	49.4	5.30
	16.7	15.6	64.0	7.04	60.4	6.55	56.8	6.07	54.8	5.84	53.0	5.61	49.4	5.16
	19.4	18.3	64.0	6.73	60.4	6.26	56.8	5.81	54.8	5.59	53.0	5.37	49.4	4.94
	23.0	21.9	64.0	6.32	60.4	5.89	56.8	5.47	54.8	5.26	53.0	5.05	49.4	4.66
	26.6	25.3	64.0	5.95	60.4	5.55	56.8	5.16	54.8	4.96	53.0	4.78	49.4	4.41
	32.0	30.7	64.0	5.42	60.4	5.08	56.8	4.71	54.8	4.53	53.0	4.37	49.4	4.04
	37.4	36.0	64.0	4.95	60.4	0.11	56.8	4.32	54.8	4.16	53.0	4.01	49.4	3.71
	41.0	39.4	64.0	4.67	60.4	4.37	56.8	4.08	54.8	3.93	53.0	3.80	49.4	3.51
	44.6	42.8	64.0	4.41	60.4	4.14	56.8	3.86	54.8	3.72	53.0	3.59	49.4	3.33
	48.2	46.2	64.0	4.17	60.4	3.91	56.8	3.65	54.8	3.53	53.0	3.40	49.4	3.16
	51.8	49.6	64.0	3.95	60.4	3.70	56.8	3.47	54.8	3.34	53.0	3.23	49.4	3.00
	55.4	53.2	64.0	3.73	60.4	3.50	56.8	3.28	54.8	3.17	53.0	3.06	49.4	2.85
	59.0	56.7	64.0	3.53	60.4	3.32	56.8	3.11	54.8	3.01	53.0	2.91	49.4	2.71
	64.4	62.2	64.0	3.35	60.4	3.16	56.8	2.96	54.8	2.87	53.0	2.77	49.4	2.59
68.0	65.3	64.0	3.19	60.4	3.01	56.8	2.82	54.8	2.74	53.0	2.65	49.4	2.49	
75.2	68.9	64.0	3.05	60.4	2.87	56.8	2.71	54.8	2.63	53.0	2.55	49.4	2.40	
60%	-3.6	-4.0	50.7	6.84	50.4	6.97	48.6	6.70	47.1	6.44	45.5	6.18	42.4	5.67
	-1.8	-2.2	51.4	6.89	51.4	7.01	48.6	6.56	47.1	6.31	45.5	6.05	42.4	5.55
	1.9	1.4	53.5	6.98	51.7	6.76	48.6	6.26	47.1	6.02	45.5	5.78	42.4	5.31
	7.3	5.0	54.8	6.90	51.7	6.42	48.6	5.95	47.1	5.73	45.5	5.50	42.4	5.05
	10.8	8.6	54.8	6.53	51.7	6.08	48.6	5.64	47.1	5.43	45.5	5.22	42.4	4.81
	14.4	12.2	54.8	6.17	51.7	5.75	48.6	5.34	47.1	5.14	45.5	4.94	42.4	4.56
	14.9	14.0	54.8	6.00	51.7	5.59	48.6	5.19	47.1	5.00	45.5	4.81	42.4	4.43
	16.7	15.6	54.8	5.84	51.7	5.45	48.6	5.06	47.1	4.87	45.5	4.69	42.4	4.32
	19.4	18.3	54.8	5.58	51.7	5.21	48.6	4.84	47.1	4.67	45.5	4.49	42.4	4.15
	23.0	21.9	54.8	5.26	51.7	4.91	48.6	4.57	47.1	4.41	45.5	4.24	42.4	3.92
	26.6	25.3	54.8	4.96	51.7	4.64	48.6	4.34	47.1	4.17	45.5	4.02	42.4	3.71
	32.0	30.7	54.8	4.53	51.7	4.25	48.6	3.96	47.1	3.83	45.5	3.68	42.4	3.41
	37.4	36.0	54.8	4.16	51.7	3.90	48.6	3.65	47.1	3.52	45.5	3.40	42.4	0.14
	41.0	39.4	54.8	3.93	51.7	3.69	48.6	3.45	47.1	3.34	45.5	3.22	42.4	2.99
	44.6	42.8	54.8	3.72	51.7	3.50	48.6	3.27	47.1	3.16	45.5	3.06	42.4	2.84
	48.2	46.2	54.8	3.53	51.7	3.31	48.6	3.10	47.1	3.01	45.5	2.90	42.4	2.70
	51.8	49.6	54.8	3.34	51.7	3.15	48.6	2.95	47.1	2.86	45.5	2.76	42.4	2.58
	55.4	53.2	54.8	3.16	51.7	2.98	48.6	2.80	47.1	2.71	45.5	2.62	42.4	2.45
	59.0	56.7	54.8	3.01	51.7	2.83	48.6	2.67	47.1	2.58	45.5	2.50	42.4	2.34
	64.4	62.2	54.8	2.88	51.7	2.70	48.6	2.55	47.1	2.47	45.5	2.40	42.4	2.24
68.0	65.3	54.8	2.76	51.7	2.58	48.6	2.44	47.1	2.37	45.5	2.31	42.4	2.15	
75.2	68.9	54.8	2.65	51.7	2.47	48.6	2.35	47.1	2.29	45.5	2.23	42.4	2.08	

GMV5 DC Inverter VRF Units Technical Sales Guide

Combination	Outdoor air temp.		Indoor air temperature											
			61		64		68		70		72		75	
	°FDB	°FWB	TC KBtu/h	PI kW	TC KBtu/h	PI kW	TC KBtu/h	PI kW	TC KBtu/h	PI kW	TC KBtu/h	PI kW	TC KBtu/h	PI kW
50%	-3.6	-4.0	45.8	6.22	43.2	5.79	40.6	5.38	39.1	5.18	37.8	4.98	35.2	4.59
	-1.8	-2.2	45.8	6.09	43.2	5.67	40.6	5.27	39.1	5.07	37.8	4.87	35.2	4.50
	1.9	1.4	45.8	5.81	43.2	5.42	40.6	5.04	39.1	4.85	37.8	4.67	35.2	4.31
	7.3	5.0	45.8	5.53	43.2	5.16	40.6	4.80	39.1	4.63	37.8	4.45	35.2	4.11
	10.8	8.6	45.8	5.25	43.2	4.91	40.6	4.56	39.1	4.40	37.8	4.23	35.2	3.92
	14.4	12.2	45.8	4.97	43.2	4.65	40.6	4.33	39.1	4.17	37.8	4.02	35.2	3.72
	14.9	14.0	45.8	4.84	43.2	4.52	40.6	4.22	39.1	4.07	37.8	3.92	35.2	3.62
	16.7	15.6	45.8	4.72	43.2	4.41	40.6	4.11	39.1	3.97	37.8	3.83	35.2	3.54
	19.4	18.3	45.8	4.52	43.2	4.25	40.6	3.95	39.1	3.81	37.8	3.68	35.2	3.40
	23.0	21.9	45.8	4.26	43.2	4.00	40.6	3.74	39.1	3.61	37.8	3.48	35.2	3.22
	26.6	25.3	45.8	4.04	43.2	3.79	40.6	3.54	39.1	3.42	37.8	3.30	35.2	3.07
	32.0	30.7	45.8	3.71	43.2	3.48	40.6	3.26	39.1	3.15	37.8	3.04	35.2	2.83
	37.4	36.0	45.8	3.41	43.2	3.21	40.6	3.01	39.1	2.91	37.8	2.82	35.2	2.62
	41.0	39.4	45.8	3.24	43.2	3.04	40.6	2.86	39.1	2.76	37.8	2.67	35.2	2.49
	44.6	42.8	45.8	3.07	43.2	2.89	40.6	2.72	39.1	2.63	37.8	2.55	35.2	2.38
	48.2	46.2	45.8	2.92	43.2	2.75	40.6	2.58	39.1	2.51	37.8	2.43	35.2	2.27
	51.8	49.6	45.8	2.77	43.2	2.61	40.6	2.46	39.1	2.39	37.8	2.31	35.2	2.16
	55.4	53.2	45.8	2.64	43.2	2.49	40.6	2.34	39.1	2.27	37.8	2.20	35.2	2.06
59.0	56.7	45.8	2.51	43.2	2.37	40.6	2.24	39.1	2.17	37.8	2.10	35.2	1.97	
64.4	62.2	45.8	2.39	43.2	2.27	40.6	2.15	39.1	2.08	37.8	2.01	35.2	1.88	
68.0	65.3	45.8	2.27	43.2	2.17	40.6	2.06	39.1	2.00	37.8	1.93	35.2	1.79	
75.2	68.9	45.8	2.17	43.2	2.08	40.6	1.92	39.1	1.94	37.8	1.85	35.2	1.72	

GMV-96WM/B-F(U), GMV-96WM/B-U(U)

TC—Total capacity of outdoor unit; PI—Power input of outdoor unit

Combination	Outdoor air temp.		Indoor air temperature											
			61		64		68		70		72		75	
	°FDB	°FWB	TC KBtu/h	PI kW	TC KBtu/h	PI kW	TC KBtu/h	PI kW	TC KBtu/h	PI kW	TC KBtu/h	PI kW	TC KBtu/h	PI kW
135%	-3.6	-4.0	69.9	5.55	69.6	5.93	69.3	6.33	69.3	6.52	68.9	6.72	68.9	7.12
	-1.8	-2.2	71.0	5.67	70.6	6.06	70.6	6.44	70.3	6.64	70.3	6.82	69.9	7.21
	1.9	1.4	73.7	5.93	73.4	6.30	73.0	6.68	73.0	6.83	73.0	7.04	72.7	7.42
	7.3	5.0	76.8	6.21	76.5	6.57	76.1	6.92	76.1	7.10	75.8	7.28	75.8	7.64
	10.8	8.6	79.9	6.48	79.9	6.83	79.5	7.17	79.2	7.34	79.2	7.51	78.9	7.85
	14.4	12.2	83.7	6.77	83.3	7.10	83.0	7.42	83.0	7.59	83.0	7.75	82.6	8.07
	14.9	14.0	85.7	6.91	85.4	7.23	85.0	7.54	85.0	7.71	84.7	7.86	84.7	8.18
	16.7	15.6	87.4	7.03	87.1	7.34	87.1	7.66	86.7	7.81	86.7	7.96	86.4	8.28
	19.4	18.3	90.5	7.24	90.5	7.54	90.2	7.84	90.2	7.99	89.8	8.14	89.5	8.44
	23.0	21.9	95.3	7.51	95.0	7.65	94.6	8.08	94.6	8.23	94.3	8.36	94.3	8.65
	26.6	25.3	99.8	7.76	99.4	8.03	99.4	8.30	99.1	8.44	99.1	8.57	98.7	8.84
	32.0	30.7	107.7	8.14	107.7	8.39	107.3	8.64	107.3	8.76	107.0	8.89	107.0	9.13
	37.4	36.0	116.2	8.47	115.9	8.71	115.5	8.94	115.5	9.05	115.5	9.18	115.2	9.40
	41.0	39.4	122.1	8.69	121.7	8.91	121.7	9.12	121.4	9.24	121.4	9.35	121.0	9.56
	44.6	42.8	128.2	8.89	127.9	9.09	127.9	9.31	127.5	8.39	127.5	9.51	122.4	9.13
	48.2	46.2	134.7	9.07	134.4	9.28	134.4	9.47	134.1	9.57	131.3	9.38	122.4	8.58
	51.8	49.6	141.6	9.26	141.3	9.44	140.6	9.56	135.8	9.19	131.3	8.81	122.4	8.08
	55.4	53.2	149.1	9.43	148.8	9.61	140.6	8.96	135.8	8.60	131.3	8.27	122.4	7.59
59.0	56.7	156.3	9.59	149.5	9.10	140.6	8.44	135.8	8.12	131.3	7.79	122.4	7.16	
64.4	62.2	156.3	9.08	149.5	8.67	140.6	8.00	135.8	7.71	131.3	7.36	122.4	6.80	
68.0	65.3	156.3	8.65	149.5	8.28	140.6	7.64	135.8	7.36	131.3	6.99	122.4	6.49	
75.2	68.9	156.3	8.27	149.5	7.96	140.6	7.34	135.8	7.08	131.3	6.68	122.4	6.26	

Combination	Outdoor air temp.		Indoor air temperature											
			61		64		68		70		72		75	
	°FDB	°FWB	TC	PI	TC	PI	TC	PI	TC	PI	TC	PI	TC	PI
			KBtu/h	kW	KBtu/h	kW	KBtu/h	kW	KBtu/h	kW	KBtu/h	kW	KBtu/h	kW
120%	-3.6	-4.0	69.6	6.08	69.3	6.43	68.9	6.80	68.9	6.97	68.9	7.16	68.6	7.52
	-1.8	-2.2	70.6	6.19	70.3	6.55	70.3	6.83	69.9	7.08	69.9	7.26	69.6	7.62
	1.9	1.4	73.4	6.43	73.0	6.78	73.0	7.12	72.7	7.29	72.7	7.46	72.3	7.80
	7.3	5.0	76.5	6.69	76.1	7.01	75.8	7.34	75.8	7.51	75.8	7.68	75.4	8.00
	10.8	8.6	79.5	6.94	79.5	7.26	79.2	7.57	79.2	7.74	78.9	7.89	78.9	8.21
	14.4	12.2	83.3	7.21	83.0	7.50	83.0	7.81	82.6	7.96	82.6	8.11	82.3	8.42
	14.9	14.0	85.4	7.34	85.0	7.64	84.7	7.92	84.7	8.07	84.7	8.16	84.3	8.51
	16.7	15.6	87.1	7.45	86.7	7.74	86.7	8.02	86.4	8.17	86.4	8.32	86.1	8.60
	19.4	18.3	90.2	7.65	90.2	7.92	89.8	8.20	89.8	8.34	89.5	8.47	89.5	8.75
	23.0	21.9	95.0	7.89	94.6	8.16	94.3	8.42	94.3	8.55	94.3	8.69	93.9	8.94
	26.6	25.3	99.4	8.13	99.4	8.38	99.1	8.62	99.1	8.75	98.7	8.88	98.7	9.12
	32.0	30.7	107.3	8.47	107.3	8.71	107.0	9.04	107.0	9.05	106.6	9.17	106.6	9.40
	37.4	36.0	115.9	8.79	115.5	9.00	115.5	9.22	115.2	9.33	115.2	9.43	112.8	9.38
	41.0	39.4	121.7	8.98	121.4	9.19	121.4	9.39	121.0	9.49	121.0	9.59	112.8	8.81
	44.6	42.8	127.9	9.17	127.9	9.36	127.5	9.55	125.5	9.42	121.4	9.03	112.8	8.29
	48.2	46.2	134.4	9.35	134.1	9.53	129.6	9.22	125.5	8.85	121.4	8.49	112.8	7.80
	51.8	49.6	141.3	9.51	137.8	9.35	129.6	8.67	125.5	8.33	121.4	7.99	112.8	7.35
	55.4	53.2	146.4	9.42	137.8	8.77	129.6	8.13	125.5	7.82	121.4	7.51	112.8	6.91
	59.0	56.7	146.4	8.87	137.8	8.26	129.6	7.67	125.5	7.37	121.4	7.09	112.8	6.52
	64.4	62.2	146.4	8.38	137.8	7.82	129.6	7.28	125.5	6.98	121.4	6.71	112.8	6.19
68.0	65.3	146.4	7.94	137.8	7.46	129.6	6.96	125.5	6.66	121.4	6.39	112.8	5.89	
75.2	68.9	146.4	7.55	137.8	7.16	129.6	6.71	125.5	6.38	121.4	6.14	112.8	5.65	
110%	-3.6	-4.0	69.3	6.61	68.9	6.93	68.6	7.27	68.6	7.43	68.6	7.60	68.2	7.93
	-1.8	-2.2	70.3	6.71	70.3	7.03	69.9	7.36	69.9	7.52	69.6	7.69	69.6	8.01
	1.9	1.4	73.0	6.93	72.7	7.25	72.7	7.56	72.3	7.72	72.3	7.88	72.0	8.19
	7.3	5.0	76.1	7.17	75.8	7.47	75.4	7.77	75.4	7.92	75.4	8.07	75.1	8.37
	10.8	8.6	79.2	7.41	79.2	7.70	78.9	7.98	78.9	8.13	78.5	8.27	78.5	8.56
	14.4	12.2	83.0	7.65	82.6	7.92	82.6	8.20	82.3	8.34	82.3	8.47	82.3	8.75
	14.9	14.0	85.0	7.77	84.7	8.03	84.3	8.31	84.3	8.44	84.3	8.57	84.0	8.84
	16.7	15.6	86.7	7.87	86.4	8.14	86.4	8.40	86.4	8.53	86.1	8.67	86.1	8.92
	19.4	18.3	89.8	8.05	89.8	8.30	89.5	8.55	89.5	8.69	90.5	8.81	89.1	9.06
	23.0	21.9	94.6	8.28	94.3	8.52	93.9	8.76	93.9	8.88	98.4	9.00	93.6	9.25
	26.6	25.3	99.1	8.49	99.1	8.72	98.7	8.95	98.7	9.06	106.6	9.18	98.4	9.41
	32.0	30.7	107.0	8.81	107.0	9.02	106.6	9.24	106.6	9.34	111.1	9.45	103.5	9.27
	37.4	36.0	115.5	9.10	115.2	9.30	115.2	9.49	114.9	9.58	111.1	9.20	103.5	8.43
	41.0	39.4	121.4	9.28	121.4	9.47	119.0	9.38	114.9	9.00	111.1	8.65	103.5	7.93
	44.6	42.8	127.5	9.45	126.5	9.51	119.0	8.81	114.9	8.46	111.1	8.13	103.5	7.46
	48.2	46.2	134.1	9.60	126.5	8.94	119.0	8.29	114.9	7.96	111.1	7.65	103.5	7.03
	51.8	49.6	134.1	9.03	126.5	8.41	119.0	7.80	114.9	7.50	111.1	7.21	103.5	6.64
	55.4	53.2	134.1	8.47	126.5	7.89	119.0	7.33	114.9	7.05	111.1	6.78	103.5	6.25
	59.0	56.7	134.1	7.98	126.5	7.44	119.0	6.92	114.9	6.66	111.1	6.41	103.5	5.91
	64.4	62.2	134.1	7.55	126.5	7.05	119.0	6.31	114.9	6.31	111.1	6.11	103.5	5.63
68.0	65.3	134.1	7.17	126.5	6.71	119.0	5.98	114.9	6.00	111.1	5.85	103.5	5.38	
75.2	68.9	134.1	6.84	126.5	6.40	119.0	5.70	114.9	5.75	111.1	5.64	103.5	5.18	

GMV5 DC Inverter VRF Units Technical Sales Guide

Combination	Outdoor air temp.		Indoor air temperature											
			61		64		68		70		72		75	
	°FDB	°FWB	TC	PI	TC	PI	TC	PI	TC	PI	TC	PI	TC	PI
			KBtu/h	kW	KBtu/h	kW	KBtu/h	kW	KBtu/h	kW	KBtu/h	kW	KBtu/h	kW
100%	-3.6	-4.0	68.9	7.14	68.6	7.43	68.6	7.74	68.2	7.89	68.2	8.03	67.9	8.34
	-1.8	-2.2	69.9	7.23	69.9	7.52	69.6	7.82	69.6	7.97	69.3	8.13	69.3	8.42
	1.9	1.4	72.7	7.43	72.3	7.72	72.3	8.00	72.3	8.15	72.0	8.29	72.0	8.57
	7.3	5.0	75.8	7.65	75.4	7.92	75.4	8.20	75.1	8.34	75.1	8.47	74.7	8.75
	10.8	8.6	78.9	7.87	78.9	8.13	78.5	8.39	78.5	8.52	78.5	8.35	78.2	8.92
	14.4	12.2	82.6	8.08	82.3	8.34	82.3	8.58	82.3	8.72	81.9	8.84	81.9	9.08
	14.9	14.0	84.7	8.20	84.3	8.44	84.3	8.69	84.0	8.81	84.0	8.93	83.7	9.18
	16.7	15.6	86.4	8.29	86.4	8.53	86.1	8.77	86.1	8.89	85.7	9.01	85.7	9.25
	19.4	18.3	89.5	8.45	89.5	8.69	89.1	8.91	89.1	9.03	89.1	9.14	88.8	9.38
	23.0	21.9	94.3	8.67	93.9	8.88	93.9	9.10	93.6	9.22	93.6	9.32	93.6	9.54
	26.6	25.3	98.7	8.86	98.7	9.06	98.4	9.28	98.4	9.38	98.4	9.48	94.3	9.08
	32.0	30.7	106.6	9.16	106.6	9.34	106.3	9.53	104.6	9.38	101.1	8.99	94.3	8.26
	37.4	36.0	115.2	9.41	114.9	9.58	108.0	8.87	104.6	8.52	101.1	8.19	94.3	7.51
	41.0	39.4	121.0	9.58	114.9	9.00	108.0	8.34	104.6	8.02	101.1	7.71	94.3	7.09
	44.6	42.8	121.7	9.09	114.9	8.46	108.0	7.85	104.6	7.55	101.1	7.26	94.3	6.68
	48.2	46.2	121.7	8.54	114.9	7.96	108.0	7.39	104.6	7.12	101.1	6.84	94.3	6.30
	51.8	49.6	121.7	8.04	114.9	7.50	108.0	6.97	104.6	6.71	101.1	6.45	94.3	5.95
	55.4	53.2	121.7	7.55	114.9	7.05	108.0	6.57	104.6	6.32	101.1	6.09	94.3	5.62
	59.0	56.7	121.7	7.13	114.9	6.66	108.0	6.20	104.6	5.97	101.1	5.75	94.3	5.32
	64.4	62.2	121.7	6.72	114.9	6.35	108.0	5.99	104.6	5.67	101.1	5.44	94.3	5.07
68.0	65.3	121.7	6.34	114.9	6.10	108.0	5.75	104.6	5.41	101.1	5.19	94.3	4.86	
75.2	68.9	121.7	5.99	114.9	5.89	108.0	5.53	104.6	5.21	101.1	4.99	94.3	4.71	
90%	-3.6	-4.0	68.6	7.67	68.2	7.93	68.2	8.21	67.9	8.34	67.9	8.48	67.9	8.75
	-1.8	-2.2	69.6	7.75	69.6	8.02	69.3	8.29	69.3	8.42	69.3	8.55	68.9	8.82
	1.9	1.4	72.3	7.94	72.0	8.20	72.0	8.45	72.0	8.58	71.7	8.71	71.7	8.96
	7.3	5.0	75.4	8.14	75.1	8.38	75.1	8.62	74.7	8.67	74.7	8.87	74.7	9.11
	10.8	8.6	78.5	8.33	78.5	8.56	78.2	8.80	78.2	8.92	78.2	9.03	77.8	9.27
	14.4	12.2	82.3	8.52	82.3	8.75	81.9	8.97	81.9	9.09	81.9	9.21	81.6	9.43
	14.9	14.0	84.3	8.62	84.0	8.85	84.0	9.06	83.7	9.18	83.7	9.29	83.7	9.50
	16.7	15.6	86.1	8.72	86.1	8.93	85.7	9.14	85.7	9.25	85.7	9.36	84.7	9.45
	19.4	18.3	89.1	8.86	89.1	9.06	88.8	9.28	88.8	9.38	88.8	9.48	84.7	9.02
	23.0	21.9	93.9	9.05	93.6	9.25	93.6	9.44	93.6	9.54	90.9	9.25	84.7	8.48
	26.6	25.3	98.4	9.23	98.4	8.39	97.4	9.45	93.9	9.07	90.9	8.71	84.7	7.99
	32.0	30.7	106.6	9.49	103.5	8.24	97.4	8.57	93.9	8.24	90.9	7.91	84.7	7.27
	37.4	36.0	109.7	9.04	103.5	8.42	97.4	7.81	93.9	7.51	90.9	7.22	84.7	6.65
	41.0	39.4	109.7	8.50	103.5	7.92	97.4	7.36	93.9	7.08	90.9	6.81	84.7	6.27
	44.6	42.8	109.7	7.99	103.5	7.46	97.4	6.93	93.9	6.68	90.9	6.42	84.7	5.92
	48.2	46.2	109.7	7.53	103.5	7.02	97.4	6.53	93.9	6.30	90.9	6.07	84.7	5.60
	51.8	49.6	109.7	7.10	103.5	6.63	97.4	6.18	93.9	5.95	90.9	5.73	84.7	5.30
	55.4	53.2	109.7	6.68	103.5	6.25	97.4	5.82	93.9	5.62	90.9	5.41	84.7	5.01
	59.0	56.7	109.7	6.31	103.5	5.90	97.4	5.52	93.9	5.30	90.9	5.13	84.7	4.75
	64.4	62.2	109.7	5.96	103.5	5.58	97.4	5.23	93.9	5.01	90.9	4.86	84.7	4.52
68.0	65.3	109.7	5.64	103.5	5.27	97.4	4.96	93.9	4.72	90.9	4.62	84.7	4.31	
75.2	68.9	109.7	5.32	103.5	4.98	97.4	4.71	93.9	4.46	90.9	4.38	84.7	4.12	

Combination	Outdoor air temp.		Indoor air temperature											
			61		64		68		70		72		75	
	°FDB	°FWB	TC	PI	TC	PI	TC	PI	TC	PI	TC	PI	TC	PI
			KBtu/h	kW	KBtu/h	kW	KBtu/h	kW	KBtu/h	kW	KBtu/h	kW	KBtu/h	kW
80%	-3.6	-4.0	68.2	8.20	67.9	8.43	67.9	8.68	67.9	8.80	67.5	8.92	67.5	9.16
	-1.8	-2.2	69.3	8.27	69.3	8.51	68.9	8.75	68.9	8.87	68.9	8.98	68.6	9.23
	1.9	1.4	72.0	8.44	71.7	8.67	71.7	8.90	71.7	9.01	71.7	9.12	71.3	9.35
	7.3	5.0	75.1	8.61	74.7	8.83	74.7	9.05	74.7	9.16	74.4	9.27	74.4	9.49
	10.8	8.6	78.2	8.79	78.2	9.00	77.8	9.21	77.8	9.31	77.8	9.42	75.4	9.17
	14.4	12.2	81.9	8.96	81.9	9.17	81.6	9.37	81.6	9.46	80.9	9.44	75.4	8.66
	14.9	14.0	84.0	9.05	83.7	9.25	83.7	9.44	83.7	9.54	80.9	9.17	75.4	8.40
	16.7	15.6	85.7	9.13	85.7	9.33	85.4	9.51	83.7	9.31	80.9	8.92	75.4	8.18
	19.4	18.3	88.8	9.27	88.8	9.45	86.4	9.25	83.7	8.88	80.9	8.52	75.4	7.85
	23.0	21.9	93.6	8.41	91.9	9.38	86.4	8.69	83.7	8.35	80.9	8.01	75.4	7.36
	26.6	25.3	97.4	8.46	91.9	8.83	86.4	8.18	83.7	7.90	80.9	7.55	75.4	6.95
	32.0	30.7	97.4	8.60	91.9	8.01	86.4	7.44	83.7	7.17	80.9	6.88	75.4	6.34
	37.4	36.0	97.4	7.84	91.9	7.31	86.4	6.80	83.7	6.55	80.9	6.30	75.4	5.81
	41.0	39.4	97.4	7.38	91.9	6.89	86.4	6.41	83.7	6.18	80.9	5.95	75.4	5.50
	44.6	42.8	97.4	6.95	91.9	6.51	86.4	6.06	83.7	5.84	80.9	5.63	75.4	5.20
	48.2	46.2	97.4	6.57	91.9	6.14	86.4	5.75	83.7	5.52	80.9	5.32	75.4	4.92
	51.8	49.6	97.4	6.20	91.9	5.80	86.4	5.41	83.7	5.22	80.9	5.04	75.4	4.67
	55.4	53.2	97.4	5.84	91.9	5.47	86.4	5.12	83.7	4.93	80.9	4.76	75.4	4.41
	59.0	56.7	97.4	5.53	91.9	5.19	86.4	4.85	83.7	4.68	80.9	4.52	75.4	4.20
	64.4	62.2	97.4	5.27	91.9	4.93	86.4	4.62	83.7	4.45	80.9	4.28	75.4	4.01
68.0	65.3	97.4	5.07	91.9	4.73	86.4	4.41	83.7	4.24	80.9	4.08	75.4	3.82	
75.2	68.9	97.4	4.91	91.9	4.58	86.4	4.23	83.7	4.06	80.9	3.89	75.4	3.66	
70%	-3.6	-4.0	67.9	8.73	67.5	8.93	67.5	9.14	67.5	9.25	67.5	9.36	65.8	9.26
	-1.8	-2.2	68.9	8.80	68.9	9.00	68.6	9.21	68.6	9.31	68.6	9.42	65.8	9.06
	1.9	1.4	71.7	8.94	71.7	9.14	71.3	9.34	71.3	9.44	70.6	9.43	65.8	8.65
	7.3	5.0	74.7	9.09	74.4	9.29	74.4	9.48	73.0	9.00	70.6	8.96	65.8	8.22
	10.8	8.6	77.8	9.25	77.8	9.43	75.8	9.21	73.0	8.85	70.6	8.49	65.8	7.79
	14.4	12.2	81.6	9.40	80.6	9.39	75.8	8.70	73.0	8.36	70.6	8.02	65.8	7.37
	14.9	14.0	83.7	9.48	80.6	9.11	75.8	8.44	73.0	8.12	70.6	7.80	65.8	7.17
	16.7	15.6	85.4	9.53	80.6	8.87	75.8	8.22	73.0	7.90	70.6	7.60	65.8	6.98
	19.4	18.3	85.4	9.10	80.6	8.47	75.8	7.86	73.0	7.56	70.6	7.27	65.8	6.69
	23.0	21.9	85.4	8.55	80.6	7.97	75.8	7.40	73.0	7.12	70.6	6.84	65.8	6.31
	26.6	25.3	85.4	8.05	80.6	7.51	75.8	6.98	73.0	6.72	70.6	6.46	65.8	5.96
	32.0	30.7	85.4	7.33	80.6	6.88	75.8	6.37	73.0	6.14	70.6	5.91	65.8	5.46
	37.4	36.0	85.4	6.70	80.6	6.15	75.8	5.84	73.0	5.63	70.6	5.42	65.8	5.02
	41.0	39.4	85.4	6.32	80.6	5.91	75.8	5.53	73.0	5.32	70.6	5.14	65.8	4.75
	44.6	42.8	85.4	5.97	80.6	5.60	75.8	5.22	73.0	5.04	70.6	4.86	65.8	4.51
	48.2	46.2	85.4	5.65	80.6	5.29	75.8	4.94	73.0	4.77	70.6	4.61	65.8	4.27
	51.8	49.6	85.4	5.34	80.6	5.01	75.8	4.69	73.0	4.53	70.6	4.37	65.8	4.06
	55.4	53.2	85.4	5.05	80.6	4.74	75.8	4.43	73.0	4.29	70.6	4.14	65.8	3.85
	59.0	56.7	85.4	4.78	80.6	4.50	75.8	4.21	73.0	4.08	70.6	3.94	65.8	3.67
	64.4	62.2	85.4	4.54	80.6	4.27	75.8	4.01	73.0	3.88	70.6	3.75	65.8	3.51
68.0	65.3	85.4	4.32	80.6	4.07	75.8	3.82	73.0	3.71	70.6	3.59	65.8	3.36	
75.2	68.9	85.4	4.13	80.6	3.88	75.8	3.67	73.0	3.56	70.6	3.46	65.8	3.24	

GMV5 DC Inverter VRF Units Technical Sales Guide

Combination	Outdoor air temp.		Indoor air temperature											
			61		64		68		70		72		75	
	°FDB	°FWB	TC	PI	TC	PI	TC	PI	TC	PI	TC	PI	TC	PI
			KBtu/h	kW	KBtu/h	kW	KBtu/h	kW	KBtu/h	kW	KBtu/h	kW	KBtu/h	kW
60%	-3.6	-4.0	67.5	9.26	67.2	9.43	64.8	9.07	62.7	8.72	60.7	8.37	56.6	7.68
	-1.8	-2.2	68.6	9.32	68.6	9.49	64.8	8.88	62.7	8.53	60.7	8.19	56.6	7.51
	1.9	1.4	71.3	9.44	68.9	9.14	64.8	8.47	62.7	8.15	60.7	7.82	56.6	7.19
	7.3	5.0	73.0	9.34	68.9	8.69	64.8	8.05	62.7	7.75	60.7	7.44	56.6	6.84
	10.8	8.6	73.0	8.84	68.9	8.23	64.8	7.64	62.7	7.35	60.7	7.07	56.6	6.50
	14.4	12.2	73.0	8.35	68.9	7.78	64.8	7.23	62.7	6.95	60.7	6.69	56.6	6.17
	14.9	14.0	73.0	8.12	68.9	7.56	64.8	7.02	62.7	6.77	60.7	6.50	56.6	5.99
	16.7	15.6	73.0	7.90	68.9	7.37	64.8	6.85	62.7	6.60	60.7	6.34	56.6	5.85
	19.4	18.3	73.0	7.55	68.9	7.05	64.8	6.56	62.7	6.32	60.7	6.08	56.6	5.62
	23.0	21.9	73.0	7.12	68.9	6.65	64.8	6.19	62.7	5.96	60.7	5.74	56.6	5.31
	26.6	25.3	73.0	6.72	68.9	6.28	64.8	5.87	62.7	5.65	60.7	5.43	56.6	5.03
	32.0	30.7	73.0	6.14	68.9	5.75	64.8	5.36	62.7	5.18	60.7	4.99	56.6	4.62
	37.4	36.0	73.0	5.63	68.9	5.28	64.8	4.93	62.7	4.76	60.7	4.60	56.6	0.18
	41.0	39.4	73.0	5.32	68.9	5.00	64.8	4.67	62.7	4.52	60.7	4.35	56.6	4.05
	44.6	42.8	73.0	5.04	68.9	4.73	64.8	4.42	62.7	4.28	60.7	4.14	56.6	3.84
	48.2	46.2	73.0	4.77	68.9	4.49	64.8	4.20	62.7	4.07	60.7	3.93	56.6	3.66
	51.8	49.6	73.0	4.53	68.9	4.26	64.8	4.00	62.7	3.86	60.7	3.73	56.6	3.49
	55.4	53.2	73.0	4.28	68.9	4.04	64.8	3.79	62.7	3.67	60.7	3.55	56.6	3.31
	59.0	56.7	73.0	4.08	68.9	3.83	64.8	3.61	62.7	3.50	60.7	3.38	56.6	3.16
	64.4	62.2	73.0	3.89	68.9	3.65	64.8	3.45	62.7	3.34	60.7	3.24	56.6	3.03
68.0	65.3	73.0	3.73	68.9	3.49	64.8	3.30	62.7	3.21	60.7	3.12	56.6	2.92	
75.2	68.9	73.0	3.59	68.9	3.34	64.8	3.18	62.7	3.10	60.7	3.02	56.6	2.81	
50%	-3.6	-4.0	61.0	8.42	57.6	7.84	54.2	7.28	52.1	7.01	50.4	6.74	47.0	6.21
	-1.8	-2.2	61.0	8.24	57.6	7.68	54.2	7.14	52.1	6.86	50.4	6.60	47.0	6.09
	1.9	1.4	61.0	7.86	57.6	7.33	54.2	6.82	52.1	6.57	50.4	6.32	47.0	5.83
	7.3	5.0	61.0	7.48	57.6	6.98	54.2	6.49	52.1	6.26	50.4	6.03	47.0	5.57
	10.8	8.6	61.0	7.11	57.6	6.65	54.2	6.18	52.1	5.95	50.4	5.73	47.0	5.30
	14.4	12.2	61.0	6.73	57.6	6.29	54.2	5.86	52.1	5.65	50.4	5.44	47.0	5.04
	14.9	14.0	61.0	6.55	57.6	6.12	54.2	5.71	52.1	5.51	50.4	5.30	47.0	4.90
	16.7	15.6	61.0	6.38	57.6	5.97	54.2	5.57	52.1	5.37	50.4	5.18	47.0	4.79
	19.4	18.3	61.0	6.12	57.6	5.75	54.2	5.34	52.1	5.16	50.4	4.98	47.0	4.61
	23.0	21.9	61.0	5.77	57.6	5.41	54.2	5.06	52.1	4.88	50.4	4.71	47.0	4.36
	26.6	25.3	61.0	5.46	57.6	5.13	54.2	4.79	52.1	4.63	50.4	4.47	47.0	4.15
	32.0	30.7	61.0	5.02	57.6	4.71	54.2	4.41	52.1	4.26	50.4	4.12	47.0	3.83
	37.4	36.0	61.0	4.62	57.6	4.34	54.2	4.07	52.1	3.94	50.4	3.81	47.0	3.55
	41.0	39.4	61.0	4.38	57.6	4.12	54.2	3.86	52.1	3.74	50.4	3.62	47.0	3.37
	44.6	42.8	61.0	4.16	57.6	3.91	54.2	3.68	52.1	3.56	50.4	3.45	47.0	3.22
	48.2	46.2	61.0	3.95	57.6	3.72	54.2	3.50	52.1	3.39	50.4	3.28	47.0	3.07
	51.8	49.6	61.0	3.75	57.6	3.54	54.2	3.33	52.1	3.23	50.4	3.13	47.0	2.93
	55.4	53.2	61.0	3.57	57.6	3.36	54.2	3.17	52.1	3.08	50.4	2.98	47.0	2.79
	59.0	56.7	61.0	3.39	57.6	3.21	54.2	3.03	52.1	2.94	50.4	2.84	47.0	2.66
	64.4	62.2	61.0	3.23	57.6	3.07	54.2	2.91	52.1	2.81	50.4	2.72	47.0	2.54
68.0	65.3	61.0	3.08	57.6	2.94	54.2	2.79	52.1	2.71	50.4	2.61	47.0	2.43	
75.2	68.9	61.0	2.94	57.6	2.81	54.2	2.60	52.1	2.62	50.4	2.51	47.0	2.32	

GMV-120WM/B-F(U) GMV-120WM/B-U(U)

TC—Total capacity of outdoor unit; PI—Power input of outdoor unit

Combination	Outdoor air temp.		Indoor air temperature											
			61		64		68		70		72		75	
	°FDB	°FWB	TC	PI	TC	PI	TC	PI	TC	PI	TC	PI	TC	PI
			KBtu/h	kW	KBtu/h	kW	KBtu/h	kW	KBtu/h	kW	KBtu/h	kW	KBtu/h	kW
135%	-3.6	-4.0	87.4	7.42	87.0	7.94	86.6	8.47	86.6	8.73	86.1	8.99	86.1	9.52
	-1.8	-2.2	88.7	7.58	88.3	8.10	88.3	8.62	87.9	8.88	87.9	9.12	87.4	9.64
	1.9	1.4	92.1	7.94	91.7	8.43	91.3	8.93	91.3	9.14	91.3	9.42	90.9	9.93
	7.3	5.0	96.0	8.30	95.6	8.78	95.1	9.26	95.1	9.49	94.7	9.74	94.7	10.21
	10.8	8.6	99.9	8.67	99.9	9.14	99.4	9.59	99.0	9.82	99.0	10.05	98.6	10.50
	14.4	12.2	104.6	9.05	104.1	9.49	103.7	9.93	103.7	10.15	103.7	10.36	103.3	10.80
	14.9	14.0	107.1	9.25	106.7	9.67	106.3	10.09	106.3	10.31	105.9	10.51	105.9	10.94
	16.7	15.6	109.3	9.41	108.9	9.82	108.9	10.24	108.4	10.45	108.4	10.65	108.0	11.07
	19.4	18.3	113.1	9.68	113.1	10.09	112.7	10.49	112.7	10.69	112.3	10.88	111.9	11.29
	23.0	21.9	119.1	10.05	118.7	10.23	118.3	10.81	118.3	11.00	117.9	11.18	117.9	11.56
	26.6	25.3	124.7	10.38	124.3	10.75	124.3	11.10	123.9	11.29	123.9	11.47	123.4	11.82
	32.0	30.7	134.6	10.88	134.6	11.22	134.1	11.55	134.1	11.71	133.7	11.89	133.7	12.22
	37.4	36.0	145.3	11.33	144.9	11.65	144.4	11.96	144.4	12.11	144.4	12.27	144.0	12.57
	41.0	39.4	152.6	11.62	152.1	11.92	152.1	12.20	151.7	12.35	151.7	12.50	151.3	12.79
	44.6	42.8	160.3	11.89	159.9	12.16	159.9	12.45	159.4	11.22	159.4	12.72	153.0	12.22
	48.2	46.2	168.4	12.14	168.0	12.41	168.0	12.67	167.6	12.80	164.1	12.54	153.0	11.48
	51.8	49.6	177.0	12.38	176.6	12.63	175.7	12.79	169.7	12.29	164.1	11.78	153.0	10.81
	55.4	53.2	186.4	12.61	186.0	12.86	175.7	11.99	169.7	11.51	164.1	11.06	153.0	10.15
	59.0	56.7	195.4	12.83	186.9	12.18	175.7	11.29	169.7	10.85	164.1	10.42	153.0	9.57
	64.4	62.2	195.4	12.15	186.9	11.59	175.7	10.70	169.7	10.31	164.1	9.85	153.0	9.10
68.0	65.3	195.4	11.56	186.9	11.07	175.7	10.21	169.7	9.85	164.1	9.35	153.0	8.69	
75.2	68.9	195.4	11.06	186.9	10.65	175.7	9.82	169.7	9.46	164.1	8.93	153.0	8.37	
120%	-3.6	-4.0	87.0	8.13	86.6	8.60	86.1	9.10	86.1	9.33	86.1	9.57	85.7	10.06
	-1.8	-2.2	88.3	8.28	87.9	8.75	87.9	9.14	87.4	9.46	87.4	9.71	87.0	10.19
	1.9	1.4	91.7	8.60	91.3	9.07	91.3	9.52	90.9	9.75	90.9	9.98	90.4	10.43
	7.3	5.0	95.6	8.95	95.1	9.38	94.7	9.82	94.7	10.05	94.7	10.27	94.3	10.70
	10.8	8.6	99.4	9.29	99.4	9.71	99.0	10.13	99.0	10.35	98.6	10.55	98.6	10.98
	14.4	12.2	104.1	9.64	103.7	10.04	103.7	10.45	103.3	10.65	103.3	10.84	102.9	11.26
	14.9	14.0	106.7	9.82	106.3	10.21	105.9	10.60	105.9	10.80	105.9	10.91	105.4	11.39
	16.7	15.6	108.9	9.97	108.4	10.35	108.4	10.73	108.0	10.92	108.0	11.13	107.6	11.51
	19.4	18.3	112.7	10.23	112.7	10.60	112.3	10.96	112.3	11.15	111.9	11.33	111.9	11.70
	23.0	21.9	118.7	10.55	118.3	10.91	117.9	11.26	117.9	11.44	117.9	11.62	117.4	11.96
	26.6	25.3	124.3	10.87	124.3	11.21	123.9	11.54	123.9	11.70	123.4	11.88	123.4	12.20
	32.0	30.7	134.1	11.33	134.1	11.65	133.7	12.10	133.7	12.11	133.3	12.26	133.3	12.57
	37.4	36.0	144.9	11.75	144.4	12.04	144.4	12.33	144.0	12.48	144.0	12.61	141.0	12.55
	41.0	39.4	152.1	12.01	151.7	12.29	151.7	12.56	151.3	12.70	151.3	12.83	141.0	11.78
	44.6	42.8	159.9	12.26	159.9	12.52	159.4	12.78	156.9	12.60	151.7	12.08	141.0	11.09
	48.2	46.2	168.0	12.50	167.6	12.75	162.0	12.33	156.9	11.84	151.7	11.36	141.0	10.43
	51.8	49.6	176.6	12.72	172.3	12.50	162.0	11.59	156.9	11.14	151.7	10.69	141.0	9.83
	55.4	53.2	183.0	12.60	172.3	11.73	162.0	10.87	156.9	10.46	151.7	10.05	141.0	9.25
	59.0	56.7	183.0	11.86	172.3	11.05	162.0	10.25	156.9	9.86	151.7	9.48	141.0	8.73
	64.4	62.2	183.0	11.21	172.3	10.46	162.0	9.74	156.9	9.34	151.7	8.97	141.0	8.28
68.0	65.3	183.0	10.62	172.3	9.98	162.0	9.31	156.9	8.90	151.7	8.55	141.0	7.88	
75.2	68.9	183.0	10.10	172.3	9.57	162.0	8.97	156.9	8.54	151.7	8.21	141.0	7.55	

GMV5 DC Inverter VRF Units Technical Sales Guide

Combination	Outdoor air temp.		Indoor air temperature											
			61		64		68		70		72		75	
	°FDB	°FWB	TC	PI	TC	PI	TC	PI	TC	PI	TC	PI	TC	PI
			KBtu/h	kW	KBtu/h	kW	KBtu/h	kW	KBtu/h	kW	KBtu/h	kW	KBtu/h	kW
110%	-3.6	-4.0	86.6	8.84	86.1	9.27	85.7	9.72	85.7	9.94	85.7	10.16	85.3	10.61
	-1.8	-2.2	87.9	8.97	87.9	9.41	87.4	9.85	87.4	10.06	87.0	10.28	87.0	10.72
	1.9	1.4	91.3	9.27	90.9	9.70	90.9	10.12	90.4	10.32	90.4	10.54	90.0	10.95
	7.3	5.0	95.1	9.59	94.7	10.00	94.3	10.39	94.3	10.60	94.3	10.80	93.9	11.20
	10.8	8.6	99.0	9.91	99.0	10.30	98.6	10.68	98.6	10.87	98.1	11.06	98.1	11.45
	14.4	12.2	103.7	10.23	103.3	10.60	103.3	10.96	102.9	11.15	102.9	11.33	102.9	11.70
	14.9	14.0	106.3	10.39	105.9	10.75	105.4	11.11	105.4	11.29	105.4	11.47	105.0	11.82
	16.7	15.6	108.4	10.53	108.0	10.88	108.0	11.24	108.0	11.41	107.6	11.59	107.6	11.93
	19.4	18.3	112.3	10.77	112.3	11.10	111.9	11.44	111.9	11.62	113.1	11.78	111.4	12.12
	23.0	21.9	118.3	11.07	117.9	11.40	117.4	11.71	117.4	11.88	123.0	12.04	117.0	12.37
	26.6	25.3	123.9	11.36	123.9	11.66	123.4	11.97	123.4	12.12	133.3	12.27	123.0	12.59
	32.0	30.7	133.7	11.78	133.7	12.07	133.3	12.35	133.3	12.49	138.9	12.64	129.4	12.40
	37.4	36.0	144.4	12.18	144.0	12.44	144.0	12.70	143.6	12.82	138.9	12.30	129.4	11.28
	41.0	39.4	151.7	12.41	151.7	12.67	148.7	12.55	143.6	12.04	138.9	11.56	129.4	10.61
	44.6	42.8	159.4	12.64	158.1	12.72	148.7	11.78	143.6	11.32	138.9	10.87	129.4	9.98
	48.2	46.2	167.6	12.85	158.1	11.96	148.7	11.09	143.6	10.65	138.9	10.23	129.4	9.41
	51.8	49.6	167.6	12.08	158.1	11.25	148.7	10.43	143.6	10.04	138.9	9.64	129.4	8.88
	55.4	53.2	167.6	11.33	158.1	10.55	148.7	9.80	143.6	9.44	138.9	9.07	129.4	8.36
59.0	56.7	167.6	10.68	158.1	9.95	148.7	9.26	143.6	8.90	138.9	8.58	129.4	7.91	
64.4	62.2	167.6	10.10	158.1	9.44	148.7	8.44	143.6	8.44	138.9	8.17	129.4	7.53	
68.0	65.3	167.6	9.59	158.1	8.97	148.7	8.00	143.6	8.03	138.9	7.83	129.4	7.20	
75.2	68.9	167.6	9.15	158.1	8.56	148.7	7.62	143.6	7.69	138.9	7.54	129.4	6.93	
100%	-3.6	-4.0	86.1	9.55	85.7	9.94	85.7	10.35	85.3	10.55	85.3	10.75	84.9	11.15
	-1.8	-2.2	87.4	9.67	87.4	10.06	87.0	10.46	87.0	10.66	86.6	10.87	86.6	11.26
	1.9	1.4	90.9	9.94	90.4	10.32	90.4	10.70	90.4	10.90	90.0	11.09	90.0	11.47
	7.3	5.0	94.7	10.23	94.3	10.60	94.3	10.96	93.9	11.15	93.9	11.33	93.4	11.70
	10.8	8.6	98.6	10.53	98.6	10.87	98.1	11.22	98.1	11.40	98.1	11.17	97.7	11.93
	14.4	12.2	103.3	10.81	102.9	11.15	102.9	11.48	102.9	11.66	102.4	11.82	102.4	12.15
	14.9	14.0	105.9	10.96	105.4	11.29	105.4	11.62	105.0	11.78	105.0	11.95	104.6	12.27
	16.7	15.6	108.0	11.09	108.0	11.41	107.6	11.73	107.6	11.89	107.1	12.05	107.1	12.37
	19.4	18.3	111.9	11.30	111.9	11.62	111.4	11.92	111.4	12.08	111.4	12.23	111.0	12.55
	23.0	21.9	117.9	11.59	117.4	11.88	117.4	12.18	117.0	12.33	117.0	12.46	117.0	12.76
	26.6	25.3	123.4	11.85	123.4	12.12	123.0	12.41	123.0	12.55	123.0	12.68	117.9	12.15
	32.0	30.7	133.3	12.25	133.3	12.49	132.9	12.75	130.7	12.55	126.4	12.03	117.9	11.05
	37.4	36.0	144.0	12.59	143.6	12.82	135.0	11.86	130.7	11.40	126.4	10.95	117.9	10.05
	41.0	39.4	151.3	12.82	143.6	12.04	135.0	11.15	130.7	10.73	126.4	10.31	117.9	9.48
	44.6	42.8	152.1	12.16	143.6	11.32	135.0	10.50	130.7	10.10	126.4	9.71	117.9	8.93
	48.2	46.2	152.1	11.43	143.6	10.65	135.0	9.89	130.7	9.52	126.4	9.15	117.9	8.43
	51.8	49.6	152.1	10.76	143.6	10.04	135.0	9.33	130.7	8.97	126.4	8.63	117.9	7.96
	55.4	53.2	152.1	10.10	143.6	9.44	135.0	8.78	130.7	8.45	126.4	8.14	117.9	7.51
59.0	56.7	152.1	9.53	143.6	8.90	135.0	8.29	130.7	7.99	126.4	7.69	117.9	7.12	
64.4	62.2	152.1	8.99	143.6	8.50	135.0	8.02	130.7	7.58	126.4	7.28	117.9	6.78	
68.0	65.3	152.1	8.48	143.6	8.15	135.0	7.69	130.7	7.24	126.4	6.94	117.9	6.50	
75.2	68.9	152.1	8.02	143.6	7.88	135.0	7.39	130.7	6.97	126.4	6.67	117.9	6.30	

Combination	Outdoor air temp.		Indoor air temperature											
			61		64		68		70		72		75	
	°FDB	°FWB	TC	PI	TC	PI	TC	PI	TC	PI	TC	PI	TC	PI
			KBtu/h	kW	KBtu/h	kW	KBtu/h	kW	KBtu/h	kW	KBtu/h	kW	KBtu/h	kW
90%	-3.6	-4.0	85.7	10.25	85.3	10.61	85.3	10.98	84.9	11.15	84.9	11.35	84.9	11.70
	-1.8	-2.2	87.0	10.36	87.0	10.73	86.6	11.09	86.6	11.26	86.6	11.44	86.1	11.80
	1.9	1.4	90.4	10.62	90.0	10.96	90.0	11.30	90.0	11.48	89.6	11.65	89.6	11.99
	7.3	5.0	94.3	10.88	93.9	11.21	93.9	11.54	93.4	11.59	93.4	11.86	93.4	12.19
	10.8	8.6	98.1	11.14	98.1	11.45	97.7	11.77	97.7	11.93	97.7	12.08	97.3	12.40
	14.4	12.2	102.9	11.40	102.9	11.70	102.4	12.00	102.4	12.16	102.4	12.31	102.0	12.61
	14.9	14.0	105.4	11.54	105.0	11.84	105.0	12.12	104.6	12.27	104.6	12.42	104.6	12.71
	16.7	15.6	107.6	11.66	107.6	11.95	107.1	12.23	107.1	12.37	107.1	12.52	105.9	12.64
	19.4	18.3	111.4	11.85	111.4	12.12	111.0	12.41	111.0	12.55	111.0	12.68	105.9	12.07
	23.0	21.9	117.4	12.11	117.0	12.37	117.0	12.63	117.0	12.76	113.6	12.37	105.9	11.35
	26.6	25.3	123.0	12.34	123.0	11.22	121.7	12.64	117.4	12.14	113.6	11.65	105.9	10.69
	32.0	30.7	133.3	12.70	129.4	11.02	121.7	11.47	117.4	11.02	113.6	10.58	105.9	9.72
	37.4	36.0	137.1	12.10	129.4	11.26	121.7	10.45	117.4	10.05	113.6	9.65	105.9	8.89
	41.0	39.4	137.1	11.37	129.4	10.60	121.7	9.85	117.4	9.46	113.6	9.11	105.9	8.39
	44.6	42.8	137.1	10.69	129.4	9.98	121.7	9.27	117.4	8.93	113.6	8.59	105.9	7.92
	48.2	46.2	137.1	10.08	129.4	9.40	121.7	8.74	117.4	8.43	113.6	8.11	105.9	7.49
	51.8	49.6	137.1	9.49	129.4	8.86	121.7	8.26	117.4	7.96	113.6	7.66	105.9	7.09
	55.4	53.2	137.1	8.93	129.4	8.36	121.7	7.79	117.4	7.51	113.6	7.24	105.9	6.70
	59.0	56.7	137.1	8.44	129.4	7.90	121.7	7.38	117.4	7.09	113.6	6.86	105.9	6.35
	64.4	62.2	137.1	7.98	129.4	7.46	121.7	7.00	117.4	6.70	113.6	6.50	105.9	6.04
68.0	65.3	137.1	7.54	129.4	7.05	121.7	6.64	117.4	6.31	113.6	6.18	105.9	5.77	
75.2	68.9	137.1	7.12	129.4	6.65	121.7	6.30	117.4	5.96	113.6	5.86	105.9	5.51	
80%	-3.6	-4.0	85.3	10.96	84.9	11.28	84.9	11.60	84.9	11.77	84.4	11.93	84.4	12.25
	-1.8	-2.2	86.6	11.06	86.6	11.39	86.1	11.70	86.1	11.86	86.1	12.01	85.7	12.34
	1.9	1.4	90.0	11.29	89.6	11.59	89.6	11.90	89.6	12.05	89.6	12.20	89.1	12.50
	7.3	5.0	93.9	11.52	93.4	11.81	93.4	12.11	93.4	12.25	93.0	12.40	93.0	12.70
	10.8	8.6	97.7	11.75	97.7	12.04	97.3	12.31	97.3	12.45	97.3	12.60	94.3	12.26
	14.4	12.2	102.4	11.99	102.4	12.26	102.0	12.53	102.0	12.65	101.1	12.63	94.3	11.58
	14.9	14.0	105.0	12.11	104.6	12.37	104.6	12.63	104.6	12.76	101.1	12.26	94.3	11.24
	16.7	15.6	107.1	12.22	107.1	12.48	106.7	12.72	104.6	12.45	101.1	11.93	94.3	10.94
	19.4	18.3	111.0	12.40	111.0	12.64	108.0	12.37	104.6	11.88	101.1	11.40	94.3	10.50
	23.0	21.9	117.0	11.25	114.9	12.55	108.0	11.62	104.6	11.17	101.1	10.72	94.3	9.85
	26.6	25.3	121.7	11.32	114.9	11.81	108.0	10.94	104.6	10.57	101.1	10.10	94.3	9.30
	32.0	30.7	121.7	11.51	114.9	10.72	108.0	9.95	104.6	9.59	101.1	9.20	94.3	8.48
	37.4	36.0	121.7	10.49	114.9	9.78	108.0	9.10	104.6	8.75	101.1	8.43	94.3	7.77
	41.0	39.4	121.7	9.87	114.9	9.22	108.0	8.58	104.6	8.26	101.1	7.96	94.3	7.35
	44.6	42.8	121.7	9.30	114.9	8.71	108.0	8.10	104.6	7.81	101.1	7.53	94.3	6.95
	48.2	46.2	121.7	8.78	114.9	8.21	108.0	7.69	104.6	7.38	101.1	7.12	94.3	6.59
	51.8	49.6	121.7	8.29	114.9	7.76	108.0	7.24	104.6	6.98	101.1	6.74	94.3	6.25
	55.4	53.2	121.7	7.81	114.9	7.32	108.0	6.85	104.6	6.60	101.1	6.37	94.3	5.90
	59.0	56.7	121.7	7.39	114.9	6.94	108.0	6.49	104.6	6.26	101.1	6.04	94.3	5.62
	64.4	62.2	121.7	7.05	114.9	6.60	108.0	6.18	104.6	5.95	101.1	5.73	94.3	5.36
68.0	65.3	121.7	6.78	114.9	6.33	108.0	5.90	104.6	5.67	101.1	5.45	94.3	5.11	
75.2	68.9	121.7	6.57	114.9	6.12	108.0	5.66	104.6	5.43	101.1	5.21	94.3	4.90	

GMV5 DC Inverter VRF Units Technical Sales Guide

Combination	Outdoor air temp.		Indoor air temperature											
			61		64		68		70		72		75	
	°FDB	°FWB	TC	PI	TC	PI	TC	PI	TC	PI	TC	PI	TC	PI
			KBtu/h	kW	KBtu/h	kW	KBtu/h	kW	KBtu/h	kW	KBtu/h	kW	KBtu/h	kW
70%	-3.6	-4.0	84.9	11.67	84.4	11.95	84.4	12.23	84.4	12.37	84.4	12.52	82.3	12.38
	-1.8	-2.2	86.1	11.77	86.1	12.04	85.7	12.31	85.7	12.45	85.7	12.60	82.3	12.12
	1.9	1.4	89.6	11.96	89.6	12.23	89.1	12.49	89.1	12.63	88.3	12.61	82.3	11.56
	7.3	5.0	93.4	12.16	93.0	12.42	93.0	12.68	91.3	121.58	88.3	11.99	82.3	10.99
	10.8	8.6	97.3	12.37	97.3	12.61	94.7	12.31	91.3	11.84	88.3	11.36	82.3	10.42
	14.4	12.2	102.0	12.57	100.7	12.56	94.7	11.63	91.3	11.18	88.3	10.73	82.3	9.86
	14.9	14.0	104.6	12.68	100.7	12.19	94.7	11.29	91.3	10.85	88.3	10.43	82.3	9.59
	16.7	15.6	106.7	12.75	100.7	11.86	94.7	10.99	91.3	10.57	88.3	10.16	82.3	9.34
	19.4	18.3	106.7	12.18	100.7	11.33	94.7	10.51	91.3	10.12	88.3	9.72	82.3	8.95
	23.0	21.9	106.7	11.44	100.7	10.66	94.7	9.90	91.3	9.52	88.3	9.15	82.3	8.44
	26.6	25.3	106.7	10.77	100.7	10.05	94.7	9.34	91.3	8.99	88.3	8.65	82.3	7.98
	32.0	30.7	106.7	9.80	100.7	9.20	94.7	8.52	91.3	8.21	88.3	7.91	82.3	7.31
	37.4	36.0	106.7	8.96	100.7	0.20	94.7	7.81	91.3	7.53	88.3	7.25	82.3	6.71
	41.0	39.4	106.7	8.45	100.7	7.91	94.7	7.39	91.3	7.12	88.3	6.87	82.3	6.35
	44.6	42.8	106.7	7.99	100.7	7.49	94.7	6.98	91.3	6.74	88.3	6.50	82.3	6.03
	48.2	46.2	106.7	7.55	100.7	7.08	94.7	6.61	91.3	6.38	88.3	6.16	82.3	5.71
	51.8	49.6	106.7	7.15	100.7	6.70	94.7	6.27	91.3	6.05	88.3	5.85	82.3	5.43
	55.4	53.2	106.7	6.75	100.7	6.34	94.7	5.93	91.3	5.74	88.3	5.54	82.3	5.15
	59.0	56.7	106.7	6.40	100.7	6.01	94.7	5.63	91.3	5.45	88.3	5.26	82.3	4.91
64.4	62.2	106.7	6.07	100.7	5.71	94.7	5.36	91.3	5.20	88.3	5.02	82.3	4.69	
68.0	65.3	106.7	5.78	100.7	5.44	94.7	5.11	91.3	4.96	88.3	4.80	82.3	4.50	
75.2	68.9	106.7	5.52	100.7	5.20	94.7	4.91	91.3	4.76	88.3	4.62	82.3	4.34	
60%	-3.6	-4.0	84.4	12.38	84.0	12.61	81.0	12.14	78.4	11.66	75.9	11.20	70.7	10.27
	-1.8	-2.2	85.7	12.46	85.7	12.70	81.0	11.88	78.4	11.41	75.9	10.95	70.7	10.05
	1.9	1.4	89.1	12.63	86.1	12.23	81.0	11.33	78.4	10.90	75.9	10.46	70.7	9.61
	7.3	5.0	91.3	12.49	86.1	11.62	81.0	10.77	78.4	10.36	75.9	9.95	70.7	9.15
	10.8	8.6	91.3	11.82	86.1	11.00	81.0	10.21	78.4	9.83	75.9	9.45	70.7	8.70
	14.4	12.2	91.3	11.17	86.1	10.40	81.0	9.67	78.4	9.30	75.9	8.95	70.7	8.25
	14.9	14.0	91.3	10.85	86.1	10.12	81.0	9.40	78.4	9.05	75.9	8.70	70.7	8.02
	16.7	15.6	91.3	10.57	86.1	9.86	81.0	9.16	78.4	8.82	75.9	8.48	70.7	7.83
	19.4	18.3	91.3	10.10	86.1	9.44	81.0	8.77	78.4	8.45	75.9	8.13	70.7	7.51
	23.0	21.9	91.3	9.52	86.1	8.89	81.0	8.28	78.4	7.98	75.9	7.68	70.7	7.10
	26.6	25.3	91.3	8.99	86.1	8.40	81.0	7.85	78.4	7.55	75.9	7.27	70.7	6.72
	32.0	30.7	91.3	8.21	86.1	7.69	81.0	7.17	78.4	6.93	75.9	6.67	70.7	6.18
	37.4	36.0	91.3	7.53	86.1	7.06	81.0	6.60	78.4	6.37	75.9	6.15	70.7	0.25
	41.0	39.4	91.3	7.12	86.1	6.68	81.0	6.25	78.4	6.04	75.9	5.82	70.7	5.41
	44.6	42.8	91.3	6.74	86.1	6.33	81.0	5.92	78.4	5.73	75.9	5.54	70.7	5.14
	48.2	46.2	91.3	6.38	86.1	6.00	81.0	5.62	78.4	5.44	75.9	5.25	70.7	4.90
	51.8	49.6	91.3	6.05	86.1	5.70	81.0	5.35	78.4	5.17	75.9	4.99	70.7	4.66
	55.4	53.2	91.3	5.73	86.1	5.40	81.0	5.07	78.4	4.91	75.9	4.75	70.7	4.43
	59.0	56.7	91.3	5.45	86.1	5.13	81.0	4.83	78.4	4.68	75.9	4.53	70.7	4.23
64.4	62.2	91.3	5.21	86.1	4.88	81.0	4.61	78.4	4.47	75.9	4.34	70.7	4.05	
68.0	65.3	91.3	4.99	86.1	4.66	81.0	4.42	78.4	4.30	75.9	4.17	70.7	3.90	
75.2	68.9	91.3	4.80	86.1	4.47	81.0	4.25	78.4	4.15	75.9	4.04	70.7	3.76	

Combination	Outdoor air temp.		Indoor air temperature											
			61		64		68		70		72		75	
	°FDB	°FWB	TC	PI	TC	PI	TC	PI	TC	PI	TC	PI	TC	PI
			KBtu/h	kW	KBtu/h	kW	KBtu/h	kW	KBtu/h	kW	KBtu/h	kW	KBtu/h	kW
50%	-3.6	-4.0	76.3	11.26	72.0	10.49	67.7	9.74	65.1	9.38	63.0	9.01	58.7	8.30
	-1.8	-2.2	76.3	11.02	72.0	10.27	67.7	9.55	65.1	9.18	63.0	8.82	58.7	8.14
	1.9	1.4	76.3	10.51	72.0	9.80	67.7	9.12	65.1	8.78	63.0	8.45	58.7	7.80
	7.3	5.0	76.3	10.01	72.0	9.34	67.7	8.69	65.1	8.37	63.0	8.06	58.7	7.45
	10.8	8.6	76.3	9.50	72.0	8.89	67.7	8.26	65.1	7.96	63.0	7.66	58.7	7.09
	14.4	12.2	76.3	9.00	72.0	8.41	67.7	7.84	65.1	7.55	63.0	7.28	58.7	6.74
	14.9	14.0	76.3	8.75	72.0	8.18	67.7	7.64	65.1	7.36	63.0	7.09	58.7	6.56
	16.7	15.6	76.3	8.54	72.0	7.99	67.7	7.45	65.1	7.19	63.0	6.93	58.7	6.41
	19.4	18.3	76.3	8.18	72.0	7.69	67.7	7.15	65.1	6.90	63.0	6.65	58.7	6.16
	23.0	21.9	76.3	7.72	72.0	7.24	67.7	6.76	65.1	6.53	63.0	6.30	58.7	5.84
	26.6	25.3	76.3	7.31	72.0	6.86	67.7	6.41	65.1	6.19	63.0	5.97	58.7	5.55
	32.0	30.7	76.3	6.71	72.0	6.30	67.7	5.90	65.1	5.70	63.0	5.51	58.7	5.13
	37.4	36.0	76.3	6.18	72.0	5.81	67.7	5.44	65.1	5.26	63.0	5.10	58.7	4.75
	41.0	39.4	76.3	5.86	72.0	5.51	67.7	5.17	65.1	5.00	63.0	4.84	58.7	4.51
	44.6	42.8	76.3	5.56	72.0	5.24	67.7	4.92	65.1	4.76	63.0	4.61	58.7	4.31
	48.2	46.2	76.3	5.28	72.0	4.98	67.7	4.68	65.1	4.54	63.0	4.39	58.7	4.10
	51.8	49.6	76.3	5.02	72.0	4.73	67.7	4.46	65.1	4.32	63.0	4.19	58.7	3.91
	55.4	53.2	76.3	4.77	72.0	4.50	67.7	4.24	65.1	4.12	63.0	3.98	58.7	3.74
59.0	56.7	76.3	4.54	72.0	4.30	67.7	4.05	65.1	3.93	63.0	3.80	58.7	3.56	
64.4	62.2	76.3	4.32	72.0	4.10	67.7	3.89	65.1	3.76	63.0	3.64	58.7	3.40	
68.0	65.3	76.3	4.12	72.0	3.93	67.7	3.74	65.1	3.63	63.0	3.49	58.7	3.25	
75.2	68.9	76.3	3.93	72.0	3.76	67.7	3.48	65.1	3.50	63.0	3.35	58.7	3.11	

GMV-144WM/B1-F(U)

TC—Total capacity of outdoor unit; PI—Power input of outdoor unit

Combination	Outdoor air temp.		Indoor air temperature											
			61		64		68		70		72		75	
	°FDB	°FWB	TC	PI	TC	PI	TC	PI	TC	PI	TC	PI	TC	PI
			KBtu/h	kW	KBtu/h	kW	KBtu/h	kW	KBtu/h	kW	KBtu/h	kW	KBtu/h	kW
135%	-3.6	-4.0	104.9	8.83	104.4	9.45	103.9	10.08	103.9	10.39	103.4	10.70	103.4	11.33
	-1.8	-2.2	106.5	9.03	105.9	9.64	105.9	10.26	105.4	10.57	105.4	10.86	104.9	11.48
	1.9	1.4	110.6	9.45	110.1	10.03	109.5	10.63	109.5	10.88	109.5	11.22	109.0	11.82
	7.3	5.0	115.2	9.89	114.7	10.45	114.2	11.02	114.2	11.30	113.7	11.59	113.7	12.16
	10.8	8.6	119.8	10.32	119.8	10.88	119.3	11.41	118.8	11.69	118.8	11.96	118.3	12.50
	14.4	12.2	125.5	10.78	125.0	11.30	124.5	11.82	124.5	12.08	124.5	12.34	123.9	12.86
	14.9	14.0	128.6	11.01	128.1	11.51	127.5	12.01	127.5	12.27	127.0	12.52	127.0	13.02
	16.7	15.6	131.1	11.20	130.6	11.69	130.6	12.19	130.1	12.44	130.1	12.68	129.6	13.18
	19.4	18.3	135.8	11.53	135.8	12.01	135.3	12.48	135.3	12.73	134.7	12.95	134.2	13.44
	23.0	21.9	143.0	11.96	142.5	12.18	141.9	12.87	141.9	13.10	141.4	13.31	141.4	13.77
	26.6	25.3	149.7	12.35	149.1	12.79	149.1	13.21	148.6	13.44	148.6	13.65	148.1	14.07
	32.0	30.7	161.5	12.95	161.5	13.36	161.0	13.75	161.0	13.94	160.5	14.16	160.5	14.55
	37.4	36.0	174.3	13.49	173.8	13.86	173.3	14.24	173.3	14.42	173.3	14.61	172.8	14.97
	41.0	39.4	183.1	13.83	182.6	14.19	182.6	14.53	182.1	14.71	182.1	14.89	181.5	15.23
	44.6	42.8	192.3	14.16	191.8	14.48	191.8	14.82	191.3	13.36	191.3	15.15	183.6	14.55
	48.2	46.2	202.1	14.45	201.6	14.77	201.6	15.08	201.1	15.24	197.0	14.93	183.6	13.67
	51.8	49.6	212.4	14.74	211.9	15.03	210.9	15.23	203.7	14.63	197.0	14.03	183.6	12.87
	55.4	53.2	223.7	15.02	223.2	15.31	210.9	14.27	203.7	13.70	197.0	13.17	183.6	12.08
59.0	56.7	234.5	15.28	224.2	14.50	210.9	13.44	203.7	12.92	197.0	12.40	183.6	11.40	
64.4	62.2	234.5	14.46	224.2	13.80	210.9	12.74	203.7	12.27	197.0	11.72	183.6	10.83	
68.0	65.3	234.5	13.77	224.2	13.18	210.9	12.16	203.7	11.72	197.0	11.14	183.6	10.34	
75.2	68.9	234.5	13.17	224.2	12.68	210.9	11.69	203.7	11.27	197.0	10.63	183.6	9.97	

GMV5 DC Inverter VRF Units Technical Sales Guide

Combination	Outdoor air temp.		Indoor air temperature											
			61		64		68		70		72		75	
	°FDB	°FWB	TC	PI	TC	PI	TC	PI	TC	PI	TC	PI	TC	PI
			KBtu/h	kW	KBtu/h	kW	KBtu/h	kW	KBtu/h	kW	KBtu/h	kW	KBtu/h	kW
120%	-3.6	-4.0	104.4	9.68	103.9	10.24	103.4	10.83	103.4	11.10	103.4	11.40	102.9	11.98
	-1.8	-2.2	105.9	9.85	105.4	10.42	105.4	10.88	104.9	11.27	104.9	11.56	104.4	12.13
	1.9	1.4	110.1	10.24	109.5	10.80	109.5	11.33	109.0	11.61	109.0	11.88	108.5	12.42
	7.3	5.0	114.7	10.65	114.2	11.17	113.7	11.69	113.7	11.96	113.7	12.22	113.1	12.74
	10.8	8.6	119.3	11.06	119.3	11.56	118.8	12.06	118.8	12.32	118.3	12.56	118.3	13.07
	14.4	12.2	125.0	11.48	124.5	11.95	124.5	12.44	123.9	12.68	123.9	12.91	123.4	13.41
	14.9	14.0	128.1	11.69	127.5	12.16	127.0	12.61	127.0	12.86	127.0	12.99	126.5	13.56
	16.7	15.6	130.6	11.87	130.1	12.32	130.1	12.78	129.6	13.00	129.6	13.25	129.1	13.70
	19.4	18.3	135.3	12.18	135.3	12.61	134.7	13.05	134.7	13.28	134.2	13.49	134.2	13.93
	23.0	21.9	142.5	12.56	141.9	12.99	141.4	13.41	141.4	13.62	141.4	13.83	140.9	14.24
	26.6	25.3	149.1	12.94	149.1	13.34	148.6	13.73	148.6	13.93	148.1	14.14	148.1	14.53
	32.0	30.7	161.0	13.49	161.0	13.86	160.5	14.40	160.5	14.42	159.9	14.59	159.9	14.97
	37.4	36.0	173.8	13.99	173.3	14.33	173.3	14.68	172.8	14.85	172.8	15.02	169.2	14.94
	41.0	39.4	182.6	14.30	182.1	14.63	182.1	14.95	181.5	15.11	181.5	15.28	169.2	14.03
	44.6	42.8	191.8	14.59	191.8	14.90	191.3	15.21	188.2	15.00	182.1	14.38	169.2	13.20
	48.2	46.2	201.6	14.89	201.1	15.18	194.4	14.68	188.2	14.09	182.1	13.52	169.2	12.42
	51.8	49.6	211.9	15.15	206.7	14.89	194.4	13.80	188.2	13.26	182.1	12.73	169.2	11.70
	55.4	53.2	219.6	15.00	206.7	13.96	194.4	12.94	188.2	12.45	182.1	11.96	169.2	11.01
	59.0	56.7	219.6	14.12	206.7	13.15	194.4	12.21	188.2	11.74	182.1	11.28	169.2	10.39
	64.4	62.2	219.6	13.34	206.7	12.45	194.4	11.59	188.2	11.12	182.1	10.68	169.2	9.85
68.0	65.3	219.6	12.65	206.7	11.88	194.4	11.09	188.2	10.60	182.1	10.18	169.2	9.38	
75.2	68.9	219.6	12.03	206.7	11.40	194.4	10.68	188.2	10.16	182.1	9.77	169.2	8.99	
110%	-3.6	-4.0	103.9	10.52	103.4	11.04	102.9	11.57	102.9	11.83	102.9	12.09	102.3	12.63
	-1.8	-2.2	105.4	10.68	105.4	11.20	104.9	11.72	104.9	11.98	104.4	12.24	104.4	12.76
	1.9	1.4	109.5	11.04	109.0	11.54	109.0	12.05	108.5	12.29	108.5	12.55	108.0	13.04
	7.3	5.0	114.2	11.41	113.7	11.90	113.1	12.37	113.1	12.61	113.1	12.86	112.6	13.33
	10.8	8.6	118.8	11.80	118.8	12.26	118.3	12.71	118.3	12.94	117.8	13.17	117.8	13.64
	14.4	12.2	124.5	12.18	123.9	12.61	123.9	13.05	123.4	13.28	123.4	13.49	123.4	13.93
	14.9	14.0	127.5	12.37	127.0	12.79	126.5	13.23	126.5	13.44	126.5	13.65	126.0	14.07
	16.7	15.6	130.1	12.53	129.6	12.95	129.6	13.38	129.6	13.59	129.1	13.80	129.1	14.20
	19.4	18.3	134.7	12.82	134.7	13.21	134.2	13.62	134.2	13.83	135.8	14.03	133.7	14.43
	23.0	21.9	141.9	13.18	141.4	13.57	140.9	13.94	140.9	14.14	147.6	14.33	140.4	14.72
	26.6	25.3	148.6	13.52	148.6	13.88	148.1	14.25	148.1	14.43	159.9	14.61	147.6	14.98
	32.0	30.7	160.5	14.03	160.5	14.37	159.9	14.71	159.9	14.87	166.6	15.05	155.3	14.76
	37.4	36.0	173.3	14.50	172.8	14.81	172.8	15.11	172.3	15.26	166.6	14.64	155.3	13.43
	41.0	39.4	182.1	14.77	182.1	15.08	178.5	14.94	172.3	14.33	166.6	13.77	155.3	12.63
	44.6	42.8	191.3	15.05	189.8	15.15	178.5	14.03	172.3	13.47	166.6	12.94	155.3	11.88
	48.2	46.2	201.1	15.29	189.8	14.24	178.5	13.20	172.3	12.68	166.6	12.18	155.3	11.20
	51.8	49.6	201.1	14.38	189.8	13.39	178.5	12.42	172.3	11.95	166.6	11.48	155.3	10.57
55.4	53.2	201.1	13.49	189.8	12.56	178.5	11.67	172.3	11.23	166.6	10.80	155.3	9.95	
59.0	56.7	201.1	12.71	189.8	11.85	178.5	11.02	172.3	10.60	166.6	10.21	155.3	9.42	
64.4	62.2	201.1	12.03	189.8	11.23	178.5	10.05	172.3	10.05	166.6	9.72	155.3	8.96	
68.0	65.3	201.1	11.41	189.8	10.68	178.5	9.53	172.3	9.56	166.6	9.32	155.3	8.57	
75.2	68.9	201.1	10.89	189.8	10.19	178.5	9.07	172.3	9.16	166.6	8.98	155.3	8.25	

Combination	Outdoor air temp.		Indoor air temperature											
			61		64		68		70		72		75	
	°FDB	°FWB	TC	PI	TC	PI	TC	PI	TC	PI	TC	PI	TC	PI
			KBtu/h	kW	KBtu/h	kW	KBtu/h	kW	KBtu/h	kW	KBtu/h	kW	KBtu/h	kW
100%	-3.6	-4.0	103.4	11.36	102.9	11.83	102.9	12.32	102.3	12.56	102.3	12.79	101.8	13.28
	-1.8	-2.2	104.9	11.51	104.9	11.98	104.4	12.45	104.4	12.69	103.9	12.94	103.9	13.41
	1.9	1.4	109.0	11.83	108.5	12.29	108.5	12.74	108.5	12.97	108.0	13.20	108.0	13.65
	7.3	5.0	113.7	12.18	113.1	12.61	113.1	13.05	112.6	13.28	112.6	13.49	112.1	13.93
	10.8	8.6	118.3	12.53	118.3	12.94	117.8	13.36	117.8	13.57	117.8	13.30	117.3	14.20
	14.4	12.2	123.9	12.87	123.4	13.28	123.4	13.67	123.4	13.88	122.9	14.07	122.9	14.46
	14.9	14.0	127.0	13.05	126.5	13.44	126.5	13.83	126.0	14.03	126.0	14.22	125.5	14.61
	16.7	15.6	129.6	13.20	129.6	13.59	129.1	13.96	129.1	14.16	128.6	14.35	128.6	14.72
	19.4	18.3	134.2	13.46	134.2	13.83	133.7	14.19	133.7	14.38	133.7	14.56	133.2	14.94
	23.0	21.9	141.4	13.80	140.9	14.14	140.9	14.50	140.4	14.68	140.4	14.84	140.4	15.19
	26.6	25.3	148.1	14.11	148.1	14.43	147.6	14.77	147.6	14.94	147.6	15.10	141.4	14.46
	32.0	30.7	159.9	14.58	159.9	14.87	159.4	15.18	156.9	14.94	151.7	14.32	141.4	13.15
	37.4	36.0	172.8	14.98	172.3	15.26	162.0	14.12	156.9	13.57	151.7	13.04	141.4	11.96
	41.0	39.4	181.5	15.26	172.3	14.33	162.0	13.28	156.9	12.78	151.7	12.27	141.4	11.28
	44.6	42.8	182.6	14.48	172.3	13.47	162.0	12.50	156.9	12.03	151.7	11.56	141.4	10.63
	48.2	46.2	182.6	13.60	172.3	12.68	162.0	11.77	156.9	11.33	151.7	10.89	141.4	10.03
	51.8	49.6	182.6	12.81	172.3	11.95	162.0	11.10	156.9	10.68	151.7	10.28	141.4	9.48
	55.4	53.2	182.6	12.03	172.3	11.23	162.0	10.45	156.9	10.06	151.7	9.69	141.4	8.94
	59.0	56.7	182.6	11.35	172.3	10.60	162.0	9.87	156.9	9.51	151.7	9.16	141.4	8.47
	64.4	62.2	182.6	10.70	172.3	10.11	162.0	9.55	156.9	9.03	151.7	8.67	141.4	8.07
68.0	65.3	182.6	10.10	172.3	9.71	162.0	9.16	156.9	8.62	151.7	8.26	141.4	7.74	
75.2	68.9	182.6	9.55	172.3	9.38	162.0	8.80	156.9	8.30	151.7	7.94	141.4	7.50	
90%	-3.6	-4.0	102.9	12.21	102.3	12.63	102.3	13.07	101.8	13.28	101.8	13.51	101.8	13.93
	-1.8	-2.2	104.4	12.34	104.4	12.78	103.9	13.20	103.9	13.41	103.9	13.62	103.4	14.04
	1.9	1.4	108.5	12.65	108.0	13.05	108.0	13.46	108.0	13.67	107.5	13.86	107.5	14.27
	7.3	5.0	113.1	12.95	112.6	13.34	112.6	13.73	112.1	13.80	112.1	14.12	112.1	14.51
	10.8	8.6	117.8	13.26	117.8	13.64	117.3	14.01	117.3	14.20	117.3	14.38	116.7	14.76
	14.4	12.2	123.4	13.57	123.4	13.93	122.9	14.29	122.9	14.48	122.9	14.66	122.4	15.02
	14.9	14.0	126.5	13.73	126.0	14.09	126.0	14.43	125.5	14.61	125.5	14.79	125.5	15.13
	16.7	15.6	129.1	13.88	129.1	14.22	128.6	14.56	128.6	14.72	128.6	14.90	127.0	15.05
	19.4	18.3	133.7	14.11	133.7	14.43	133.2	14.77	133.2	14.94	133.2	15.10	127.0	14.37
	23.0	21.9	140.9	14.42	140.4	14.72	140.4	15.03	140.4	15.19	136.3	14.72	127.0	13.51
	26.6	25.3	147.6	14.69	147.6	13.36	146.1	15.05	140.9	14.45	136.3	13.86	127.0	12.73
	32.0	30.7	159.9	15.11	155.3	13.12	146.1	13.65	140.9	13.12	136.3	12.60	127.0	11.57
	37.4	36.0	164.6	14.40	155.3	13.41	146.1	12.44	140.9	11.96	136.3	11.49	127.0	10.58
	41.0	39.4	164.6	13.54	155.3	12.61	146.1	11.72	140.9	11.27	136.3	10.84	127.0	9.98
	44.6	42.8	164.6	12.73	155.3	11.88	146.1	11.04	140.9	10.63	136.3	10.23	127.0	9.43
	48.2	46.2	164.6	12.00	155.3	11.19	146.1	10.41	140.9	10.03	136.3	9.66	127.0	8.91
	51.8	49.6	164.6	11.30	155.3	10.55	146.1	9.84	140.9	9.48	136.3	9.12	127.0	8.44
	55.4	53.2	164.6	10.63	155.3	9.95	146.1	9.27	140.9	8.94	136.3	8.62	127.0	7.97
	59.0	56.7	164.6	10.05	155.3	9.40	146.1	8.78	140.9	8.44	136.3	8.17	127.0	7.56
	64.4	62.2	164.6	9.50	155.3	8.88	146.1	8.33	140.9	7.97	136.3	7.74	127.0	7.19
68.0	65.3	164.6	8.98	155.3	8.39	146.1	7.91	140.9	7.52	136.3	7.35	127.0	6.87	
75.2	68.9	164.6	8.47	155.3	7.92	146.1	7.50	140.9	7.09	136.3	6.98	127.0	6.56	

GMV5 DC Inverter VRF Units Technical Sales Guide

Combination	Outdoor air temp.		Indoor air temperature											
			61		64		68		70		72		75	
	°FDB	°FWB	TC	PI	TC	PI	TC	PI	TC	PI	TC	PI	TC	PI
			KBtu/h	kW	KBtu/h	kW	KBtu/h	kW	KBtu/h	kW	KBtu/h	kW	KBtu/h	kW
80%	-3.6	-4.0	102.3	13.05	101.8	13.43	101.8	13.81	101.8	14.01	101.3	14.20	101.3	14.58
	-1.8	-2.2	103.9	13.17	103.9	13.56	103.4	13.93	103.4	14.12	103.4	14.30	102.9	14.69
	1.9	1.4	108.0	13.44	107.5	13.80	107.5	14.17	107.5	14.35	107.5	14.53	107.0	14.89
	7.3	5.0	112.6	13.72	112.1	14.06	112.1	14.42	112.1	14.58	111.6	14.76	111.6	15.11
	10.8	8.6	117.3	13.99	117.3	14.33	116.7	14.66	116.7	14.82	116.7	15.00	113.1	14.59
	14.4	12.2	122.9	14.27	122.9	14.59	122.4	14.92	122.4	15.06	121.4	15.03	113.1	13.78
	14.9	14.0	126.0	14.42	125.5	14.72	125.5	15.03	125.5	15.19	121.4	14.59	113.1	13.38
	16.7	15.6	128.6	14.55	128.6	14.85	128.1	15.15	125.5	14.82	121.4	14.20	113.1	13.02
	19.4	18.3	133.2	14.76	133.2	15.05	129.6	14.72	125.5	14.14	121.4	13.57	113.1	12.50
	23.0	21.9	140.4	13.39	137.8	14.94	129.6	13.83	125.5	13.30	121.4	12.76	113.1	11.72
	26.6	25.3	146.1	13.47	137.8	14.06	129.6	13.02	125.5	12.58	121.4	12.03	113.1	11.07
	32.0	30.7	146.1	13.70	137.8	12.76	129.6	11.85	125.5	11.41	121.4	10.96	113.1	10.10
	37.4	36.0	146.1	12.48	137.8	11.64	129.6	10.83	125.5	10.42	121.4	10.03	113.1	9.25
	41.0	39.4	146.1	11.75	137.8	10.97	129.6	10.21	125.5	9.84	121.4	9.48	113.1	8.75
	44.6	42.8	146.1	11.07	137.8	10.37	129.6	9.64	125.5	9.30	121.4	8.96	113.1	8.28
	48.2	46.2	146.1	10.45	137.8	9.77	129.6	9.16	125.5	8.78	121.4	8.47	113.1	7.84
	51.8	49.6	146.1	9.87	137.8	9.24	129.6	8.62	125.5	8.31	121.4	8.02	113.1	7.44
	55.4	53.2	146.1	9.30	137.8	8.72	129.6	8.15	125.5	7.86	121.4	7.58	113.1	7.03
	59.0	56.7	146.1	8.80	137.8	8.26	129.6	7.73	125.5	7.45	121.4	7.19	113.1	6.69
	64.4	62.2	146.1	8.39	137.8	7.86	129.6	7.35	125.5	7.08	121.4	6.82	113.1	6.38
68.0	65.3	146.1	8.07	137.8	7.53	129.6	7.03	125.5	6.75	121.4	6.49	113.1	6.09	
75.2	68.9	146.1	7.82	137.8	7.29	129.6	6.74	125.5	6.46	121.4	6.20	113.1	5.83	
70%	-3.6	-4.0	101.8	13.90	101.3	14.22	101.3	14.56	101.3	14.72	101.3	14.90	98.7	14.74
	-1.8	-2.2	103.4	14.01	103.4	14.33	102.9	14.66	102.9	14.82	102.9	15.00	98.7	14.43
	1.9	1.4	107.5	14.24	107.5	14.56	107.0	14.87	107.0	15.03	105.9	15.02	98.7	13.77
	7.3	5.0	112.1	14.48	111.6	14.79	111.6	15.10	109.5	144.74	105.9	14.27	98.7	13.08
	10.8	8.6	116.7	14.72	116.7	15.02	113.7	14.66	109.5	14.09	105.9	13.52	98.7	12.40
	14.4	12.2	122.4	14.97	120.9	14.95	113.7	13.85	109.5	13.31	105.9	12.78	98.7	11.74
	14.9	14.0	125.5	15.10	120.9	14.51	113.7	13.44	109.5	12.92	105.9	12.42	98.7	11.41
	16.7	15.6	128.1	15.18	120.9	14.12	113.7	13.08	109.5	12.58	105.9	12.09	98.7	11.12
	19.4	18.3	128.1	14.50	120.9	13.49	113.7	12.52	109.5	12.05	105.9	11.57	98.7	10.65
	23.0	21.9	128.1	13.62	120.9	12.69	113.7	11.79	109.5	11.33	105.9	10.89	98.7	10.05
	26.6	25.3	128.1	12.82	120.9	11.96	113.7	11.12	109.5	10.70	105.9	10.29	98.7	9.50
	32.0	30.7	128.1	11.67	120.9	10.96	113.7	10.15	109.5	9.77	105.9	9.42	98.7	8.70
	37.4	36.0	128.1	10.67	120.9	0.24	113.7	9.30	109.5	8.96	105.9	8.64	98.7	7.99
	41.0	39.4	128.1	10.06	120.9	9.42	113.7	8.80	109.5	8.47	105.9	8.18	98.7	7.56
	44.6	42.8	128.1	9.51	120.9	8.91	113.7	8.31	109.5	8.02	105.9	7.74	98.7	7.18
	48.2	46.2	128.1	8.99	120.9	8.43	113.7	7.87	109.5	7.60	105.9	7.34	98.7	6.80
	51.8	49.6	128.1	8.51	120.9	7.97	113.7	7.47	109.5	7.21	105.9	6.96	98.7	6.46
	55.4	53.2	128.1	8.04	120.9	7.55	113.7	7.06	109.5	6.83	105.9	6.59	98.7	6.14
	59.0	56.7	128.1	7.61	120.9	7.16	113.7	6.70	109.5	6.49	105.9	6.27	98.7	5.84
	64.4	62.2	128.1	7.22	120.9	6.80	113.7	6.38	109.5	6.19	105.9	5.97	98.7	5.58
68.0	65.3	128.1	6.88	120.9	6.48	113.7	6.09	109.5	5.91	105.9	5.71	98.7	5.36	
75.2	68.9	128.1	6.57	120.9	6.19	113.7	5.84	109.5	5.67	105.9	5.50	98.7	5.16	

Combination	Outdoor air temp.		Indoor air temperature											
			61		64		68		70		72		75	
	°FDB	°FWB	TC	PI	TC	PI	TC	PI	TC	PI	TC	PI	TC	PI
			KBtu/h	kW	KBtu/h	kW	KBtu/h	kW	KBtu/h	kW	KBtu/h	kW	KBtu/h	kW
60%	-3.6	-4.0	101.3	14.74	100.8	15.02	97.2	14.45	94.1	13.88	91.0	13.33	84.9	12.22
	-1.8	-2.2	102.9	14.84	102.9	15.11	97.2	14.14	94.1	13.59	91.0	13.04	84.9	11.96
	1.9	1.4	107.0	15.03	103.4	14.56	97.2	13.49	94.1	12.97	91.0	12.45	84.9	11.44
	7.3	5.0	109.5	14.87	103.4	13.83	97.2	12.82	94.1	12.34	91.0	11.85	84.9	10.89
	10.8	8.6	109.5	14.07	103.4	13.10	97.2	12.16	94.1	11.70	91.0	11.25	84.9	10.36
	14.4	12.2	109.5	13.30	103.4	12.39	97.2	11.51	94.1	11.07	91.0	10.65	84.9	9.82
	14.9	14.0	109.5	12.92	103.4	12.05	97.2	11.19	94.1	10.78	91.0	10.36	84.9	9.55
	16.7	15.6	109.5	12.58	103.4	11.74	97.2	10.91	94.1	10.50	91.0	10.10	84.9	9.32
	19.4	18.3	109.5	12.03	103.4	11.23	97.2	10.44	94.1	10.06	91.0	9.68	84.9	8.94
	23.0	21.9	109.5	11.33	103.4	10.58	97.2	9.85	94.1	9.50	91.0	9.14	84.9	8.46
	26.6	25.3	109.5	10.70	103.4	10.00	97.2	9.35	94.1	8.99	91.0	8.65	84.9	8.00
	32.0	30.7	109.5	9.77	103.4	9.16	97.2	8.54	94.1	8.25	91.0	7.94	84.9	7.35
	37.4	36.0	109.5	8.96	103.4	8.41	97.2	7.86	94.1	7.58	91.0	7.32	84.9	0.29
	41.0	39.4	109.5	8.47	103.4	7.95	97.2	7.44	94.1	7.19	91.0	6.93	84.9	6.44
	44.6	42.8	109.5	8.02	103.4	7.53	97.2	7.05	94.1	6.82	91.0	6.59	84.9	6.12
	48.2	46.2	109.5	7.60	103.4	7.14	97.2	6.69	94.1	6.48	91.0	6.25	84.9	5.83
	51.8	49.6	109.5	7.21	103.4	6.79	97.2	6.36	94.1	6.15	91.0	5.94	84.9	5.55
	55.4	53.2	109.5	6.82	103.4	6.43	97.2	6.04	94.1	5.84	91.0	5.65	84.9	5.28
	59.0	56.7	109.5	6.49	103.4	6.10	97.2	5.75	94.1	5.57	91.0	5.39	84.9	5.03
	64.4	62.2	109.5	6.20	103.4	5.81	97.2	5.49	94.1	5.32	91.0	5.16	84.9	4.82
68.0	65.3	109.5	5.94	103.4	5.55	97.2	5.26	94.1	5.11	91.0	4.97	84.9	4.64	
75.2	68.9	109.5	5.71	103.4	5.32	97.2	5.06	94.1	4.94	91.0	4.81	84.9	4.48	
50%	-3.6	-4.0	91.5	13.41	86.4	12.48	81.3	11.59	78.2	11.17	75.6	10.73	70.5	9.89
	-1.8	-2.2	91.5	13.12	86.4	12.22	81.3	11.36	78.2	10.93	75.6	10.50	70.5	9.69
	1.9	1.4	91.5	12.52	86.4	11.67	81.3	10.86	78.2	10.45	75.6	10.06	70.5	9.29
	7.3	5.0	91.5	11.92	86.4	11.12	81.3	10.34	78.2	9.97	75.6	9.59	70.5	8.86
	10.8	8.6	91.5	11.31	86.4	10.58	81.3	9.84	78.2	9.48	75.6	9.12	70.5	8.44
	14.4	12.2	91.5	10.71	86.4	10.02	81.3	9.33	78.2	8.99	75.6	8.67	70.5	8.02
	14.9	14.0	91.5	10.42	86.4	9.74	81.3	9.09	78.2	8.77	75.6	8.44	70.5	7.81
	16.7	15.6	91.5	10.16	86.4	9.51	81.3	8.86	78.2	8.56	75.6	8.25	70.5	7.63
	19.4	18.3	91.5	9.74	86.4	9.16	81.3	8.51	78.2	8.21	75.6	7.92	70.5	7.34
	23.0	21.9	91.5	9.19	86.4	8.62	81.3	8.05	78.2	7.78	75.6	7.50	70.5	6.95
	26.6	25.3	91.5	8.70	86.4	8.17	81.3	7.63	78.2	7.37	75.6	7.11	70.5	6.61
	32.0	30.7	91.5	7.99	86.4	7.50	81.3	7.03	78.2	6.79	75.6	6.56	70.5	6.10
	37.4	36.0	91.5	7.35	86.4	6.92	81.3	6.48	78.2	6.27	75.6	6.07	70.5	5.65
	41.0	39.4	91.5	6.98	86.4	6.56	81.3	6.15	78.2	5.96	75.6	5.76	70.5	5.37
	44.6	42.8	91.5	6.62	86.4	6.23	81.3	5.86	78.2	5.67	75.6	5.49	70.5	5.13
	48.2	46.2	91.5	6.28	86.4	5.93	81.3	5.57	78.2	5.41	75.6	5.23	70.5	4.89
	51.8	49.6	91.5	5.97	86.4	5.63	81.3	5.31	78.2	5.15	75.6	4.98	70.5	4.66
	55.4	53.2	91.5	5.68	86.4	5.36	81.3	5.05	78.2	4.90	75.6	4.74	70.5	4.45
	59.0	56.7	91.5	5.41	86.4	5.11	81.3	4.82	78.2	4.68	75.6	4.53	70.5	4.24
	64.4	62.2	91.5	5.15	86.4	4.89	81.3	4.63	78.2	4.48	75.6	4.33	70.5	4.04
68.0	65.3	91.5	4.90	86.4	4.68	81.3	4.45	78.2	4.32	75.6	4.16	70.5	3.86	
75.2	68.9	91.5	4.68	86.4	4.48	81.3	4.14	78.2	4.17	75.6	3.99	70.5	3.70	

GMV5 DC Inverter VRF Units Technical Sales Guide

GMV-168WM/B1-F(U)

TC—Total capacity of outdoor unit; PI—Power input of outdoor unit

Combination	Outdoor air temp.		Indoor air temperature											
			61		64		68		70		72		75	
	°FDB	°FWB	TC	PI	TC	PI	TC	PI	TC	PI	TC	PI	TC	PI
			KBtu/h	kW	KBtu/h	kW	KBtu/h	kW	KBtu/h	kW	KBtu/h	kW	KBtu/h	kW
135%	-3.6	-4.0	122.4	10.07	121.8	10.77	121.2	11.49	121.2	11.84	120.6	12.20	120.6	12.92
	-1.8	-2.2	124.2	10.29	123.6	10.99	123.6	11.70	123.0	12.05	123.0	12.38	122.4	13.08
	1.9	1.4	129.0	10.77	128.4	11.44	127.8	12.12	127.8	12.40	127.8	12.79	127.2	13.47
	7.3	5.0	134.4	11.27	133.8	11.92	133.2	12.57	133.2	12.88	132.6	13.21	132.6	13.86
	10.8	8.6	139.8	11.77	139.8	12.40	139.2	13.01	138.6	13.32	138.6	13.64	138.0	14.25
	14.4	12.2	146.4	12.29	145.8	12.88	145.2	13.47	145.2	13.77	145.2	14.06	144.6	14.66
	14.9	14.0	150.0	12.55	149.4	13.12	148.8	13.69	148.8	13.99	148.2	14.27	148.2	14.84
	16.7	15.6	153.0	12.77	152.4	13.32	152.4	13.90	151.8	14.18	151.8	14.45	151.2	15.03
	19.4	18.3	158.4	13.14	158.4	13.69	157.8	14.23	157.8	14.51	157.2	14.77	156.6	15.32
	23.0	21.9	166.8	13.64	166.2	13.88	165.6	14.68	165.6	14.93	165.0	15.18	165.0	15.69
	26.6	25.3	174.6	14.08	174.0	14.58	174.0	15.06	173.4	15.32	173.4	15.56	172.8	16.05
	32.0	30.7	188.4	14.77	188.4	15.23	187.8	15.68	187.8	15.90	187.2	16.14	187.2	16.58
	37.4	36.0	203.4	15.38	202.8	15.80	202.2	16.23	202.2	16.43	202.2	16.66	201.6	17.06
	41.0	39.4	213.6	15.77	213.0	16.17	213.0	16.56	212.4	16.77	212.4	16.97	211.8	17.36
	44.6	42.8	224.4	16.14	223.8	16.51	223.8	16.90	223.2	17.23	223.2	17.27	214.2	16.58
	48.2	46.2	235.8	16.47	235.2	16.84	235.2	17.19	234.6	17.38	229.8	17.02	214.2	15.58
	51.8	49.6	247.8	16.80	247.2	17.14	246.0	17.36	237.6	16.67	229.8	15.99	214.2	14.68
	55.4	53.2	261.0	17.12	260.4	17.45	246.0	16.27	237.6	15.62	229.8	15.01	214.2	13.77
	59.0	56.7	273.6	17.41	261.6	16.53	246.0	15.32	237.6	14.73	229.8	14.14	214.2	12.99
64.4	62.2	273.6	16.49	261.6	15.73	246.0	14.53	237.6	13.99	229.8	13.36	214.2	12.34	
68.0	65.3	273.6	15.69	261.6	15.03	246.0	13.86	237.6	13.36	229.8	12.70	214.2	11.79	
75.2	68.9	273.6	15.01	261.6	14.45	246.0	13.32	237.6	12.84	229.8	12.12	214.2	11.36	
120%	-3.6	-4.0	121.8	11.03	121.2	11.68	120.6	12.34	120.6	12.66	120.6	12.99	120.0	13.66
	-1.8	-2.2	123.6	11.23	123.0	11.88	123.0	12.40	122.4	12.84	122.4	13.18	121.8	13.82
	1.9	1.4	128.4	11.68	127.8	12.31	127.8	12.92	127.2	13.23	127.2	13.55	126.6	14.16
	7.3	5.0	133.8	12.14	133.2	12.73	132.6	13.32	132.6	13.64	132.6	13.94	132.0	14.53
	10.8	8.6	139.2	12.60	139.2	13.18	138.6	13.75	138.6	14.05	138.0	14.32	138.0	14.90
	14.4	12.2	145.8	13.08	145.2	13.62	145.2	14.18	144.6	14.45	144.6	14.71	144.0	15.29
	14.9	14.0	149.4	13.32	148.8	13.86	148.2	14.38	148.2	14.66	148.2	14.81	147.6	15.45
	16.7	15.6	152.4	13.53	151.8	14.05	151.8	14.56	151.2	14.82	151.2	15.10	150.6	15.62
	19.4	18.3	157.8	13.88	157.8	14.38	157.2	14.88	157.2	15.14	156.6	15.38	156.6	15.88
	23.0	21.9	166.2	14.32	165.6	14.81	165.0	15.29	165.0	15.53	165.0	15.77	164.4	16.23
	26.6	25.3	174.0	14.75	174.0	15.21	173.4	15.66	173.4	15.88	172.8	16.12	172.8	16.56
	32.0	30.7	187.8	15.38	187.8	15.80	187.2	16.42	187.2	16.43	186.6	16.64	186.6	17.06
	37.4	36.0	202.8	15.95	202.2	16.34	202.2	16.73	201.6	16.93	201.6	17.12	197.4	17.03
	41.0	39.4	213.0	16.30	212.4	16.67	212.4	17.04	211.8	17.23	211.8	17.41	197.4	15.99
	44.6	42.8	223.8	16.64	223.8	16.99	223.2	17.34	219.6	17.10	212.4	16.40	197.4	15.05
	48.2	46.2	235.2	16.97	234.6	17.30	226.8	16.73	219.6	16.06	212.4	15.42	197.4	14.16
	51.8	49.6	247.2	17.27	241.2	16.97	226.8	15.73	219.6	15.12	212.4	14.51	197.4	13.34
	55.4	53.2	256.2	17.10	241.2	15.92	226.8	14.75	219.6	14.19	212.4	13.64	197.4	12.55
	59.0	56.7	256.2	16.10	241.2	14.99	226.8	13.92	219.6	13.38	212.4	12.86	197.4	11.84
64.4	62.2	256.2	15.21	241.2	14.19	226.8	13.21	219.6	12.68	212.4	12.18	197.4	11.23	
68.0	65.3	256.2	14.42	241.2	13.55	226.8	12.64	219.6	12.08	212.4	11.60	197.4	10.70	
75.2	68.9	256.2	13.71	241.2	12.99	226.8	12.18	219.6	11.59	212.4	11.14	197.4	10.25	

Combination	Outdoor air temp.		Indoor air temperature											
			61		64		68		70		72		75	
	°FDB	°FWB	TC	PI	TC	PI	TC	PI	TC	PI	TC	PI	TC	PI
			KBtu/h	kW	KBtu/h	kW	KBtu/h	kW	KBtu/h	kW	KBtu/h	kW	KBtu/h	kW
110%	-3.6	-4.0	121.2	11.99	120.6	12.58	120.0	13.20	120.0	13.49	120.0	13.79	119.4	14.40
	-1.8	-2.2	123.0	12.18	123.0	12.77	122.4	13.36	122.4	13.66	121.8	13.95	121.8	14.55
	1.9	1.4	127.8	12.58	127.2	13.16	127.2	13.73	126.6	14.01	126.6	14.31	126.0	14.86
	7.3	5.0	133.2	13.01	132.6	13.57	132.0	14.10	132.0	14.38	132.0	14.66	131.4	15.19
	10.8	8.6	138.6	13.45	138.6	13.97	138.0	14.49	138.0	14.75	137.4	15.01	137.4	15.55
	14.4	12.2	145.2	13.88	144.6	14.38	144.6	14.88	144.0	15.14	144.0	15.38	144.0	15.88
	14.9	14.0	148.8	14.10	148.2	14.58	147.6	15.08	147.6	15.32	147.6	15.56	147.0	16.05
	16.7	15.6	151.8	14.29	151.2	14.77	151.2	15.25	151.2	15.49	150.6	15.73	150.6	16.19
	19.4	18.3	157.2	14.62	157.2	15.06	156.6	15.53	156.6	15.77	158.4	15.99	156.0	16.45
	23.0	21.9	165.6	15.03	165.0	15.47	164.4	15.90	164.4	16.12	172.2	16.34	163.8	16.79
	26.6	25.3	173.4	15.42	173.4	15.82	172.8	16.25	172.8	16.45	186.6	16.66	172.2	17.08
	32.0	30.7	187.2	15.99	187.2	16.38	186.6	16.77	186.6	16.95	194.4	17.16	181.2	16.82
	37.4	36.0	202.2	16.53	201.6	16.88	201.6	17.23	201.0	17.40	194.4	16.69	181.2	15.30
	41.0	39.4	212.4	16.84	212.4	17.19	208.2	17.03	201.0	16.34	194.4	15.69	181.2	14.40
	44.6	42.8	223.2	17.16	221.4	17.27	208.2	15.99	201.0	15.36	194.4	14.75	181.2	13.55
	48.2	46.2	234.6	17.43	221.4	16.23	208.2	15.05	201.0	14.45	194.4	13.88	181.2	12.77
	51.8	49.6	234.6	16.40	221.4	15.27	208.2	14.16	201.0	13.62	194.4	13.08	181.2	12.05
	55.4	53.2	234.6	15.38	221.4	14.32	208.2	13.31	201.0	12.81	194.4	12.31	181.2	11.34
59.0	56.7	234.6	14.49	221.4	13.51	208.2	12.57	201.0	12.08	194.4	11.64	181.2	10.73	
64.4	62.2	234.6	13.71	221.4	12.81	208.2	11.46	201.0	11.46	194.4	11.09	181.2	10.22	
68.0	65.3	234.6	13.01	221.4	12.18	208.2	10.86	201.0	10.90	194.4	10.62	181.2	9.77	
75.2	68.9	234.6	12.42	221.4	11.62	208.2	10.35	201.0	10.44	194.4	10.23	181.2	9.40	
100%	-3.6	-4.0	120.6	12.95	120.0	13.49	120.0	14.05	119.4	14.32	119.4	14.58	118.8	15.14
	-1.8	-2.2	122.4	13.12	122.4	13.66	121.8	14.19	121.8	14.47	121.2	14.75	121.2	15.29
	1.9	1.4	127.2	13.49	126.6	14.01	126.6	14.53	126.6	14.79	126.0	15.05	126.0	15.56
	7.3	5.0	132.6	13.88	132.0	14.38	132.0	14.88	131.4	15.14	131.4	15.38	130.8	15.88
	10.8	8.6	138.0	14.29	138.0	14.75	137.4	15.23	137.4	15.47	137.4	15.16	136.8	16.19
	14.4	12.2	144.6	14.68	144.0	15.14	144.0	15.58	144.0	15.82	143.4	16.05	143.4	16.49
	14.9	14.0	148.2	14.88	147.6	15.32	147.6	15.77	147.0	15.99	147.0	16.21	146.4	16.66
	16.7	15.6	151.2	15.05	151.2	15.49	150.6	15.92	150.6	16.14	150.0	16.36	150.0	16.79
	19.4	18.3	156.6	15.34	156.6	15.77	156.0	16.17	156.0	16.40	156.0	16.60	155.4	17.03
	23.0	21.9	165.0	15.73	164.4	16.12	164.4	16.53	163.8	16.73	163.8	16.91	163.8	17.32
	26.6	25.3	172.8	16.08	172.8	16.45	172.2	16.84	172.2	17.03	172.2	17.21	165.0	16.49
	32.0	30.7	186.6	16.62	186.6	16.95	186.0	17.30	183.0	17.03	177.0	16.32	165.0	14.99
	37.4	36.0	201.6	17.08	201.0	17.40	189.0	16.10	183.0	15.47	177.0	14.86	165.0	13.64
	41.0	39.4	211.8	17.40	201.0	16.34	189.0	15.14	183.0	14.56	177.0	13.99	165.0	12.86
	44.6	42.8	213.0	16.51	201.0	15.36	189.0	14.25	183.0	13.71	177.0	13.18	165.0	12.12
	48.2	46.2	213.0	15.51	201.0	14.45	189.0	13.42	183.0	12.92	177.0	12.42	165.0	11.44
	51.8	49.6	213.0	14.60	201.0	13.62	189.0	12.66	183.0	12.18	177.0	11.71	165.0	10.81
	55.4	53.2	213.0	13.71	201.0	12.81	189.0	11.92	183.0	11.47	177.0	11.05	165.0	10.20
59.0	56.7	213.0	12.94	201.0	12.08	189.0	11.25	183.0	10.84	177.0	10.44	165.0	9.66	
64.4	62.2	213.0	12.20	201.0	11.53	189.0	10.88	183.0	10.29	177.0	9.88	165.0	9.20	
68.0	65.3	213.0	11.51	201.0	11.07	189.0	10.44	183.0	9.83	177.0	9.42	165.0	8.83	
75.2	68.9	213.0	10.88	201.0	10.70	189.0	10.03	183.0	9.46	177.0	9.05	165.0	8.55	

GMV5 DC Inverter VRF Units Technical Sales Guide

Combination	Outdoor air temp.		Indoor air temperature											
			61		64		68		70		72		75	
	°FDB	°FWB	TC	PI	TC	PI	TC	PI	TC	PI	TC	PI	TC	PI
			KBtu/h	kW	KBtu/h	kW	KBtu/h	kW	KBtu/h	kW	KBtu/h	kW	KBtu/h	kW
90%	-3.6	-4.0	120.0	13.92	119.4	14.40	119.4	14.90	118.8	15.14	118.8	15.40	118.8	15.88
	-1.8	-2.2	121.8	14.06	121.8	14.56	121.2	15.05	121.2	15.29	121.2	15.53	120.6	16.01
	1.9	1.4	126.6	14.42	126.0	14.88	126.0	15.34	126.0	15.58	125.4	15.80	125.4	16.27
	7.3	5.0	132.0	14.77	131.4	15.21	131.4	15.66	130.8	15.73	130.8	16.10	130.8	16.54
	10.8	8.6	137.4	15.12	137.4	15.55	136.8	15.97	136.8	16.19	136.8	16.40	136.2	16.82
	14.4	12.2	144.0	15.47	144.0	15.88	143.4	16.29	143.4	16.51	143.4	16.71	142.8	17.12
	14.9	14.0	147.6	15.66	147.0	16.06	147.0	16.45	146.4	16.66	146.4	16.86	146.4	17.25
	16.7	15.6	150.6	15.82	150.6	16.21	150.0	16.60	150.0	16.79	150.0	16.99	148.2	17.16
	19.4	18.3	156.0	16.08	156.0	16.45	155.4	16.84	155.4	17.03	155.4	17.21	148.2	16.38
	23.0	21.9	164.4	16.43	163.8	16.79	163.8	17.14	163.8	17.32	159.0	16.79	148.2	15.40
	26.6	25.3	172.2	16.75	172.2	15.23	170.4	17.16	164.4	16.47	159.0	15.80	148.2	14.51
	32.0	30.7	186.6	17.23	181.2	14.95	170.4	15.56	164.4	14.95	159.0	14.36	148.2	13.20
	37.4	36.0	192.0	16.42	181.2	15.29	170.4	14.18	164.4	13.64	159.0	13.10	148.2	12.07
	41.0	39.4	192.0	15.43	181.2	14.38	170.4	13.36	164.4	12.84	159.0	12.36	148.2	11.38
	44.6	42.8	192.0	14.51	181.2	13.55	170.4	12.58	164.4	12.12	159.0	11.66	148.2	10.75
	48.2	46.2	192.0	13.68	181.2	12.75	170.4	11.86	164.4	11.44	159.0	11.01	148.2	10.16
	51.8	49.6	192.0	12.88	181.2	12.03	170.4	11.21	164.4	10.81	159.0	10.40	148.2	9.62
	55.4	53.2	192.0	12.12	181.2	11.34	170.4	10.57	164.4	10.20	159.0	9.83	148.2	9.09
59.0	56.7	192.0	11.46	181.2	10.72	170.4	10.01	164.4	9.62	159.0	9.31	148.2	8.62	
64.4	62.2	192.0	10.83	181.2	10.12	170.4	9.49	164.4	9.09	159.0	8.83	148.2	8.20	
68.0	65.3	192.0	10.23	181.2	9.57	170.4	9.01	164.4	8.57	159.0	8.38	148.2	7.83	
75.2	68.9	192.0	9.66	181.2	9.03	170.4	8.55	164.4	8.09	159.0	7.96	148.2	7.48	
80%	-3.6	-4.0	119.4	14.88	118.8	15.30	118.8	15.75	118.8	15.97	118.2	16.19	118.2	16.62
	-1.8	-2.2	121.2	15.01	121.2	15.45	120.6	15.88	120.6	16.10	120.6	16.30	120.0	16.75
	1.9	1.4	126.0	15.32	125.4	15.73	125.4	16.16	125.4	16.36	125.4	16.56	124.8	16.97
	7.3	5.0	131.4	15.64	130.8	16.03	130.8	16.43	130.8	16.62	130.2	16.82	130.2	17.23
	10.8	8.6	136.8	15.95	136.8	16.34	136.2	16.71	136.2	16.90	136.2	17.10	132.0	16.64
	14.4	12.2	143.4	16.27	143.4	16.64	142.8	17.01	142.8	17.17	141.6	17.14	132.0	15.71
	14.9	14.0	147.0	16.43	146.4	16.79	146.4	17.14	146.4	17.32	141.6	16.64	132.0	15.25
	16.7	15.6	150.0	16.58	150.0	16.93	149.4	17.27	146.4	16.90	141.6	16.19	132.0	14.84
	19.4	18.3	155.4	16.82	155.4	17.16	151.2	16.79	146.4	16.12	141.6	15.47	132.0	14.25
	23.0	21.9	163.8	15.27	160.8	17.03	151.2	15.77	146.4	15.16	141.6	14.55	132.0	13.36
	26.6	25.3	170.4	15.36	160.8	16.03	151.2	14.84	146.4	14.34	141.6	13.71	132.0	12.62
	32.0	30.7	170.4	15.62	160.8	14.55	151.2	13.51	146.4	13.01	141.6	12.49	132.0	11.51
	37.4	36.0	170.4	14.23	160.8	13.27	151.2	12.34	146.4	11.88	141.6	11.44	132.0	10.55
	41.0	39.4	170.4	13.40	160.8	12.51	151.2	11.64	146.4	11.21	141.6	10.81	132.0	9.98
	44.6	42.8	170.4	12.62	160.8	11.83	151.2	10.99	146.4	10.60	141.6	10.22	132.0	9.44
	48.2	46.2	170.4	11.92	160.8	11.14	151.2	10.44	146.4	10.01	141.6	9.66	132.0	8.94
	51.8	49.6	170.4	11.25	160.8	10.53	151.2	9.83	146.4	9.48	141.6	9.14	132.0	8.48
	55.4	53.2	170.4	10.60	160.8	9.94	151.2	9.29	146.4	8.96	141.6	8.64	132.0	8.01
59.0	56.7	170.4	10.03	160.8	9.42	151.2	8.81	146.4	8.49	141.6	8.20	132.0	7.62	
64.4	62.2	170.4	9.57	160.8	8.96	151.2	8.38	146.4	8.07	141.6	7.77	132.0	7.27	
68.0	65.3	170.4	9.20	160.8	8.59	151.2	8.01	146.4	7.70	141.6	7.40	132.0	6.94	
75.2	68.9	170.4	8.92	160.8	8.31	151.2	7.68	146.4	7.37	141.6	7.07	132.0	6.64	

Combination	Outdoor air temp.		Indoor air temperature											
			61		64		68		70		72		75	
	°FDB	°FWB	TC	PI	TC	PI	TC	PI	TC	PI	TC	PI	TC	PI
			KBtu/h	kW	KBtu/h	kW	KBtu/h	kW	KBtu/h	kW	KBtu/h	kW	KBtu/h	kW
70%	-3.6	-4.0	118.8	15.84	118.2	16.21	118.2	16.60	118.2	16.79	118.2	16.99	115.2	16.80
	-1.8	-2.2	120.6	15.97	120.6	16.34	120.0	16.71	120.0	16.90	120.0	17.10	115.2	16.45
	1.9	1.4	125.4	16.23	125.4	16.60	124.8	16.95	124.8	17.14	123.6	17.12	115.2	15.69
	7.3	5.0	130.8	16.51	130.2	16.86	130.2	17.21	127.8	165.00	123.6	16.27	115.2	14.92
	10.8	8.6	136.2	16.79	136.2	17.12	132.6	16.71	127.8	16.06	123.6	15.42	115.2	14.14
	14.4	12.2	142.8	17.06	141.0	17.04	132.6	15.79	127.8	15.18	123.6	14.56	115.2	13.38
	14.9	14.0	146.4	17.21	141.0	16.54	132.6	15.32	127.8	14.73	123.6	14.16	115.2	13.01
	16.7	15.6	149.4	17.30	141.0	16.10	132.6	14.92	127.8	14.34	123.6	13.79	115.2	12.68
	19.4	18.3	149.4	16.53	141.0	15.38	132.6	14.27	127.8	13.73	123.6	13.20	115.2	12.14
	23.0	21.9	149.4	15.53	141.0	14.47	132.6	13.44	127.8	12.92	123.6	12.42	115.2	11.46
	26.6	25.3	149.4	14.62	141.0	13.64	132.6	12.68	127.8	12.20	123.6	11.73	115.2	10.83
	32.0	30.7	149.4	13.31	141.0	12.49	132.6	11.57	127.8	11.14	123.6	10.73	115.2	9.92
	37.4	36.0	149.4	12.16	141.0	0.28	132.6	10.60	127.8	10.22	123.6	9.85	115.2	9.11
	41.0	39.4	149.4	11.47	141.0	10.73	132.6	10.03	127.8	9.66	123.6	9.33	115.2	8.62
	44.6	42.8	149.4	10.84	141.0	10.16	132.6	9.48	127.8	9.14	123.6	8.83	115.2	8.18
	48.2	46.2	149.4	10.25	141.0	9.60	132.6	8.98	127.8	8.66	123.6	8.36	115.2	7.75
	51.8	49.6	149.4	9.70	141.0	9.09	132.6	8.51	127.8	8.22	123.6	7.94	115.2	7.37
	55.4	53.2	149.4	9.16	141.0	8.61	132.6	8.05	127.8	7.79	123.6	7.51	115.2	7.00
59.0	56.7	149.4	8.68	141.0	8.16	132.6	7.64	127.8	7.40	123.6	7.14	115.2	6.66	
64.4	62.2	149.4	8.24	141.0	7.75	132.6	7.27	127.8	7.05	123.6	6.81	115.2	6.37	
68.0	65.3	149.4	7.85	141.0	7.38	132.6	6.94	127.8	6.74	123.6	6.51	115.2	6.11	
75.2	68.9	149.4	7.50	141.0	7.05	132.6	6.66	127.8	6.46	123.6	6.27	115.2	5.89	
60%	-3.6	-4.0	118.2	16.80	117.6	17.12	113.4	16.47	109.8	15.82	106.2	15.19	99.0	13.94
	-1.8	-2.2	120.0	16.91	120.0	17.23	113.4	16.12	109.8	15.49	106.2	14.86	99.0	13.64
	1.9	1.4	124.8	17.14	120.6	16.60	113.4	15.38	109.8	14.79	106.2	14.19	99.0	13.05
	7.3	5.0	127.8	16.95	120.6	15.77	113.4	14.62	109.8	14.06	106.2	13.51	99.0	12.42
	10.8	8.6	127.8	16.05	120.6	14.93	113.4	13.86	109.8	13.34	106.2	12.83	99.0	11.81
	14.4	12.2	127.8	15.16	120.6	14.12	113.4	13.12	109.8	12.62	106.2	12.14	99.0	11.20
	14.9	14.0	127.8	14.73	120.6	13.73	113.4	12.75	109.8	12.29	106.2	11.81	99.0	10.88
	16.7	15.6	127.8	14.34	120.6	13.38	113.4	12.44	109.8	11.97	106.2	11.51	99.0	10.62
	19.4	18.3	127.8	13.71	120.6	12.81	113.4	11.90	109.8	11.47	106.2	11.03	99.0	10.20
	23.0	21.9	127.8	12.92	120.6	12.07	113.4	11.23	109.8	10.83	106.2	10.42	99.0	9.64
	26.6	25.3	127.8	12.20	120.6	11.40	113.4	10.66	109.8	10.25	106.2	9.86	99.0	9.12
	32.0	30.7	127.8	11.14	120.6	10.44	113.4	9.73	109.8	9.40	106.2	9.05	99.0	8.38
	37.4	36.0	127.8	10.22	120.6	9.59	113.4	8.96	109.8	8.64	106.2	8.35	99.0	0.33
	41.0	39.4	127.8	9.66	120.6	9.07	113.4	8.48	109.8	8.20	106.2	7.90	99.0	7.35
	44.6	42.8	127.8	9.14	120.6	8.59	113.4	8.03	109.8	7.77	106.2	7.51	99.0	6.98
	48.2	46.2	127.8	8.66	120.6	8.14	113.4	7.62	109.8	7.38	106.2	7.13	99.0	6.64
	51.8	49.6	127.8	8.22	120.6	7.74	113.4	7.25	109.8	7.01	106.2	6.77	99.0	6.33
	55.4	53.2	127.8	7.77	120.6	7.33	113.4	6.88	109.8	6.66	106.2	6.44	99.0	6.01
59.0	56.7	127.8	7.40	120.6	6.96	113.4	6.55	109.8	6.35	106.2	6.14	99.0	5.74	
64.4	62.2	127.8	7.07	120.6	6.63	113.4	6.26	109.8	6.07	106.2	5.89	99.0	5.50	
68.0	65.3	127.8	6.77	120.6	6.33	113.4	6.00	109.8	5.83	106.2	5.66	99.0	5.29	
75.2	68.9	127.8	6.51	120.6	6.07	113.4	5.77	109.8	5.63	106.2	5.48	99.0	5.11	

Combination	Outdoor air temp.		Indoor air temperature											
			61		64		68		70		72		75	
	°FDB	°FWB	TC	PI	TC	PI	TC	PI	TC	PI	TC	PI	TC	PI
			KBtu/h	kW	KBtu/h	kW	KBtu/h	kW	KBtu/h	kW	KBtu/h	kW	KBtu/h	kW
50%	-3.6	-4.0	106.8	15.29	100.8	14.23	94.8	13.21	91.2	12.73	88.2	12.23	82.2	11.27
	-1.8	-2.2	106.8	14.95	100.8	13.94	94.8	12.95	91.2	12.45	88.2	11.97	82.2	11.05
	1.9	1.4	106.8	14.27	100.8	13.31	94.8	12.38	91.2	11.92	88.2	11.47	82.2	10.59
	7.3	5.0	106.8	13.58	100.8	12.68	94.8	11.79	91.2	11.36	88.2	10.94	82.2	10.10
	10.8	8.6	106.8	12.90	100.8	12.07	94.8	11.21	91.2	10.81	88.2	10.40	82.2	9.62
	14.4	12.2	106.8	12.21	100.8	11.42	94.8	10.64	91.2	10.25	88.2	9.88	82.2	9.14
	14.9	14.0	106.8	11.88	100.8	11.10	94.8	10.36	91.2	9.99	88.2	9.62	82.2	8.90
	16.7	15.6	106.8	11.59	100.8	10.84	94.8	10.10	91.2	9.75	88.2	9.40	82.2	8.70
	19.4	18.3	106.8	11.10	100.8	10.44	94.8	9.70	91.2	9.36	88.2	9.03	82.2	8.36
	23.0	21.9	106.8	10.47	100.8	9.83	94.8	9.18	91.2	8.86	88.2	8.55	82.2	7.92
	26.6	25.3	106.8	9.92	100.8	9.31	94.8	8.70	91.2	8.40	88.2	8.11	82.2	7.53
	32.0	30.7	106.8	9.11	100.8	8.55	94.8	8.01	91.2	7.74	88.2	7.48	82.2	6.96
	37.4	36.0	106.8	8.38	100.8	7.88	94.8	7.38	91.2	7.14	88.2	6.92	82.2	6.44
	41.0	39.4	106.8	7.96	100.8	7.48	94.8	7.01	91.2	6.79	88.2	6.57	82.2	6.13
	44.6	42.8	106.8	7.55	100.8	7.11	94.8	6.68	91.2	6.46	88.2	6.26	82.2	5.85
	48.2	46.2	106.8	7.16	100.8	6.75	94.8	6.35	91.2	6.16	88.2	5.96	82.2	5.57
	51.8	49.6	106.8	6.81	100.8	6.42	94.8	6.05	91.2	5.87	88.2	5.68	82.2	5.31
	55.4	53.2	106.8	6.48	100.8	6.11	94.8	5.76	91.2	5.59	88.2	5.40	82.2	5.07
59.0	56.7	106.8	6.16	100.8	5.83	94.8	5.50	91.2	5.33	88.2	5.16	82.2	4.83	
64.4	62.2	106.8	5.87	100.8	5.57	94.8	5.27	91.2	5.11	88.2	4.94	82.2	4.61	
68.0	65.3	106.8	5.59	100.8	5.33	94.8	5.07	91.2	4.92	88.2	4.74	82.2	4.40	
75.2	68.9	106.8	5.33	100.8	5.11	94.8	4.72	91.2	4.76	88.2	4.55	82.2	4.22	

6.2 Correction of Capacity Along with Piping Length and Height Drop

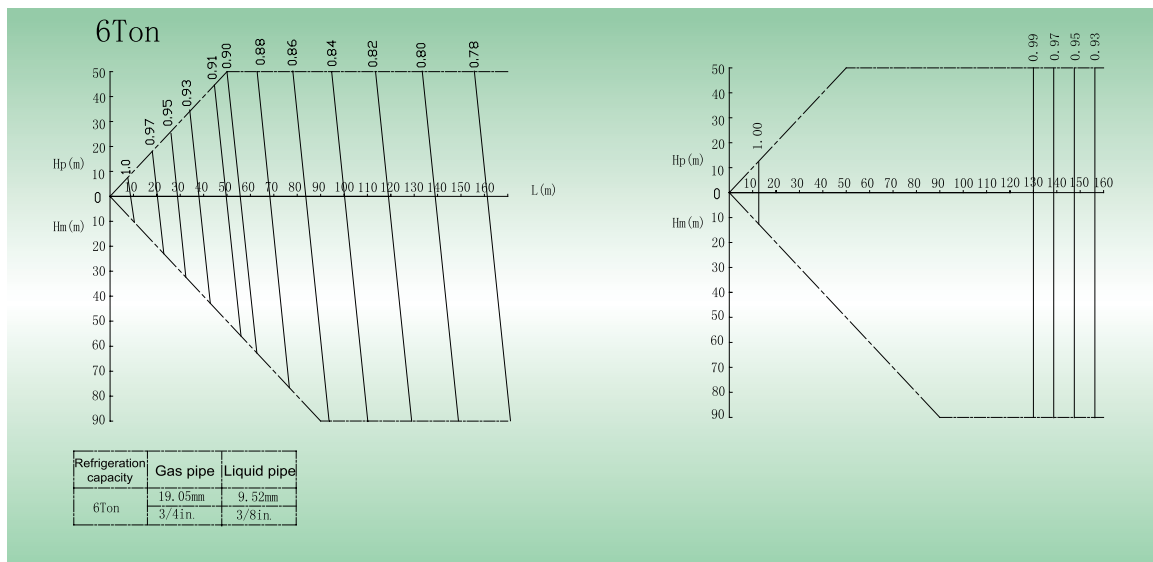

8Ton

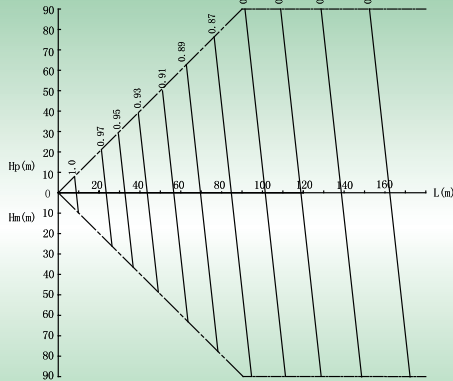

Refrigeration capacity	Gas pipe	Liquid pipe
8Ton	22.2mm 7/8in.	9.52mm 3/8in.

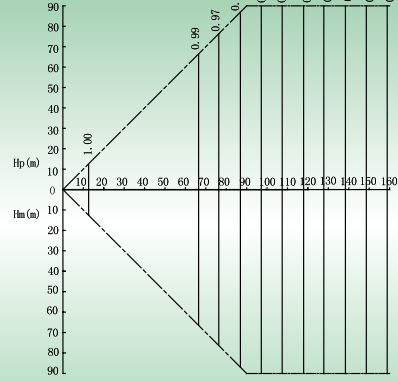

10Ton、20Ton、30Ton

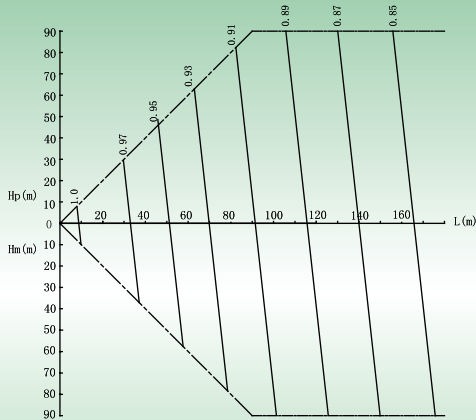

Refrigeration capacity	Gas pipe	Liquid pipe
10Ton	28.6mm 1-1/8in.	12.7mm 1/2in.
20Ton	34.9mm 1-3/8in.	15.9mm 5/8in.
30Ton	41.3mm 1-5/8in.	19.05mm 3/4in.

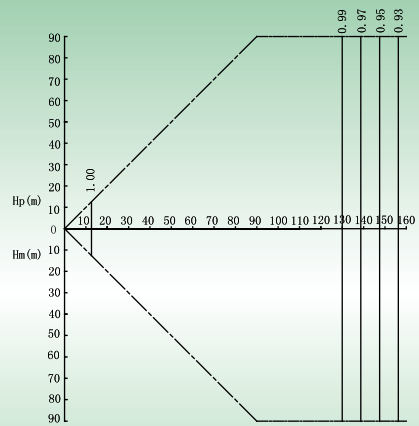

12Ton

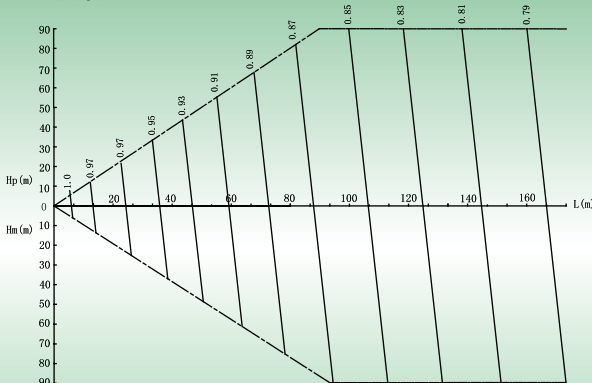

Refrigeration capacity	Gas pipe	Liquid pipe
12Ton	28.6mm 1-1/8in.	12.7mm 1/2in.

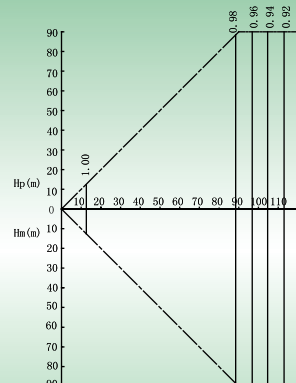

GMV5 DC Inverter VRF Units Technical Sales Guide

14Ton, 22Ton, 24Ton

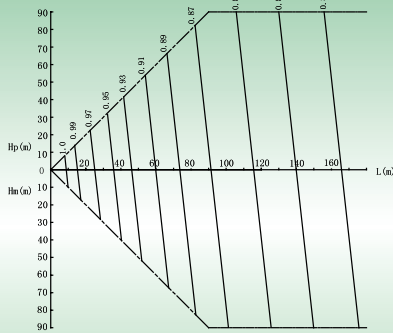

Refrigeration capacity	Gas pipe	Liquid pipe
14Ton	28.6mm	15.9mm
	1-1/8in.	5/8in.
22Ton	34.9mm	19.05mm
	1-3/8in.	3/4in.
24Ton	34.9mm	19.05mm
	1-3/8in.	3/4in.

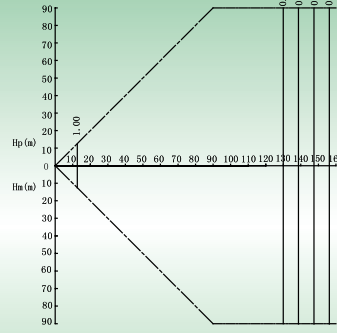

16Ton, 26Ton, 28Ton

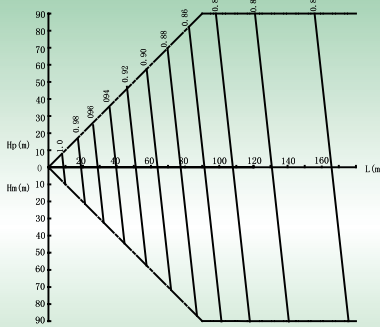

Refrigeration capacity	Gas pipe	Liquid pipe
16Ton	28.6mm	15.9mm
	1-1/8in.	5/8in.
26Ton	34.9mm	19.05mm
	1-3/8in.	3/4in.
28Ton	34.9mm	19.05mm
	1-3/8in.	3/4in.

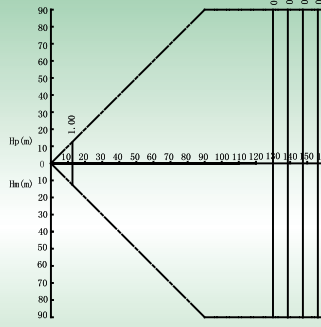

18Ton

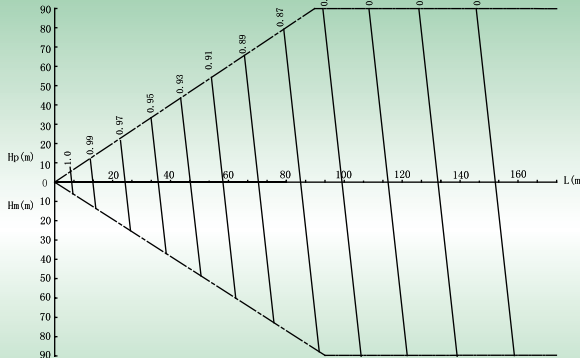

Refrigeration capacity	Gas pipe	Liquid pipe
18Ton	28.6mm	15.9mm
	1-1/8in.	5/8in.

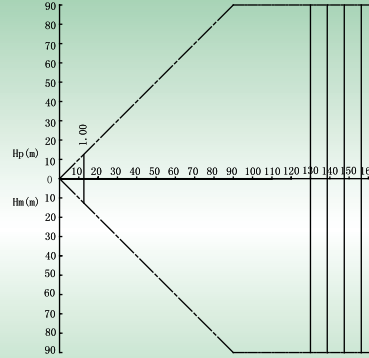

Notes for correction of the long connection pipe:

- a. The above connection of long connection pipe indicates the maximum capacity under the standard indoor unit capacity configuration.
- b. Set out below are some load configurations:
 Maximum system capacity: the smaller one of the indoor unit capacity and the maximum outdoor unit capacity (two algorithms are provided below)
 - ◆ When the configuration ratio of indoor unit is less than 100%
 Maximum outdoor unit capacity = Capacity when the configuration ratio is 100% in the outdoor unit capacity correction table × Long connection pipe correction coefficient of the longest indoor unit distance
 - ◆ When the configuration ratio of indoor unit reaches 100%
 Maximum outdoor unit capacity = Capacity of the corresponding configuration ratio in the outdoor unit capacity correction table × Long connection pipe correction coefficient of the longest indoor unit distance

6.3 Frosting Correction Factors of Heating

When the outdoor environment meets certain conditions (temperature and humidity conditions), the unit may be frosted or defrosted. In this case, the heating capacity of the whole system will be reduced. Therefore, the frosting correction factor should also be calculated in heating load selection for the whole system.

The table below provides the frosting correction factors:

Air inlet dry bulb temperature (°F(°C)/RH85%) of the outdoor heat exchanger	12.2(-11)	15.8(-9)	19.4(-7)	23(-5)	26.6(-3)	32.0(0)	37.4(3)	41.0(5)	44.6(7)
Frosting (defrosting) capacity correction factor of the whole system	1.00	0.99	0.98	0.95	0.88	0.86	0.93	0.96	1.00

7 UNIT NOISE CURVES

7.1 Outdoor Unit Noise Curve

Noise test method:

Test environment: semi-anechoic room; the noise level will be slightly higher due to change of the environment during actual operation.

The test points of the following noise curves are shown below:

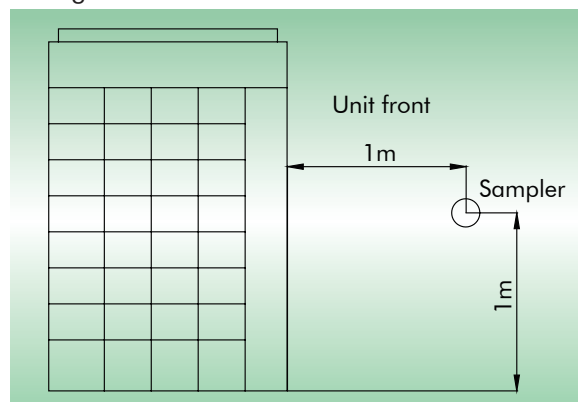

6 Ton noise evaluation curve

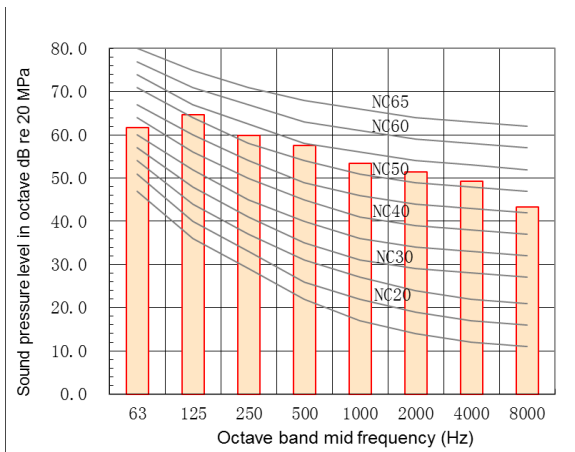

8 Ton noise evaluation curve

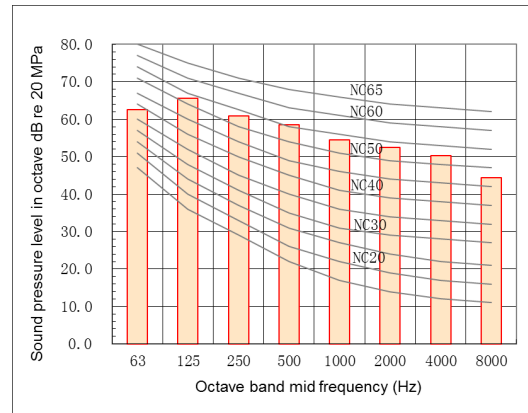

10 Ton noise evaluation curve

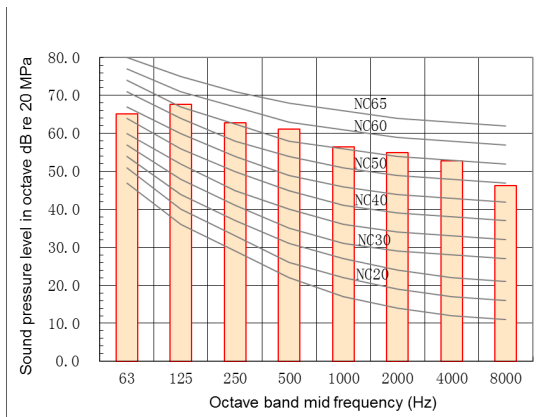

12 Ton noise evaluation curve

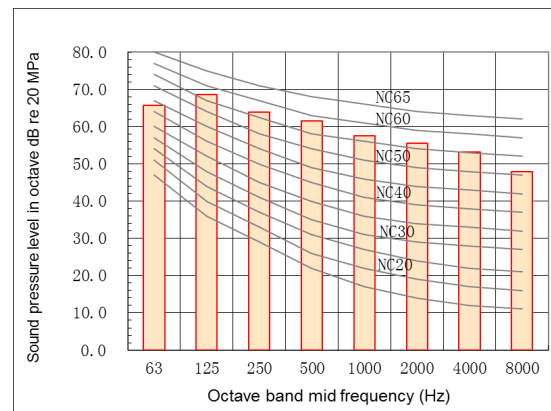

14 Ton noise evaluation curve

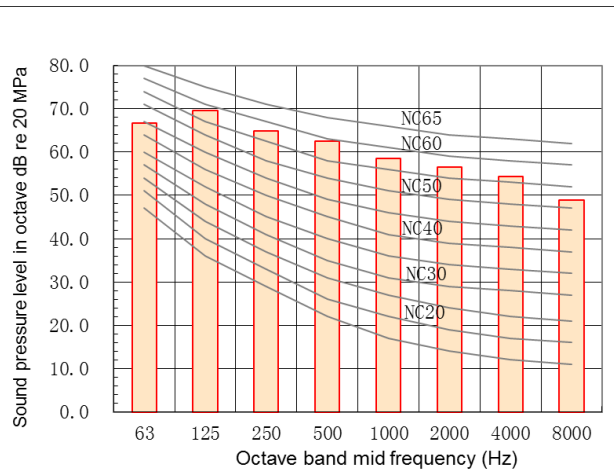

8 UNIT GRAVITY CENTER DIAGRAMS

Unit: mm(in.)

GMV-72WM/B-F(U) and GMV-72WM/B-U(U)

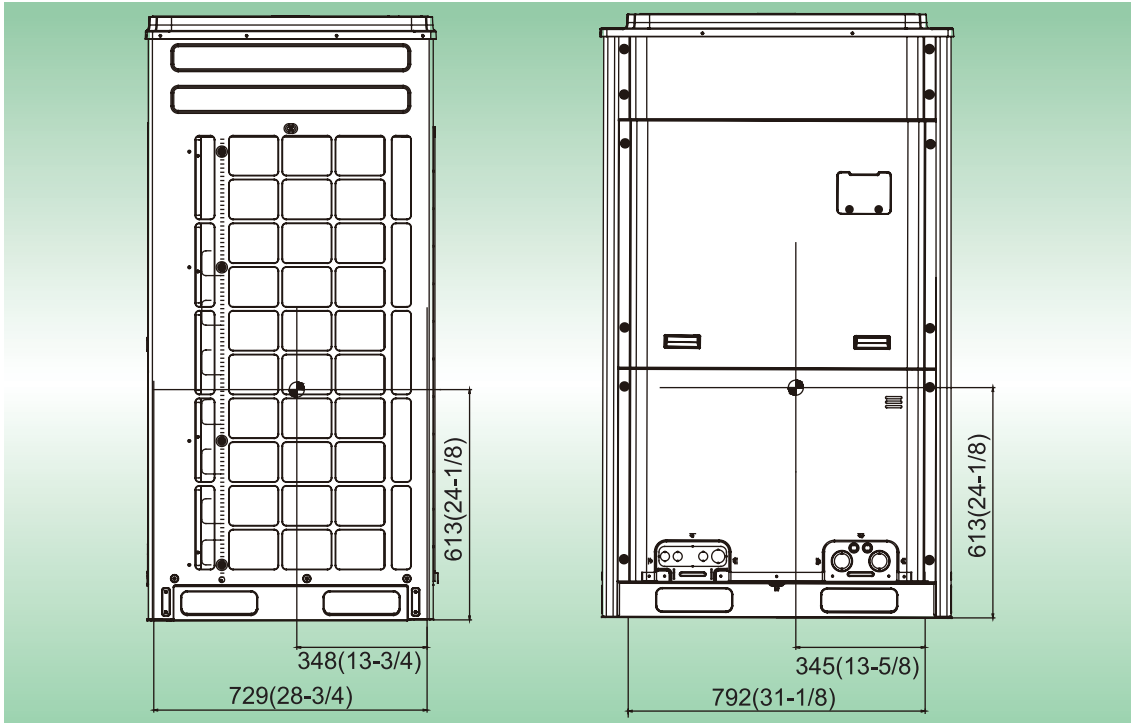

GMV-96WM/B-F(U), GMV-120WM/B-F(U), GMV-120WM/B-U(U) and GMV-144WM/B1-F(U)

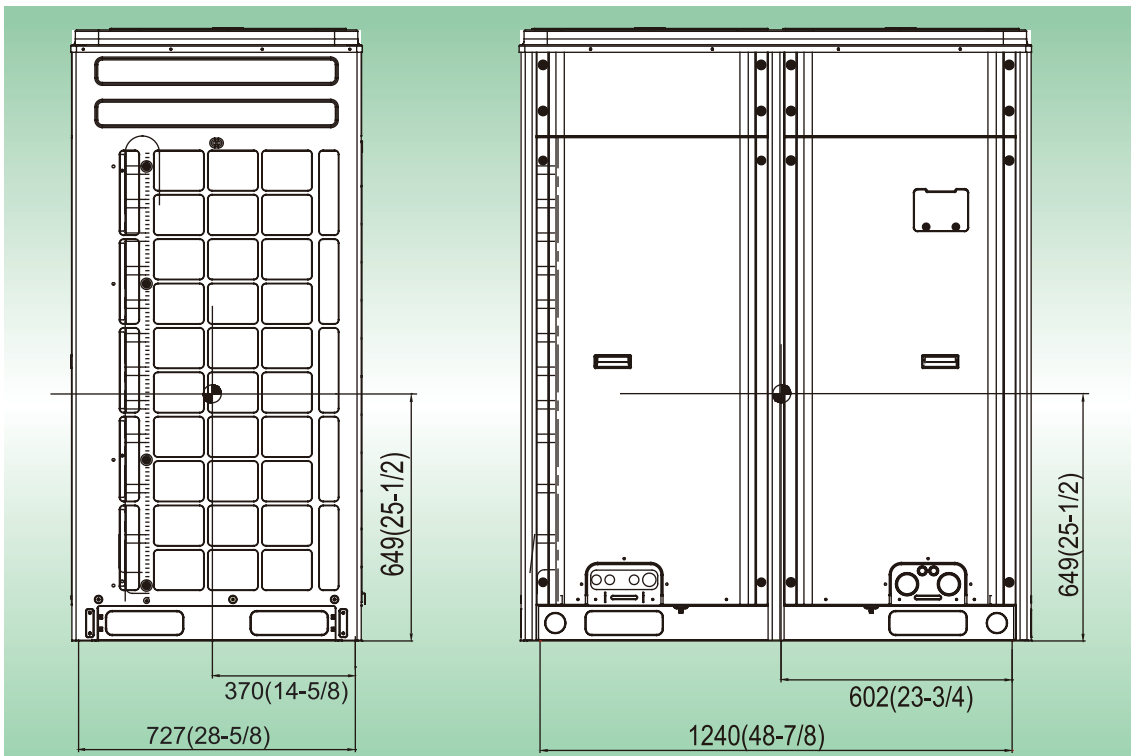

GMV5 DC Inverter VRF Units Technical Sales Guide

GMV-168WM/B1-F(U)

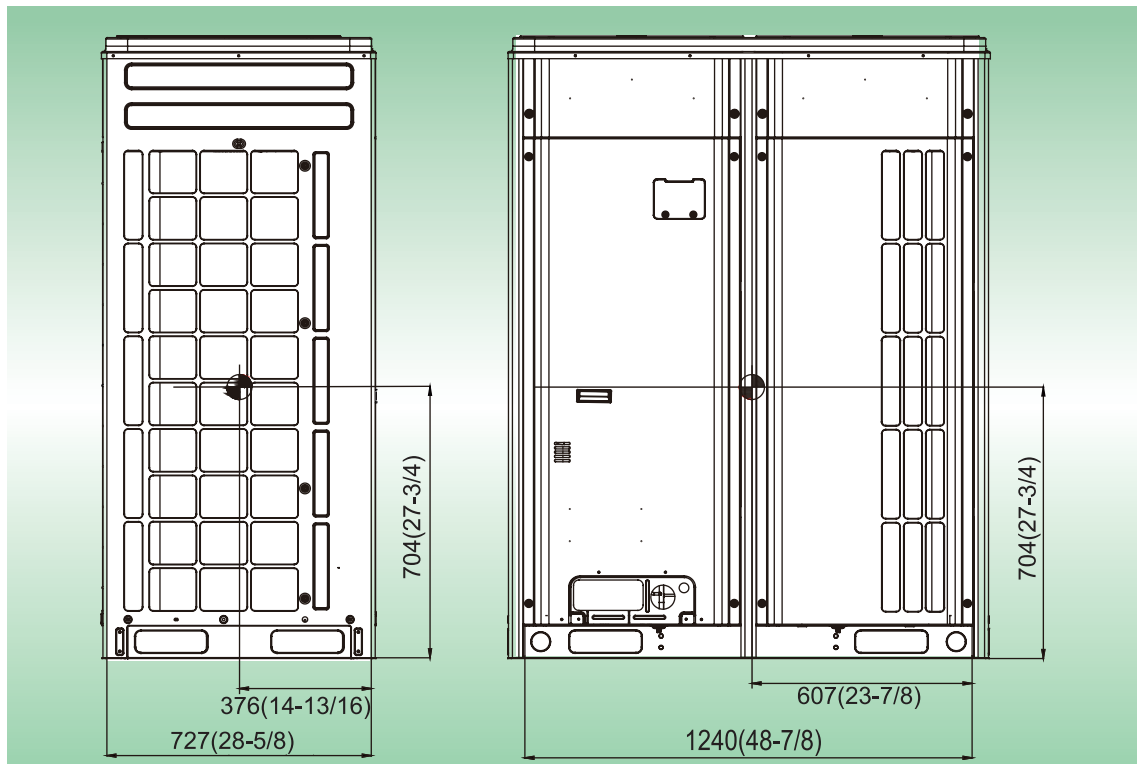

9 UNIT INSTALLATION SPACE REQUIREMENTS

9.1 Selection of outdoor unit installation site

VRF units are used in a lot of situations and serve wider users. If the unit is installed in a living environment, the cooling, heating and noise requirements will be higher, especially for the aged and infants. Therefore, the indoor/outdoor unit model with sufficient capacity and low noise should be preferred during model selection. It is not advisable to install the outdoor unit outside the bedroom, study room, or meeting room. For the commercial site, it is improper to install the outdoor unit near the office.

9.2 External dimensions and mounting hole dimensions of the outdoor unit

Unit: mm(in.)

External and installation dimensions of GMV-72WM/B-F(U) and GMV-72WM/B-U(U):

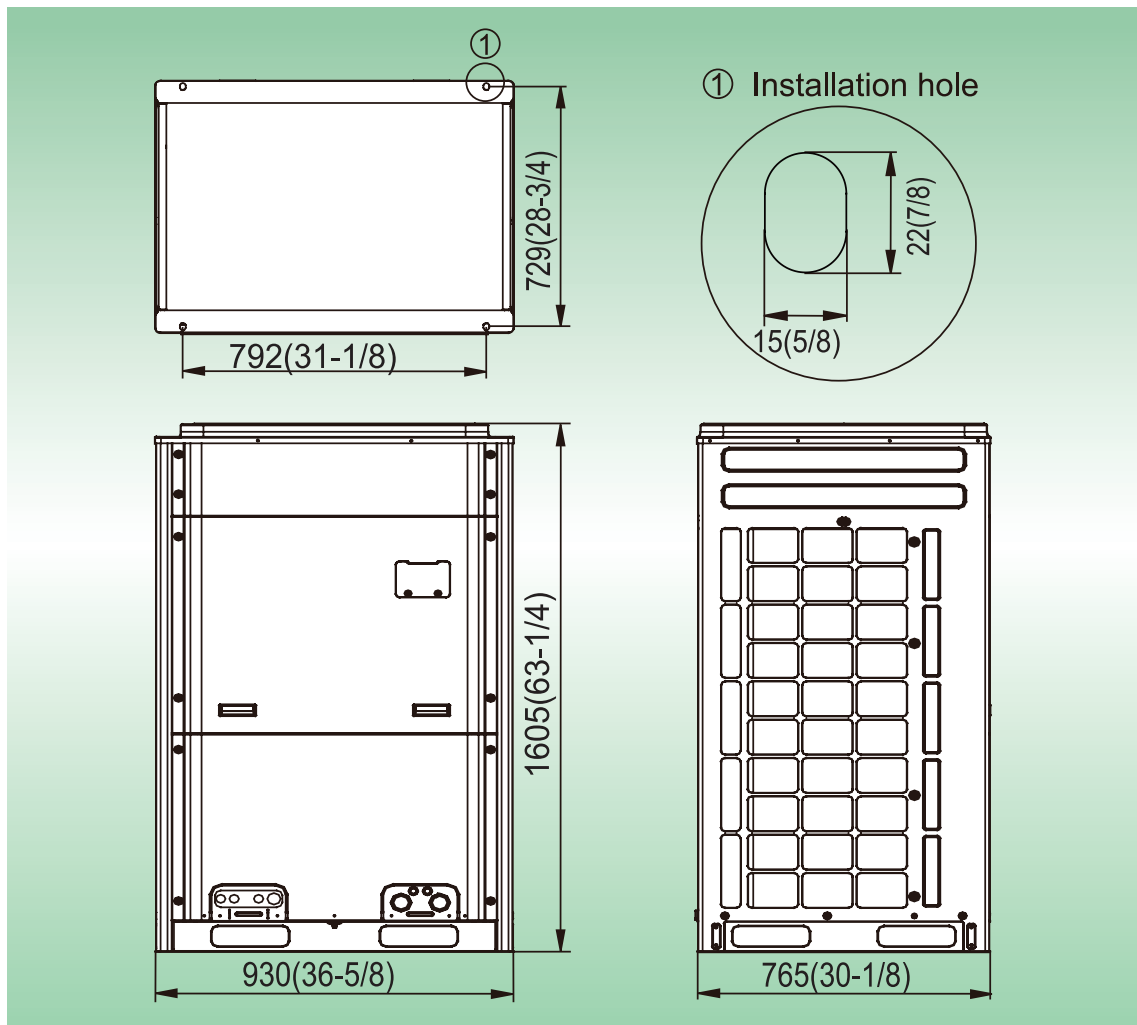

External and installation dimensions of GMV-96WM/B-F(U), GMV-120WM/B-F(U), GMV-144WM/B1-F(U), and GMV-120WM/B-F(U):

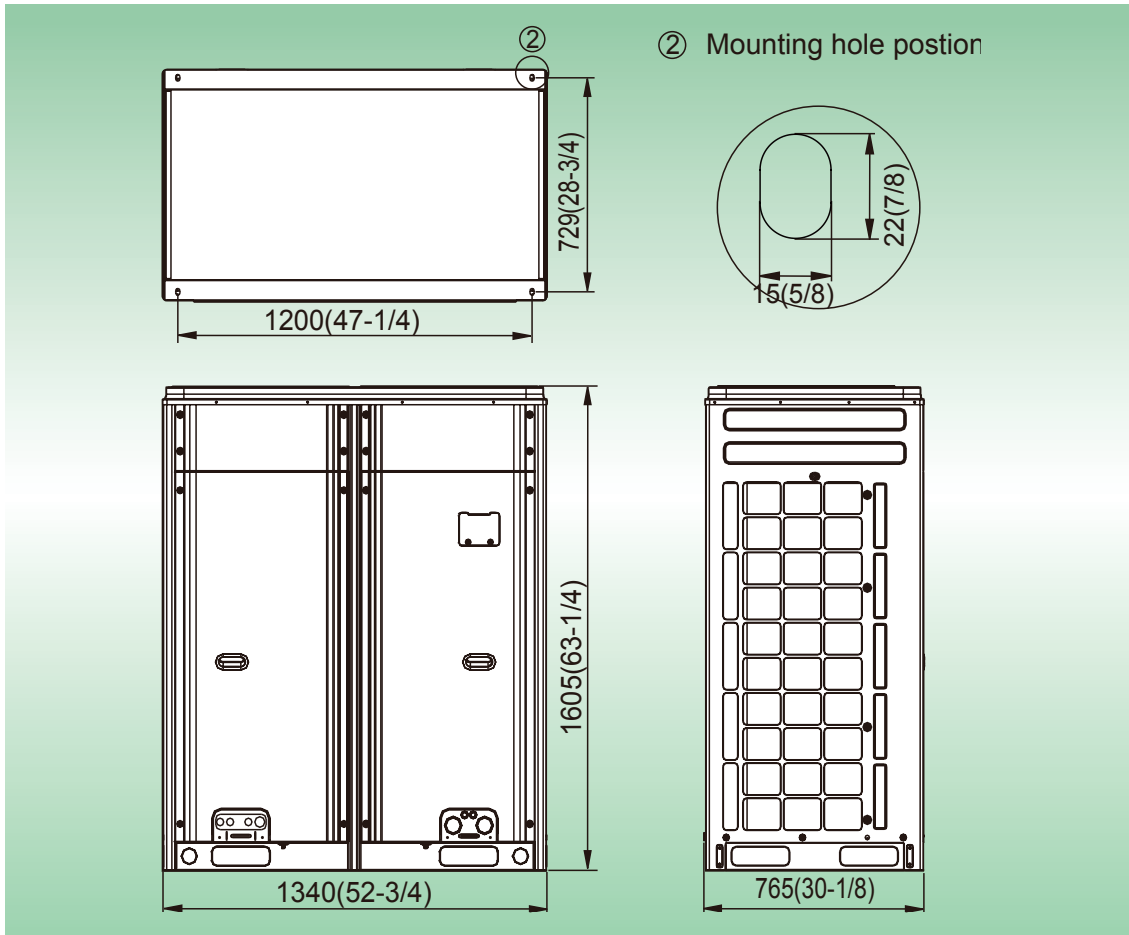

External and installation dimensions of GMV-168WM/B1-F(U):

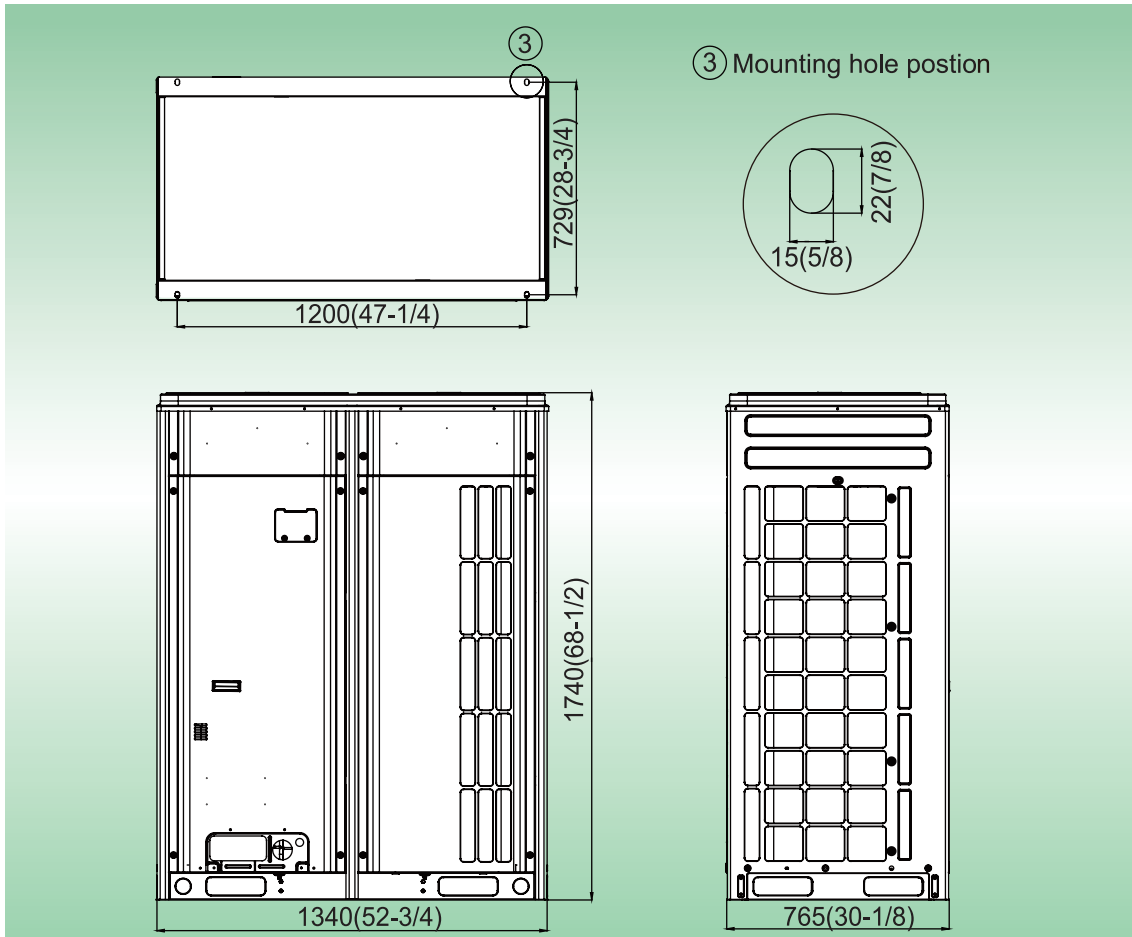

9.3 External unit installation space requirements

Unit: mm(in.)

1) If all sides of the outdoor unit (including the top) are surrounded by walls, process according to the following requirements for installation space:

Installation space requirements for the single-module unit

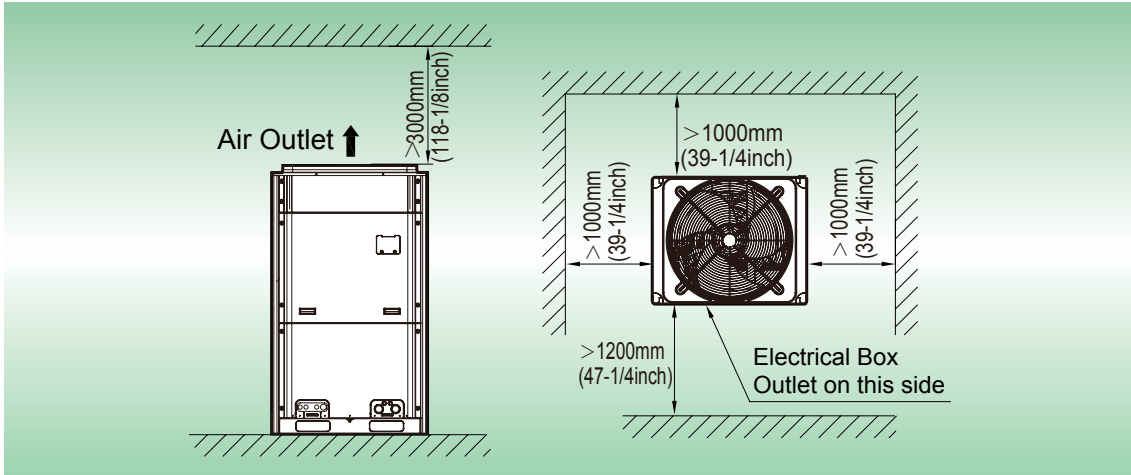

Installation space requirements for the dual-module unit

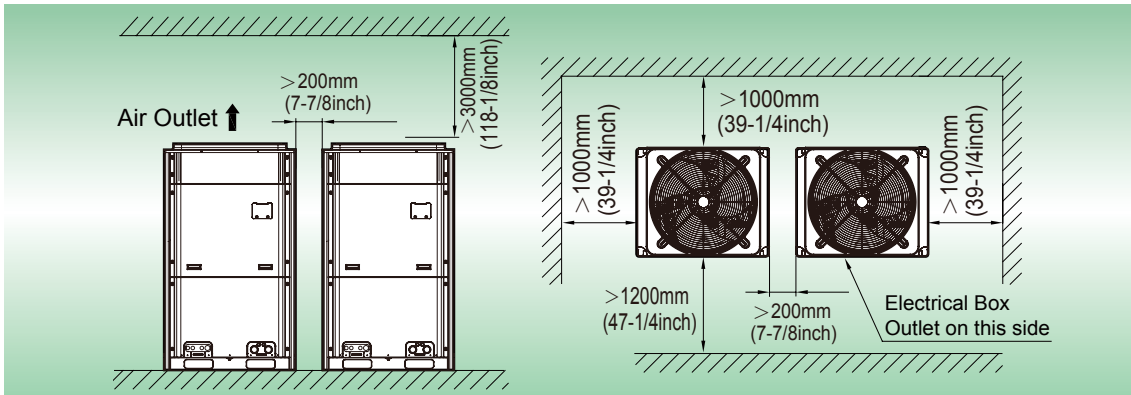

Installation space requirements for triple-module unit

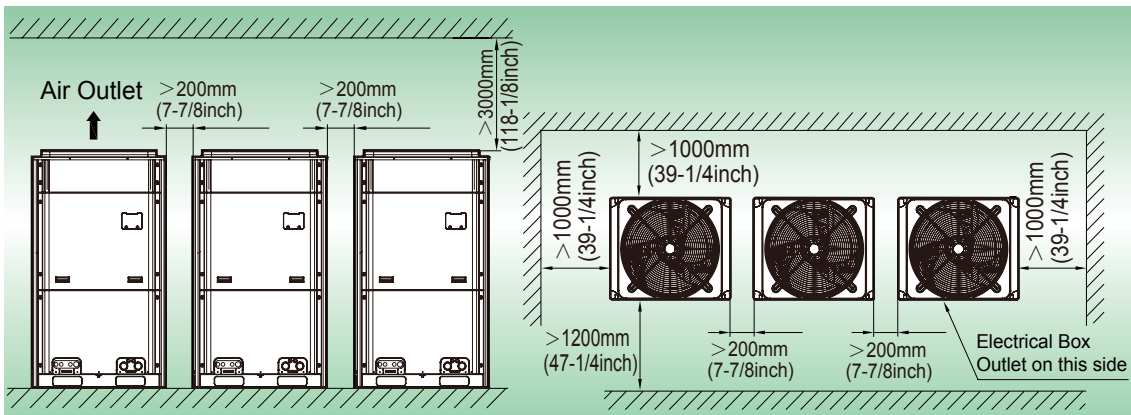

2) When there is wall (or similar obstruction) above the unit, keep the distance between the unit top and the wall at least 3000mm (118-1/8inch) or above. When the unit is located in a totally open space with no obstructions in four directions, keep the distance between the unit top and wall at least

1500mm(59inch) or above (See Fig.a). When space is limited within 1500mm(59inch) or the unit is not set in an open space, air outlet pipe is required to be installed in order to keep good ventilation (See Fig.b)

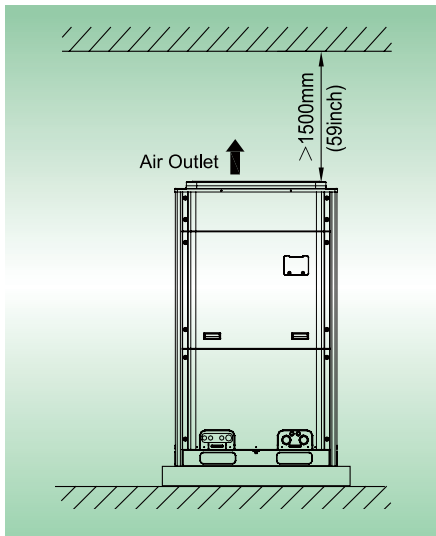

Figure (a)

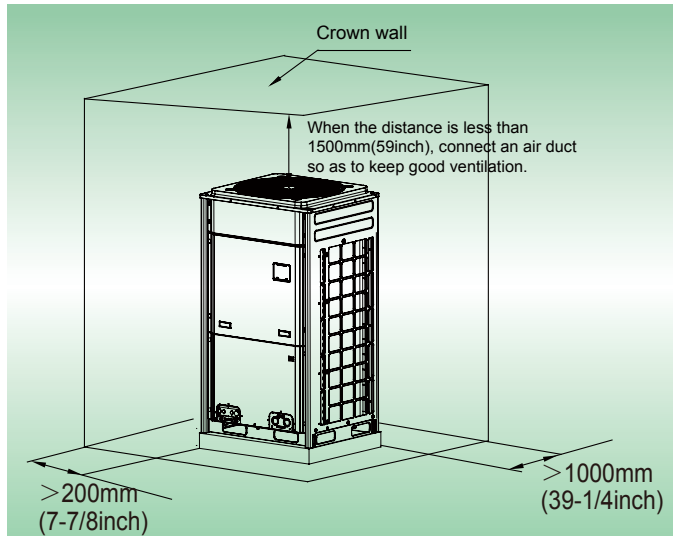
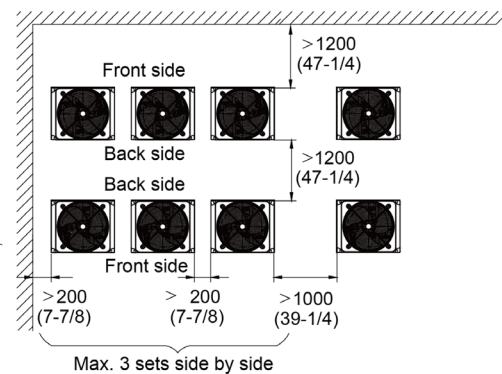
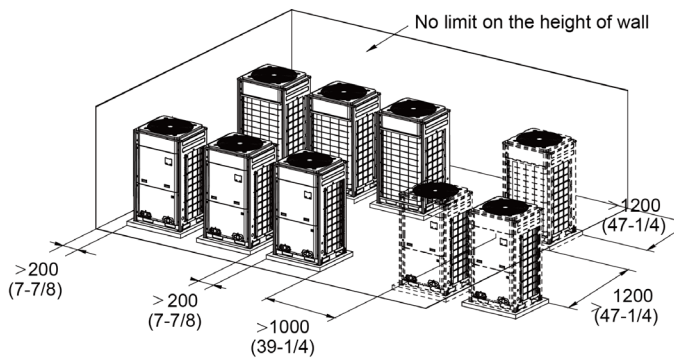
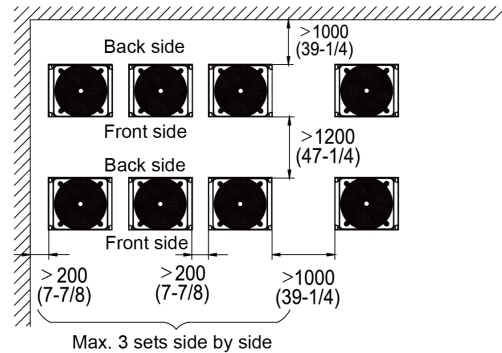
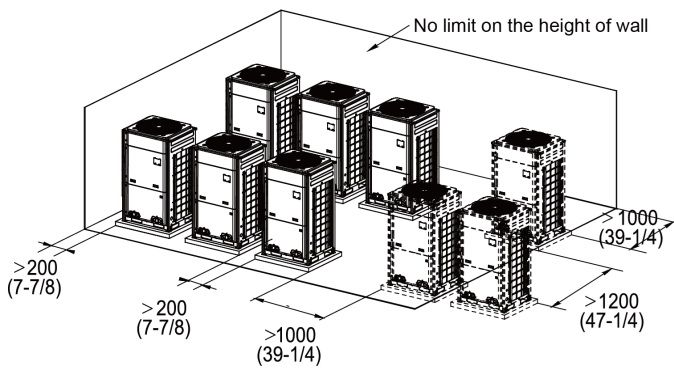

Figure (b)

Installation space requirements of multiple outdoor units

To ensure smooth ventilation, an open space must be ensured above the unit top, and there is no barrier against wind.

If there is an open space at the front side and left side (or right side) of the outdoor unit, the units should be installed towards the same direction or reverse direction.



3) Considering the seasonal wind in outdoor unit installation
 Anti-monsoon installation requirement for unit not connecting exhaust duct

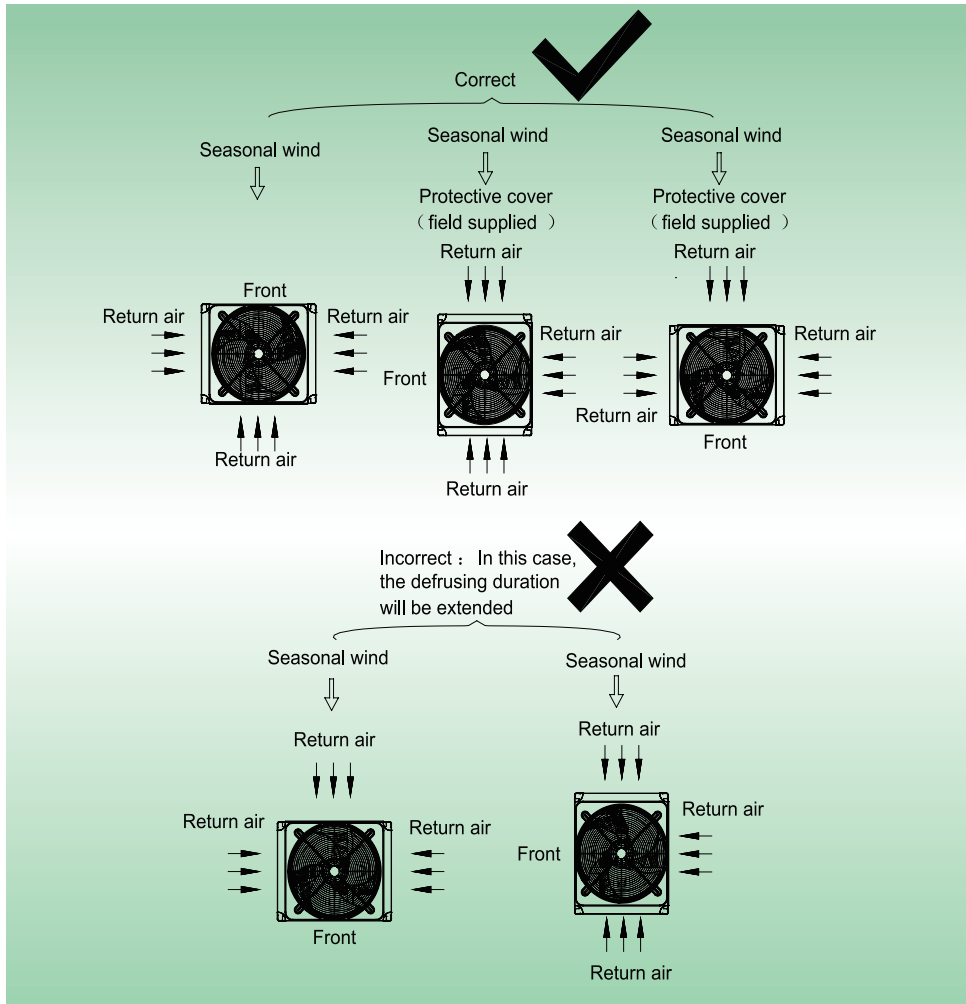

Anti-monsoon installation requirement for unit connecting exhaust duct

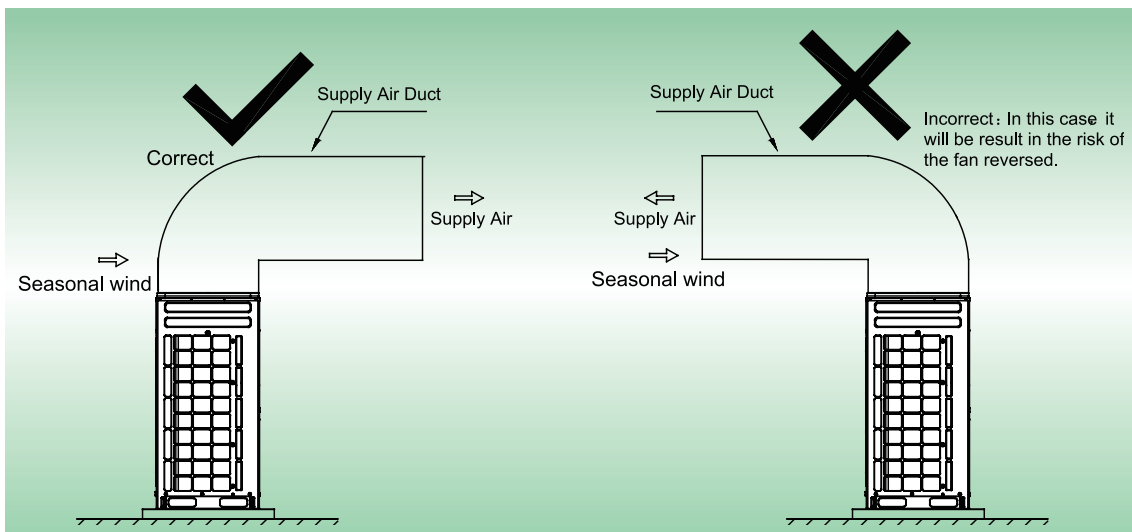

4) Considering snow in outdoor unit installation

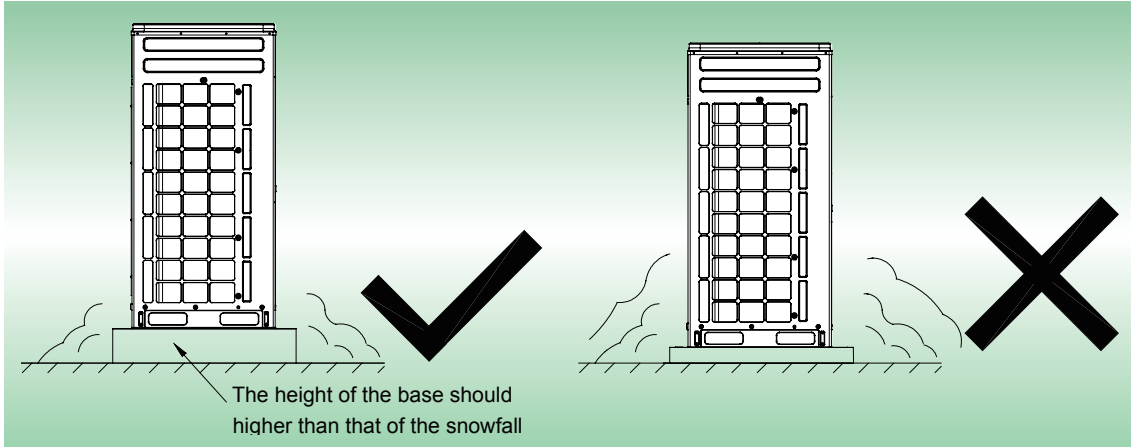

5) When the outdoor unit is installed on equipment, an air exhaust pipe should be connected, the aperture opening ratio of the louver cannot be smaller than 80%, and the included angle between the louver and the horizontal plane should be smaller than 20°.

10 MODEL SELECTION FOR UNIT PIPING

10.1 Schematic Diagram of Piping Connection

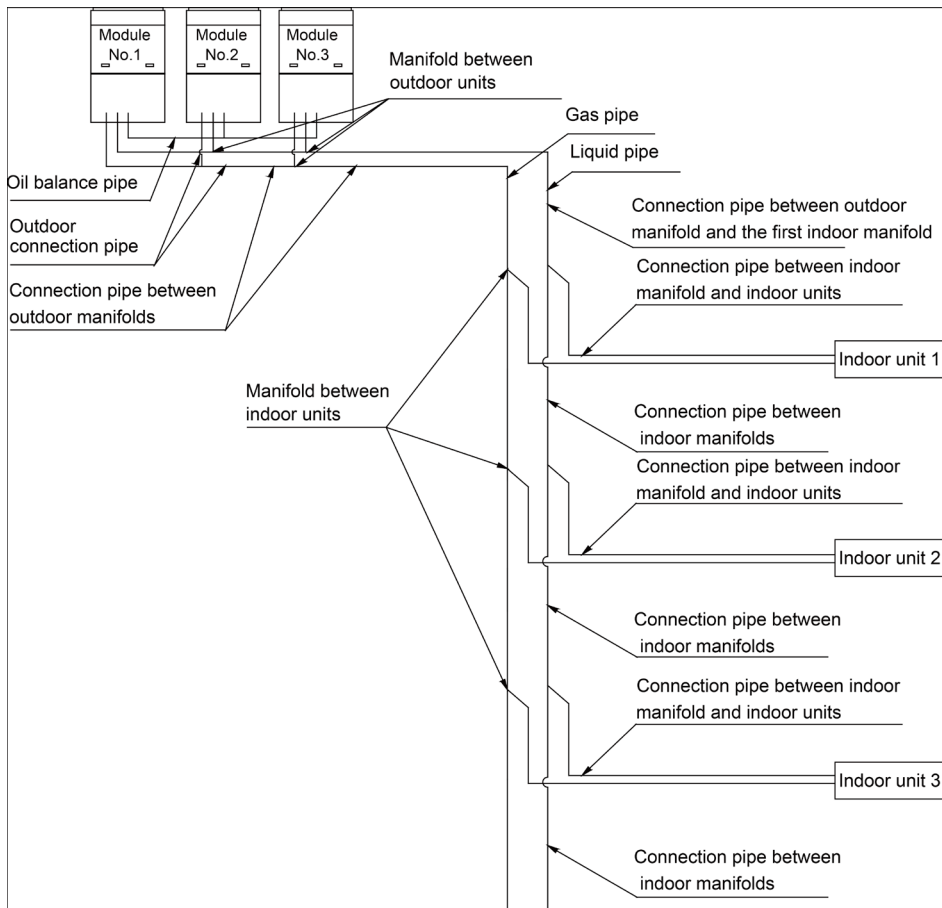

Schematic Diagram of Piping Sequence
GMV-72WM/B-F(U), GMV-72WM/B-U(U)

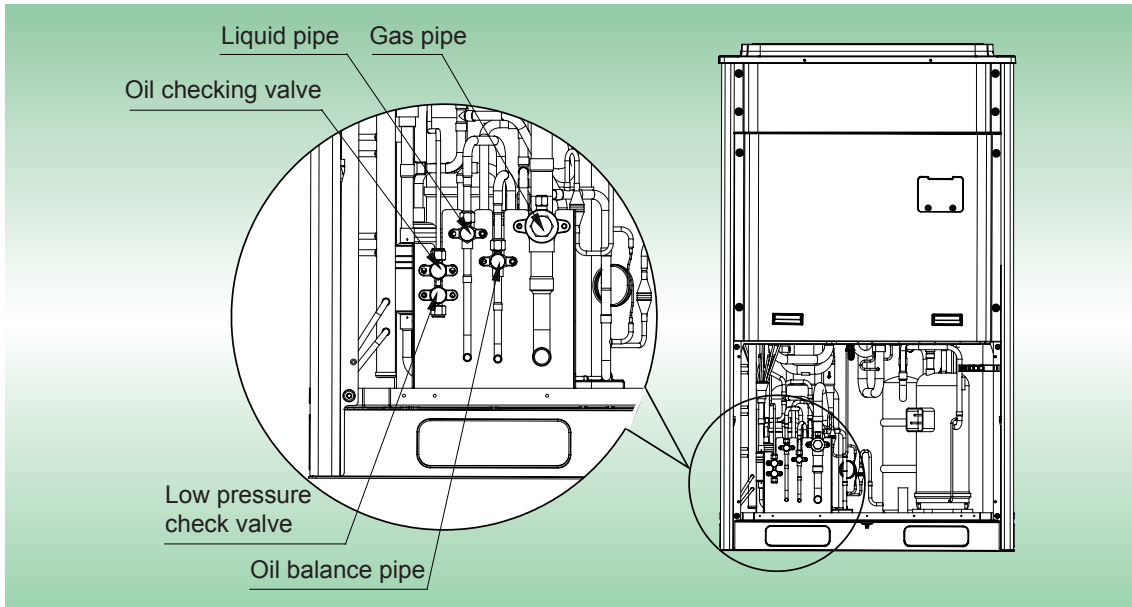

GMV-96WM/B-F(U), GMV-120WM/B-F(U), GMV-120WM/B-U(U) and GMV-144WM/B1-F(U)

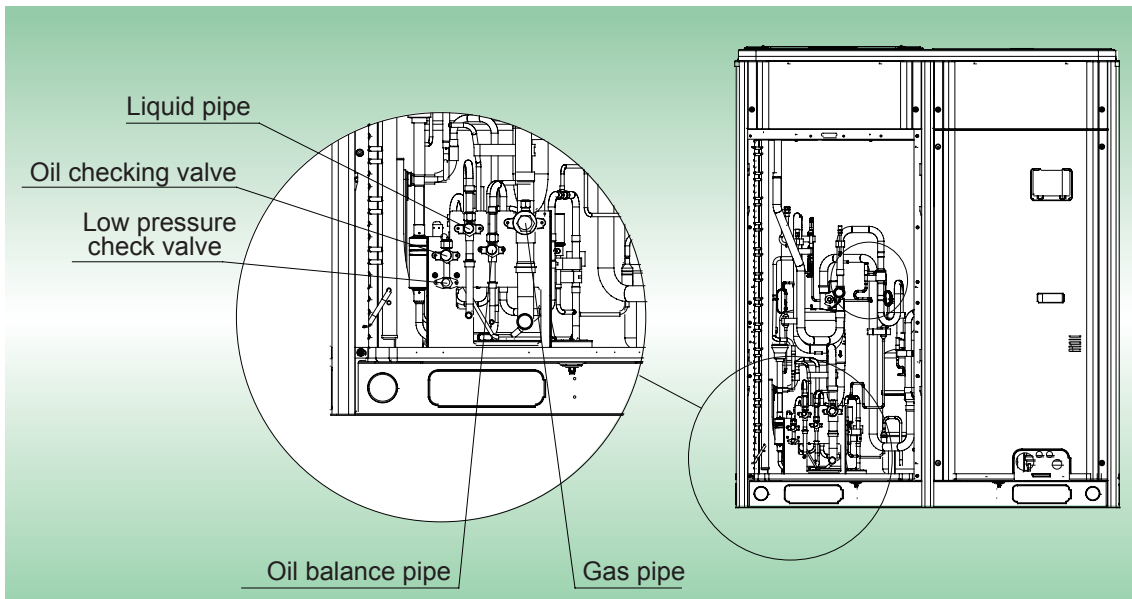

GMV-168WM/B1-F(U)

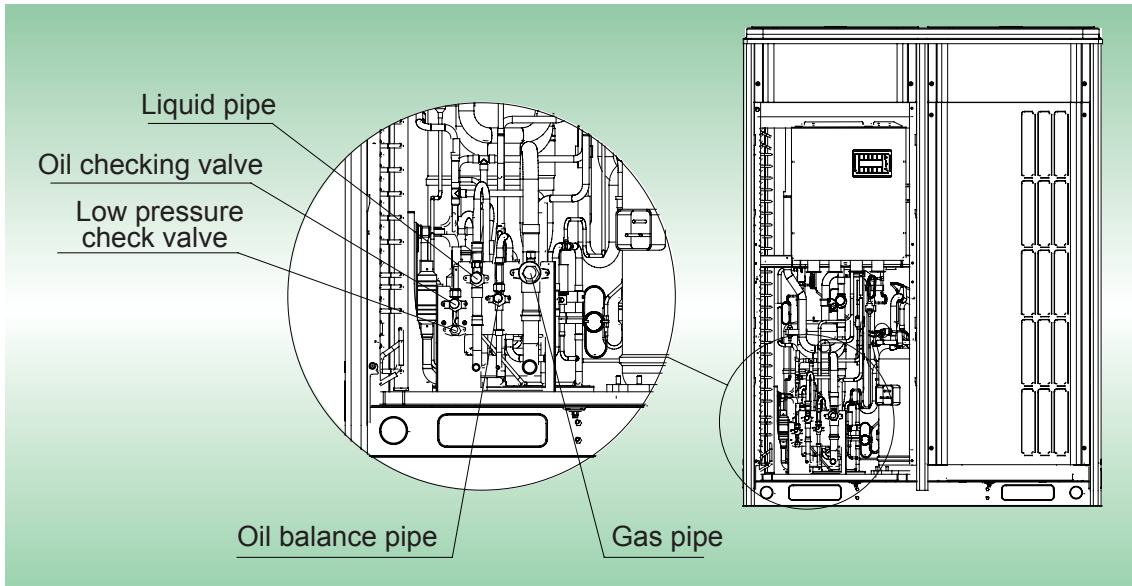

10.2 Allowable pipe length and drop height among indoor and outdoor units

Unit: m(ft.)

Y type branch joint is adopted to connect indoor and outdoor units. Connecting method is shown in the figure below.

Remark: Equivalent length of one Y-type manifold is about 0.5m(1-3/4inch).

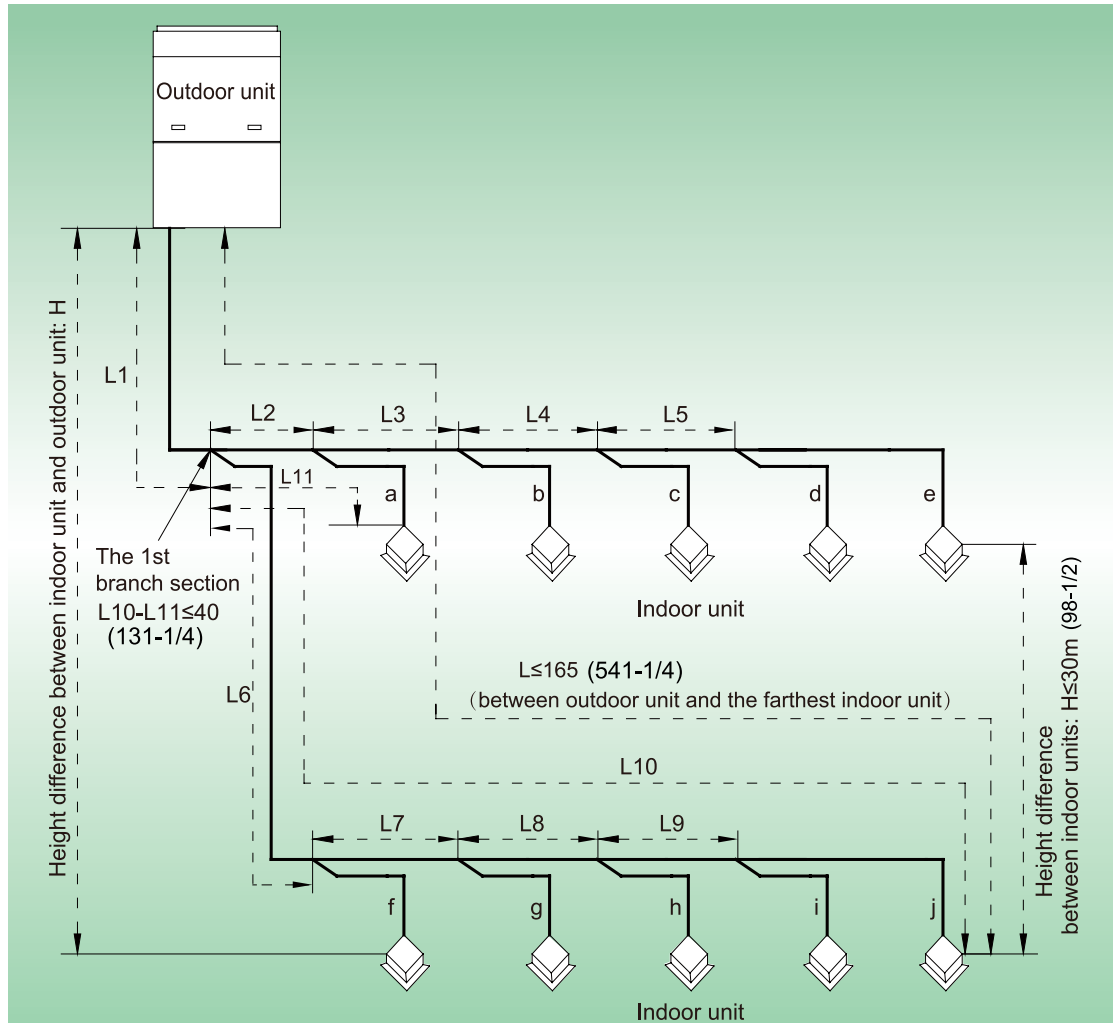

L10: Length from the first branch to the farthest IDU; L11: Length from the first branch to the nearest IDU; Equivalent length of branch of IDU is 0.5m (1-3/4feet).

R410A Refrigerant System		Allowable Value m(feet)	Fitting Pipe
Total length (actual length) of fitting pipe		≤ 1000(3280-4/5)	L1+L2+L3+L4+...+L9+a+b+...+i+j
Length of farthest fitting pipe(m)	Actual length	≤ 165(541-1/4)	L1+L6+L7+L8+L9+j
	Equivalent length	≤ 190(623-1/4)	
Difference between the pipe length from the first branch of IDU to the farthest IDU and the pipe length from the first branch of IDU to the nearest IDU		≤ 40(131-1/4)	L10-L11
Equivalent length from the first branch to the furthest piping (1)		≤ 40(131-1/4)	L6+L7+L8+L9+j
Height difference between outdoor unit and indoor unit	Outdoor unit at upper(2)	≤ 90(295-1/4)	—
	Outdoor unit at lower(2)	≤ 90(295-1/4)	—
Height difference between indoor units (m)		≤ 30(98-1/2)	—
Maximum length of Main pipe(3)		≤ 90(295-1/4)	L1
From IDU to its nearest branch (4)		≤ 40(131-1/4)	a,b,c,d,e,f,g,h,i,j

CAUTION:

During model selection and design process, if above requirements are all met, pipe size must be adjusted correspondingly, otherwise system's capacity may be reduced or not evenly distributed, and may even affect the reliability of the complete unit.

10.3 Connection Pipe among Outdoor Modules

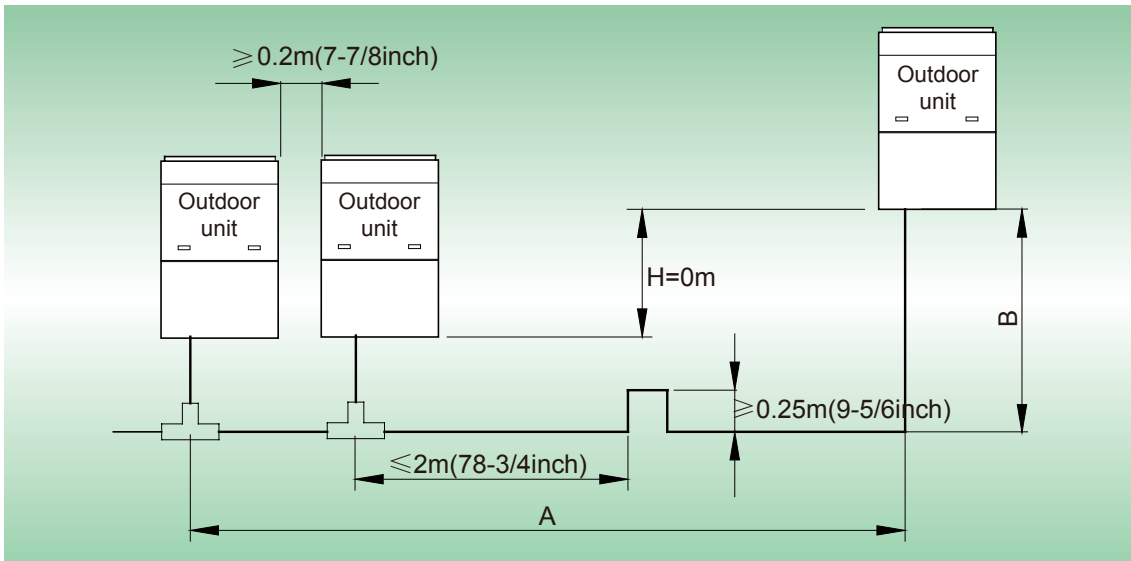
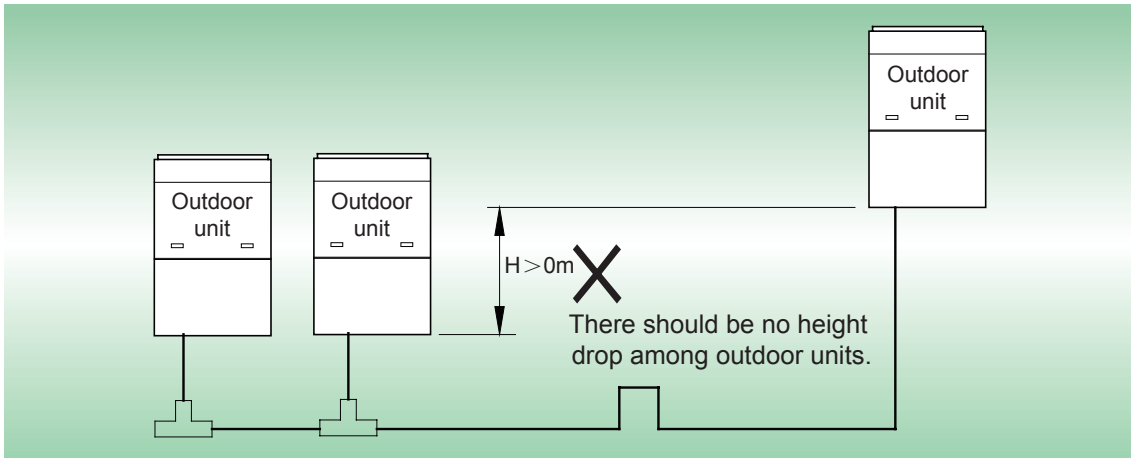

NOTICES: When the distance between outdoor units exceeds 2m(6-5/9feet), U-type oil trap should be added at low-pressure gas pipe. $A + B \leq 10m(32-4/5feet)$.

The pipeline between outdoor units should be installed as follows:

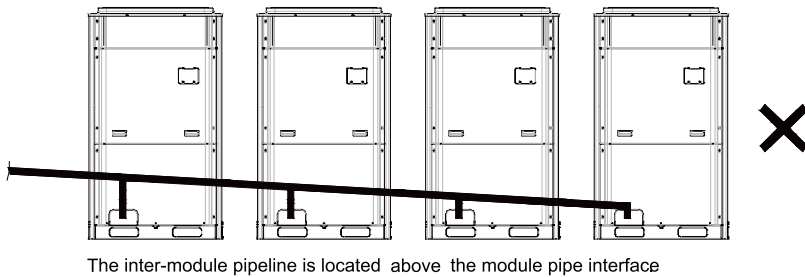
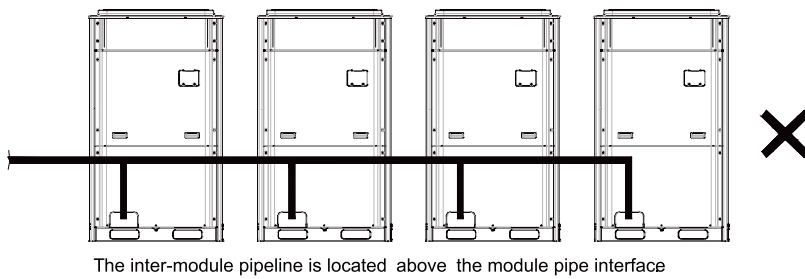
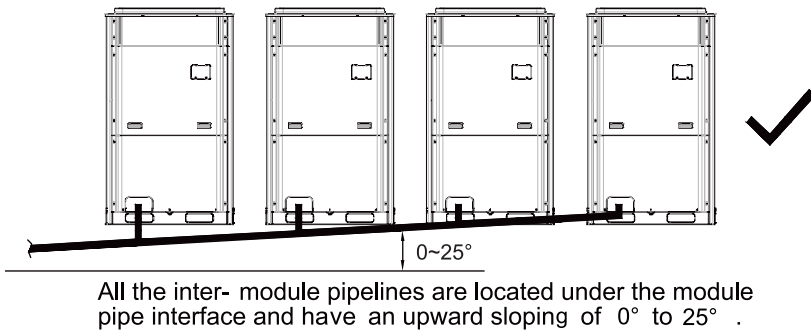
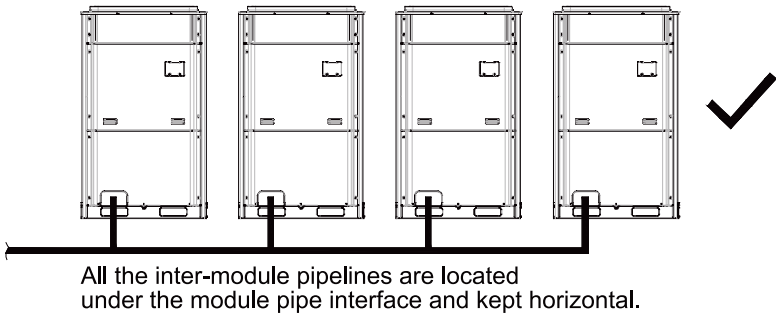
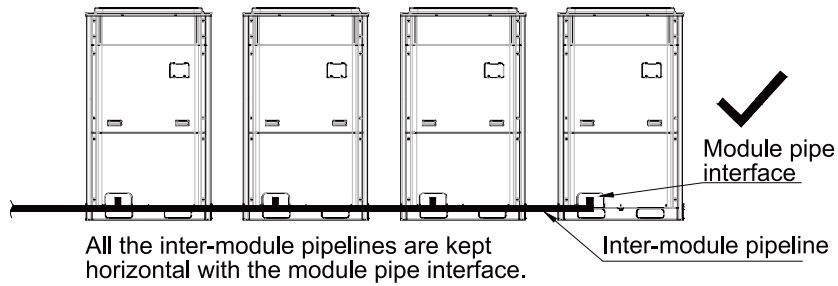

10.4 Fitting pipe between Outdoor Unit and the First Manifold

1) For single module system, pipe size (between outdoor unit and the first manifold) is determined by that of outdoor unit.

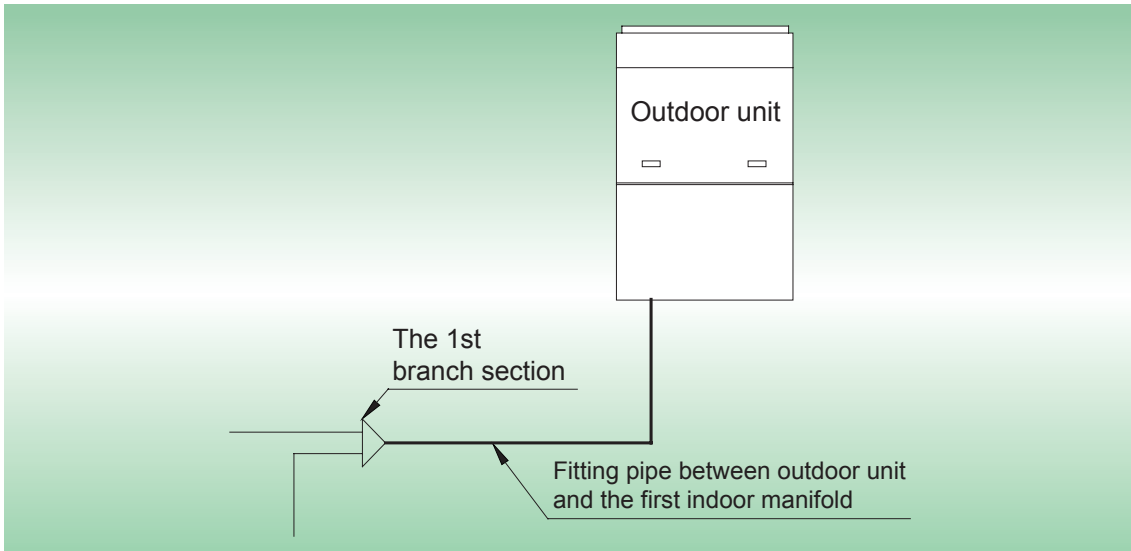

Pipe size of basic outdoor module is shown as follows:

Basic Module		Pipe between ODU and the first branch of IDU	
		Gas Pipe mm(in.)	Liquid Pipe mm(in.)
GMV-72WM/B-F(U)	GMV-72WM/B-U(U)	Φ19.05(3/4)	Φ9.52(3/8)
GMV-96WM/B-F(U)	GMV-96WM/B-U(U)	Φ22.2(7/8)	Φ9.52(3/8)
GMV-120WM/B-F(U)	GMV-120WM/B-U(U)	Φ28.6(1-1/8)	Φ12.7(1/2)
GMV-144WM/B1-F(U)	—	Φ28.6(1-1/8)	Φ12.7(1/2)
GMV-168WM/B1-F(U)	—	Φ28.6(1-1/8)	Φ15.9(5/8)

2) For multi-module unit, select appropriate manifold connected to outdoor module as per the pipe size of basic module. Pipe size of basic outdoor module is shown as follows:

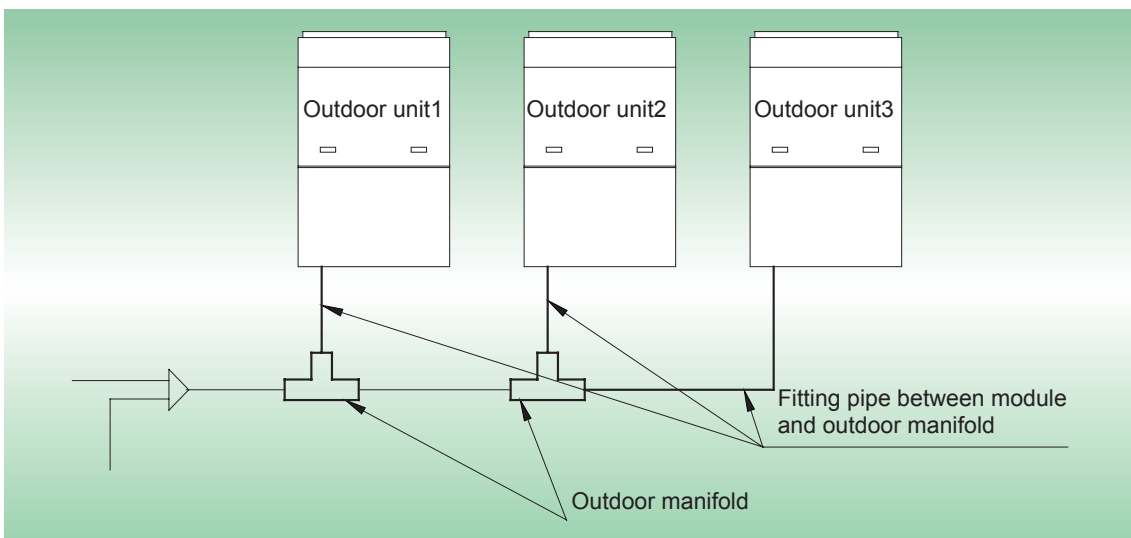

Basic Module		Pipe between module and branch of ODU	
		Gas Pipe mm(in.)	Liquid Pipe mm(in.)
GMV-72WM/B-F(U)	GMV-72WM/B-U(U)	Φ19.05(3/4)	Φ9.52(3/8)
GMV-96WM/B-F(U)	GMV-96WM/B-U(U)	Φ22.2(7/8)	Φ9.52(3/8)
GMV-120WM/B-F(U)	GMV-120WM/B-U(U)	Φ28.6(1-1/8)	Φ12.7(1/2)
GMV-144WM/B1-F(U)	—	Φ28.6(1-1/8)	Φ12.7(1/2)
GMV-168WM/B1-F(U)	—	Φ28.6(1-1/8)	Φ15.9(5/8)

Select the branch of outdoor module

	Model
Select the branch of outdoor module	ML01/A

3) Fitting pipe between two manifolds from basic modules

Pipe size (between two manifolds from basic modules) is based on the total capacity of upstream modules.

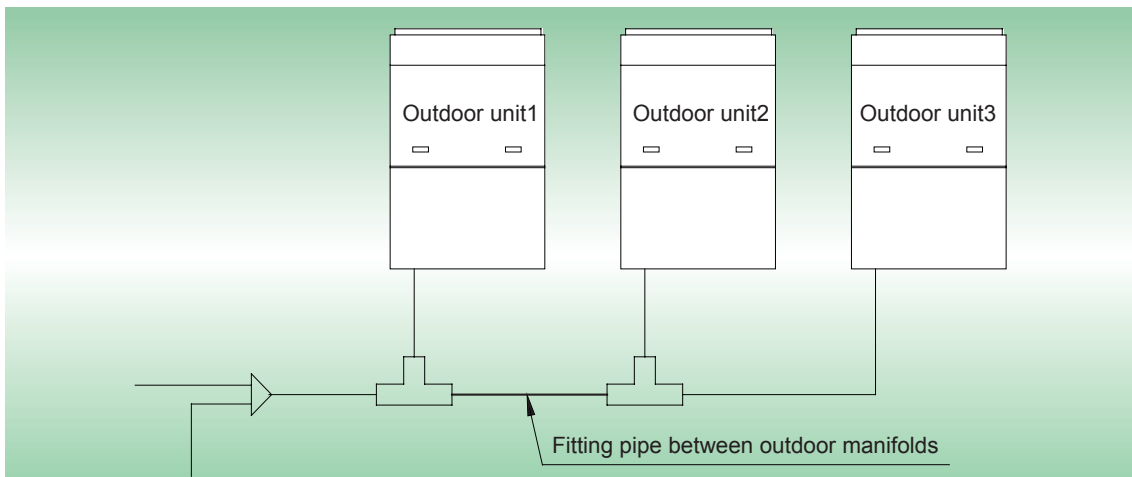

Total capacity of upstream modules Q(Btu/h)	Pipe size between manifolds	
	Gas pipe size mm(in.)	Liquid pipe size mm(in.)
144000	Φ28.6(1-1/8)	Φ12.7(1/2)
168000	Φ28.6(1-1/8)	Φ15.9(5/8)
192000	Φ28.6(1-1/8)	Φ15.9(5/8)
216000	Φ28.6(1-1/8)	Φ15.9(5/8)
240000	Φ34.9(1-3/8)	Φ15.9(5/8)

Total capacity of upstream modules Q(Btu/h)	Pipe size between manifolds	
	Gas Pipe mm(inch)	Liquid Pipe mm(inch)
$Q \leq 72000$	Φ19.05(3/4)	Φ9.52(3/8)
$72000 < Q \leq 96000$	Φ22.2(7/8)	Φ9.52(3/8)
$96000 < Q \leq 144000$	Φ28.6(1-1/8)	Φ12.7(1/2)
$144000 < Q \leq 216000$	Φ28.6(1-1/8)	Φ15.9(5/8)
$216000 < Q \leq 240000$	Φ34.9(1-3/8)	Φ15.9(5/8)
$240000 < Q \leq 336000$	Φ34.9(1-3/8)	Φ19.05(3/4)
$336000 < Q$	Φ41.3(1-5/8)	Φ19.05(3/4)

4) Fitting pipe between the first manifold from indoor unit and the end manifold from outdoor unit Single module unit

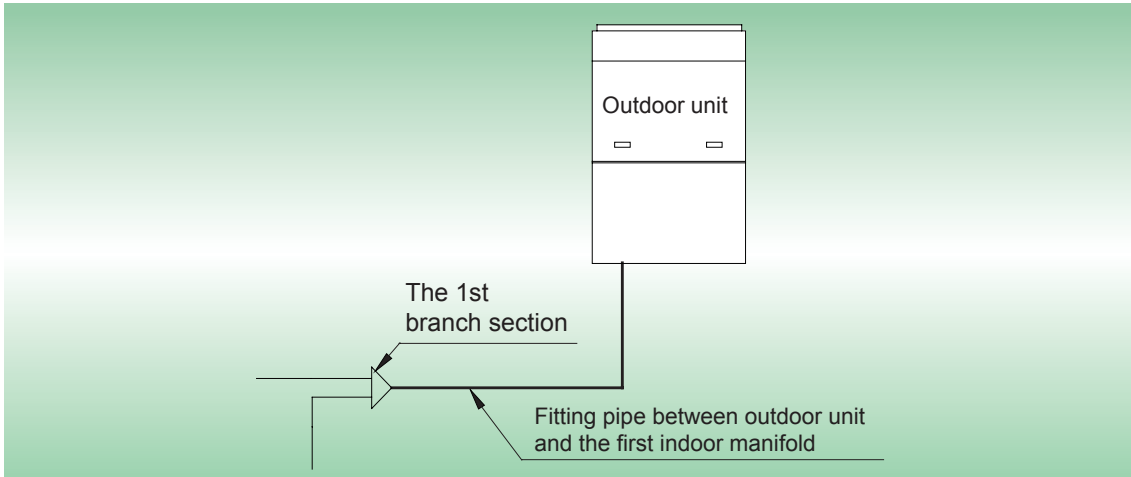

Basic Module		Pipe between ODU and the first branch of IDU	
		Gas Pipe mm(in.)	Liquid Pipe mm(in.)
GMV-72WM/B-F(U)	GMV-72WM/B-U(U)	Φ19.05(3/4)	Φ9.52(3/8)
GMV-96WM/B-F(U)	GMV-96WM/B-U(U)	Φ22.2(7/8)	Φ9.52(3/8)
GMV-120WM/B-F(U)	GMV-120WM/B-U(U)	Φ28.6(1-1/8)	Φ12.7(1/2)
GMV-144WM/B1-F(U)	—	Φ28.6(1-1/8)	Φ12.7(1/2)
GMV-168WM/B1-F(U)	—	Φ28.6(1-1/8)	Φ15.9(5/8)

For multiple modules, the piping from ODU to the first branch of IDU is based on the total rated capacity of outdoor modules.

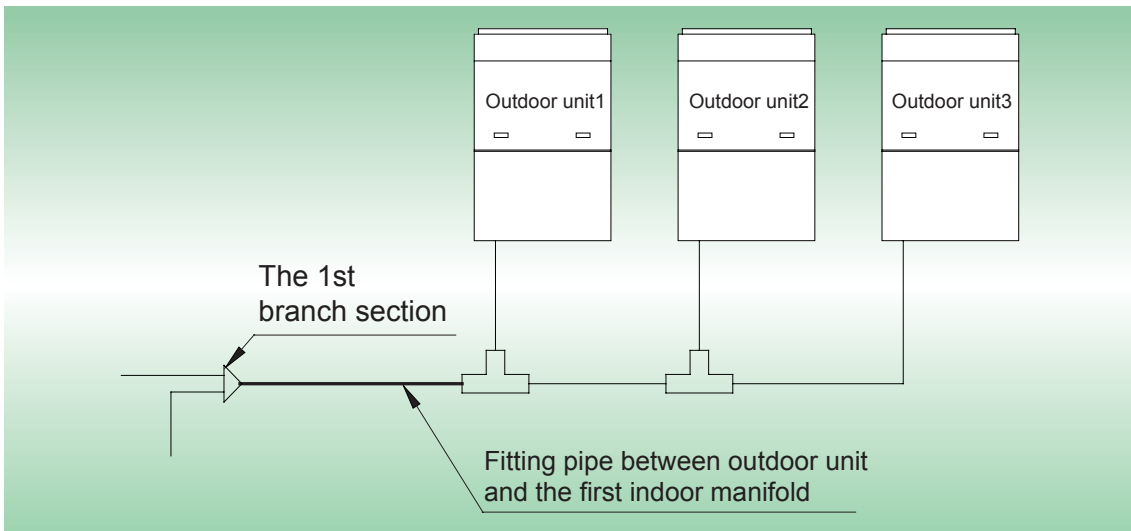

Total rated capacity of outdoor modules (multi-modular system)		Pipe between ODU and the first branch of IDU	
		Gas pipe size mm(in.)	Liquid pipe size mm(in.)
GMV-144WM/B-F(U)	GMV-144WM/B-U(U)	Φ28.6(1-1/8)	Φ12.7(1/2)
GMV-168WM/B-F(U)	GMV-168WM/B-U(U)	Φ28.6(1-1/8)	Φ15.9(5/8)
GMV-192WM/B-F(U)	GMV-192WM/B-U(U)	Φ28.6(1-1/8)	Φ15.9(5/8)
GMV-216WM/B-F(U)	GMV-216WM/B-U(U)	Φ28.6(1-1/8)	Φ15.9(5/8)
GMV-240WM/B-F(U)	GMV-240WM/B-U(U)	Φ34.9(1-3/8)	Φ15.9(5/8)

Total rated capacity of outdoor modules (multi-modular system)		Pipe between ODU and the first branch of IDU	
		Gas pipe size mm(in.)	Liquid pipe size mm(in.)
GMV-264WM/B-F(U)	GMV-264WM/B-U(U)	Φ34.9(1-3/8)	Φ19.05(3/4)
GMV-288WM/B-F(U)	GMV-288WM/B-U(U)	Φ34.9(1-3/8)	Φ19.05(3/4)
GMV-312WM/B-F(U)	GMV-312WM/B-U(U)	Φ34.9(1-3/8)	Φ19.05(3/4)
GMV-336WM/B-F(U)	GMV-336WM/B-U(U)	Φ34.9(1-3/8)	Φ19.05(3/4)
GMV-360WM/B-F(U)	GMV-360WM/B-U(U)	Φ41.3(1-5/8)	Φ19.05(3/4)

5) Manifold at indoor unit side

Manifold at indoor unit side can be selected as per total capacity of downstream indoor unit(s). Refer to the following table.

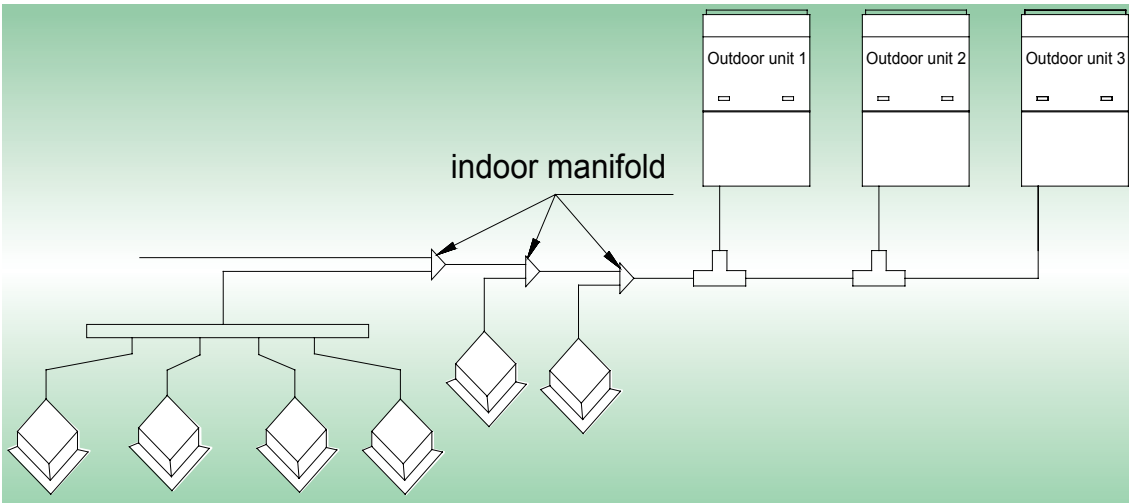
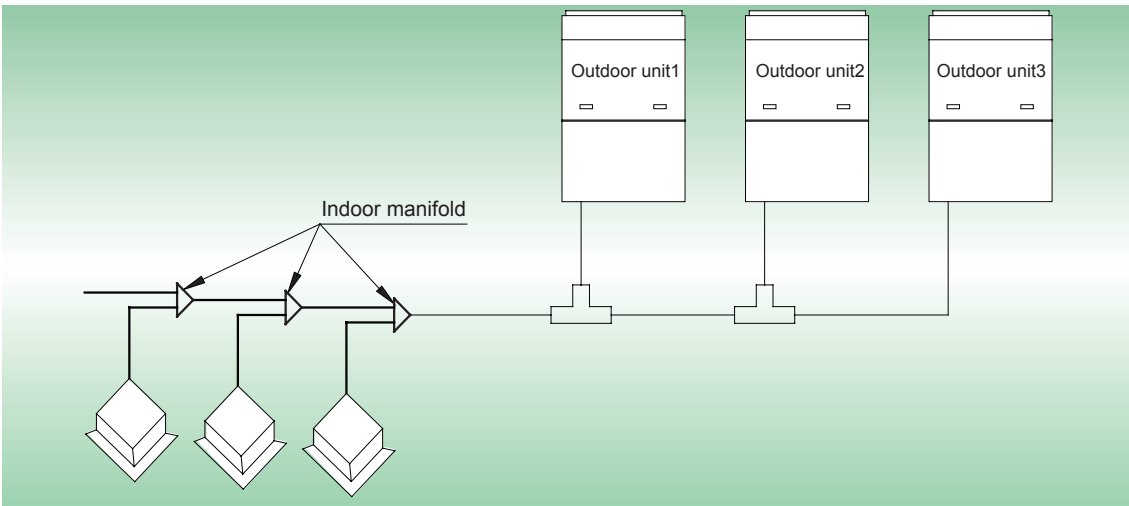

R410A Refrigerant System	Total capacity of downstream indoor unit(s) C (KBtu/h)	Model
Y-type Manifold	$C < 68$	FQ01A/A
	$68 \leq C \leq 102$	FQ01B/A
	$102 < C \leq 239$	FQ02/A
	$239 < C$	FQ03/A
T-type Manifold	$C \leq 136$	FQ14/H1
	$C \leq 232$	FQ18/H1
	$232 < C$	FQ18/H2

6) Fitting pipe between manifolds

Pipe size (between two manifolds at indoor unit side) is based on the total capacity of upstream indoor unit(s).

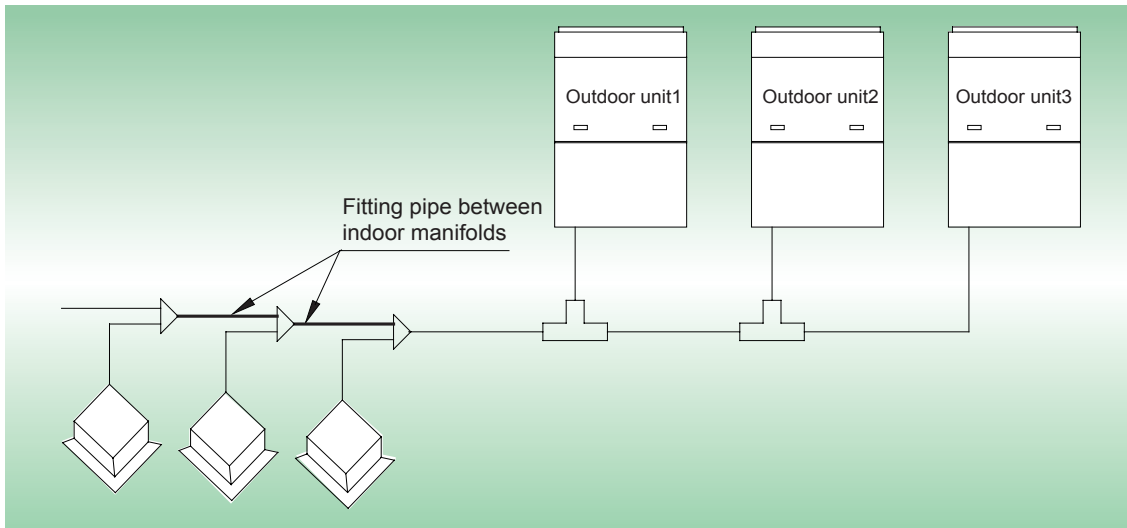

Total capacity of downstream indoor unit(s) C(Btu/h)	Dimension of the pipe of indoor branch	
	Gas Pipe mm(in.)	Liquid Pipe mm(in.)
$C \leq 17100$	$\Phi 12.7(1/2)$	$\Phi 6.35(1/4)$
$17100 < C \leq 48500$	$\Phi 15.9(5/8)$	$\Phi 9.52(3/8)$
$48500 < C \leq 72000$	$\Phi 19.05(3/4)$	$\Phi 9.52(3/8)$
$72000 < C \leq 96000$	$\Phi 22.2(7/8)$	$\Phi 9.52(3/8)$
$96000 < C \leq 144000$	$\Phi 28.6(1-1/8)$	$\Phi 12.7(1/2)$
$144000 < C \leq 216000$	$\Phi 28.6(1-1/8)$	$\Phi 15.9(5/8)$
$216000 < C \leq 240000$	$\Phi 34.9(1-3/8)$	$\Phi 15.9(5/8)$
$240000 < C \leq 336000$	$\Phi 34.9(1-3/8)$	$\Phi 19.05(3/4)$
$336000 < C$	$\Phi 41.3(1-5/8)$	$\Phi 19.05(3/4)$

7) Fitting pipe between indoor unit and manifold

Manifold should be matched with fitting pipe of indoor unit.

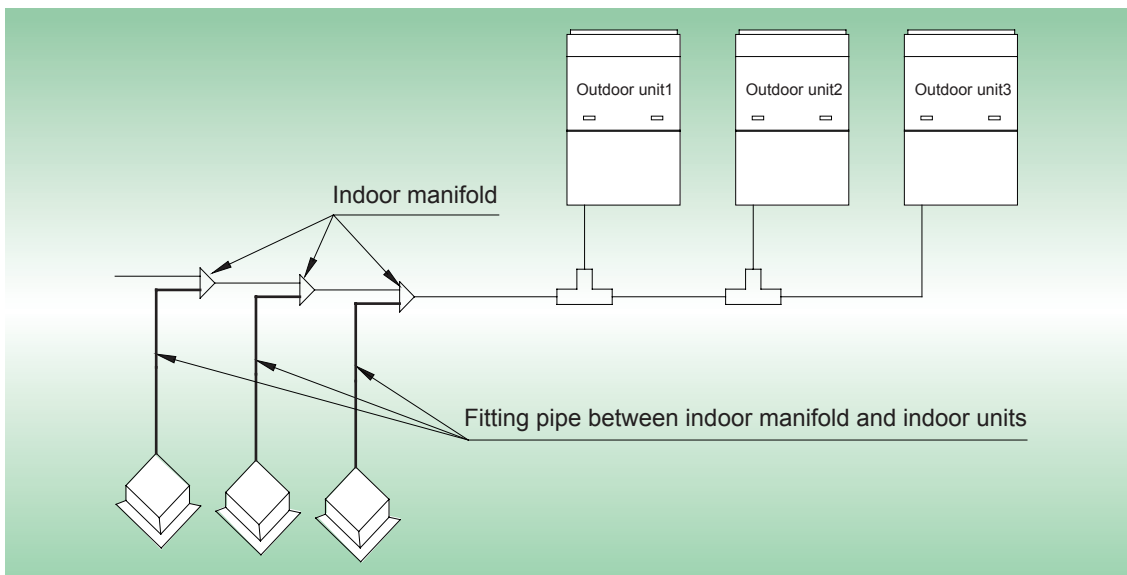

Rated capacity of indoor unit C(kBtu/h)	Pipe between in door branch and IDU	
	Gas Pipe mm(inch)	Liquid Pipe mm(inch)
$C \leq 9.5$	$\Phi 9.52(3/8)$	$\Phi 6.35(1/4)$
$9 < C \leq 14$	$\Phi 12.7(1/2)$	$\Phi 6.35(1/4)$
$14 < C \leq 48$	$\Phi 15.9(5/8)$	$\Phi 9.52(3/8)$
$48 < C \leq 72$	$\Phi 19.05(3/4)$	$\Phi 9.52(3/8)$
$72 < C \leq 96$	$\Phi 22.2(7/8)$	$\Phi 9.52(3/8)$

11 REQUIREMENTS FOR COMMUNICATION MODE

The GMV5 VRF unit air conditioning system adopts the CAN communication network. Manual dialling and differentiation of the communication cable polarity are not required for the indoor unit, and only functional dialling should be set for the indoor unit.

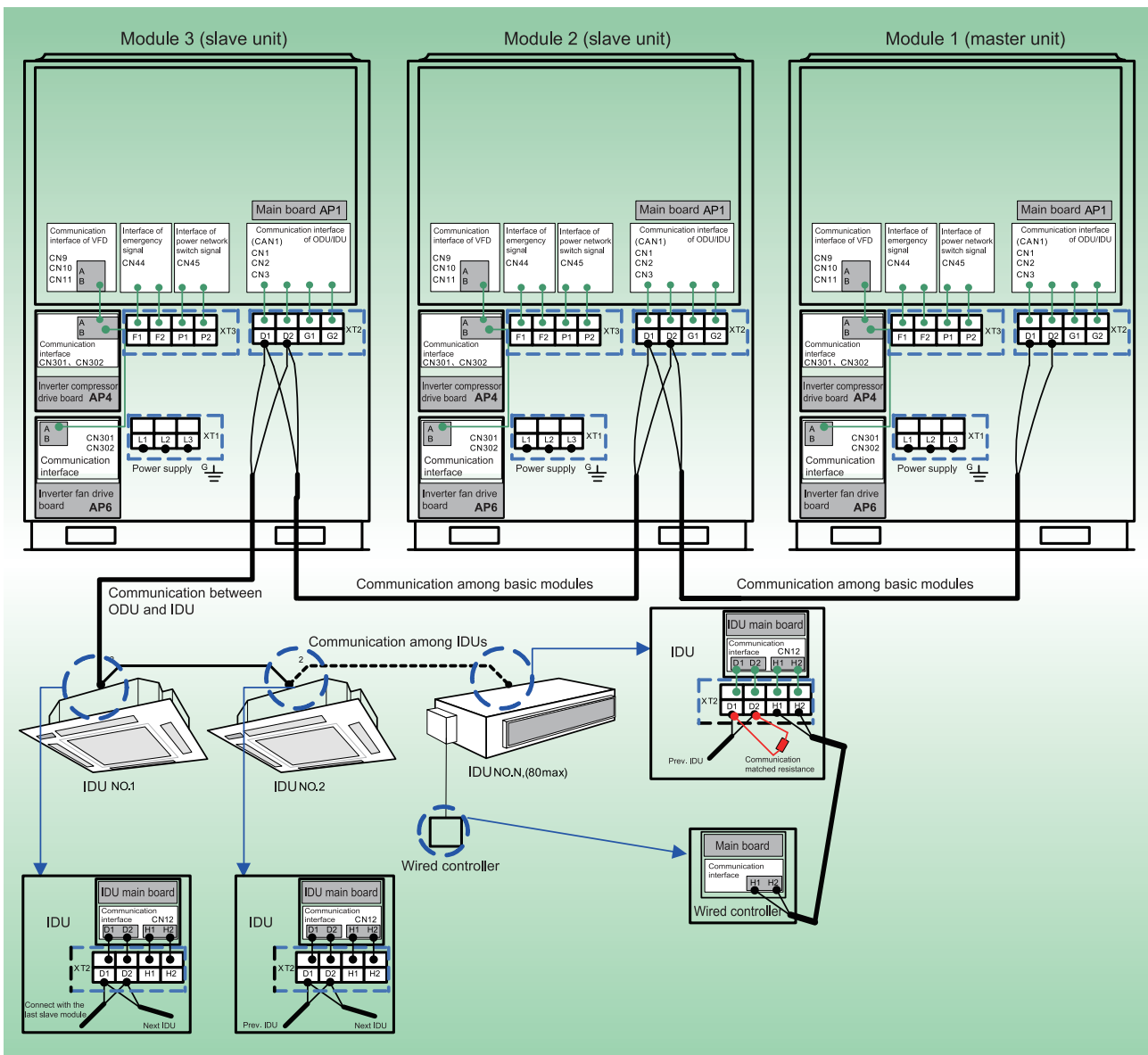

11.1 Connection Mode of Connection Line Terminals

All the communication connections of GMV5 are in the screw fastening mode.

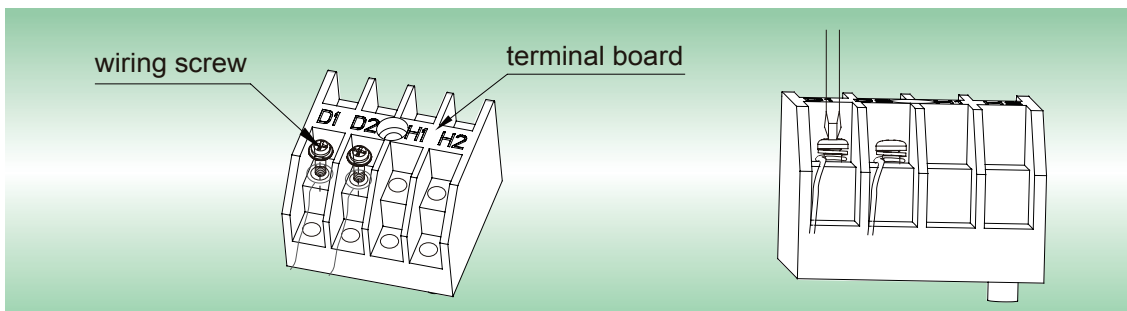

11.2 Communication Cable Material and Wring Mode

11.2.1 Communication Material

Module selection for the communication cables of outdoor unit and indoor unit.

Material Type	Total Length L(m) of Communication Cable between IDU Unit and IDU (ODU) Unit m(ft.)	Wire size	Remarks
Light/Ordinary polyvinyl chloride sheathed cord.	$L \leq 1000(3280-5/6)$	$\geq 2 \times \text{AWG}18$	1. If the wire diameter is enlarged to $2 \times \text{AWG}16$, the total communication length can reach 1500m (4921-1/4ft.). 2. The cord shall be Circular cord (the cores shall be twisted together). 3. If unit is installed in places with intense magnetic field or strong interference, it is necessary to use shielded wire.

Module selection for the communication cable between the indoor unit and wired controller.

Material type	Total length of communication line between IDU unit and wired controller L m(ft.)	Wire size	Remarks
Light/Ordinary polyvinyl chloride sheathed cord.	$L \leq 250(820-1/5)$	$2 \times \text{AWG}18 \sim 2 \times \text{AWG}16$	1. Total length of communication line can't exceed 250m (820-1/5ft.). 2. The cord shall be Circular cord (the cores shall be twisted together). 3. If unit is installed in places with intense magnetic field or strong interference, it is necessary to use shielded wire.

NOTICE: All of the selected communication wire must be consistent with local laws and regulations.

11.2.2 Communication Access Mode

The communication bus of GMV5 indoor and outdoor units must be connected in series, and star connection is forbidden. The indoor unit at the end of the communication bus for the indoor units and outdoor units must be connected to a communication matching resistor (which is contained in the packing bag of the outdoor unit).

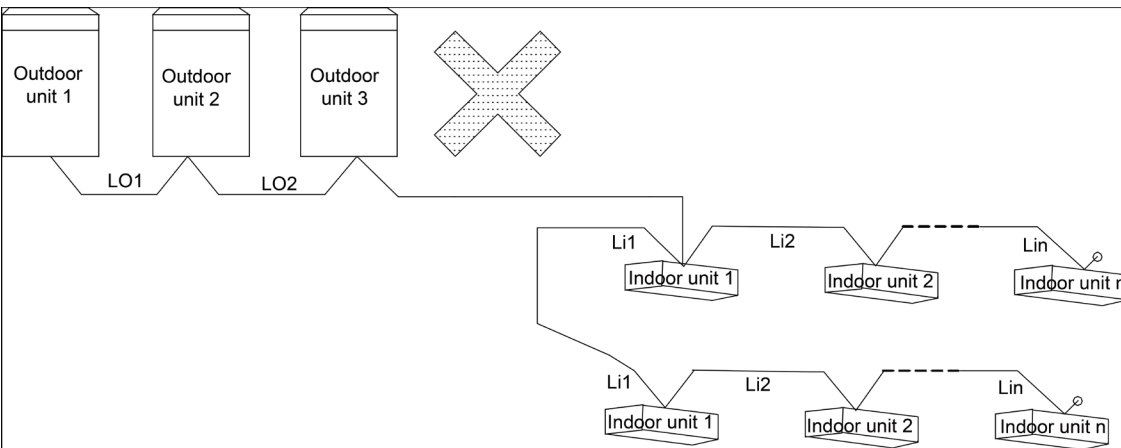
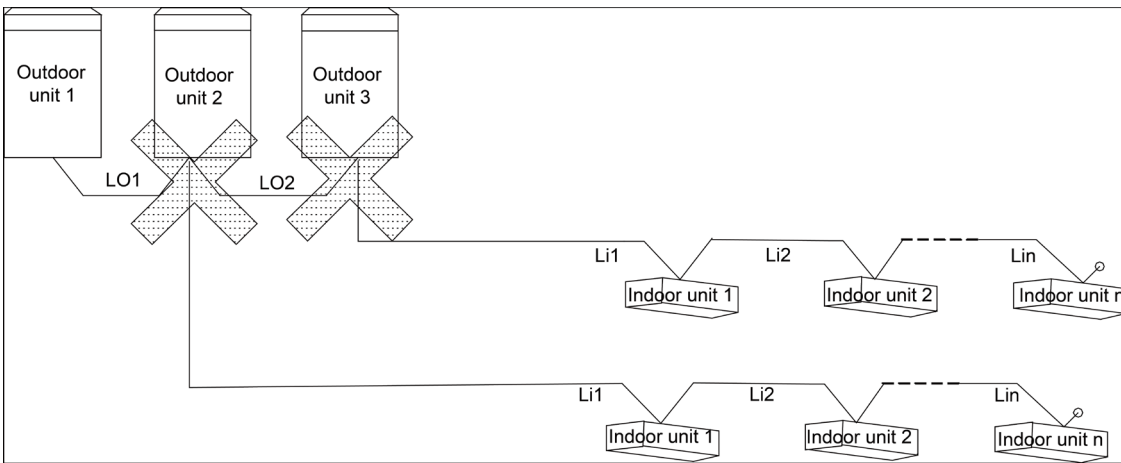
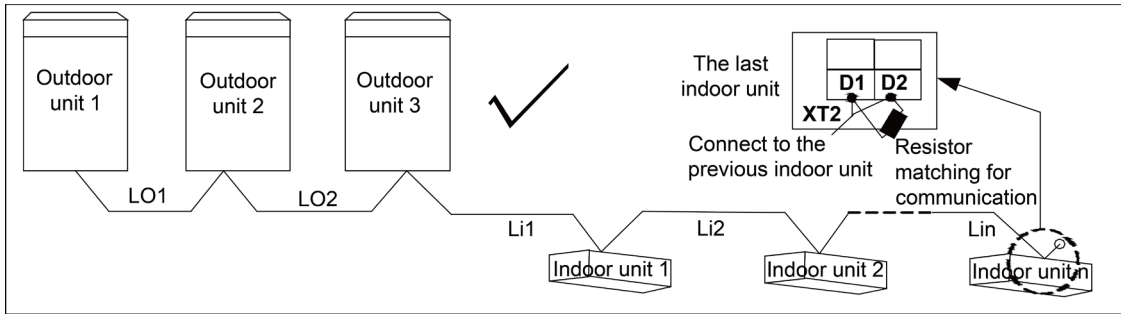

11.3 Connection Method and Procedure of Communication Cable

11.3.1 Communication connection between the indoor unit and outdoor unit

The indoor unit is connected to the outdoor unit through the D1/D2 port of the terminal plate XT2. The figures below show the connection method of the single outdoor unit and connection method of the modular outdoor unit.

Communication connection mode of the single module system

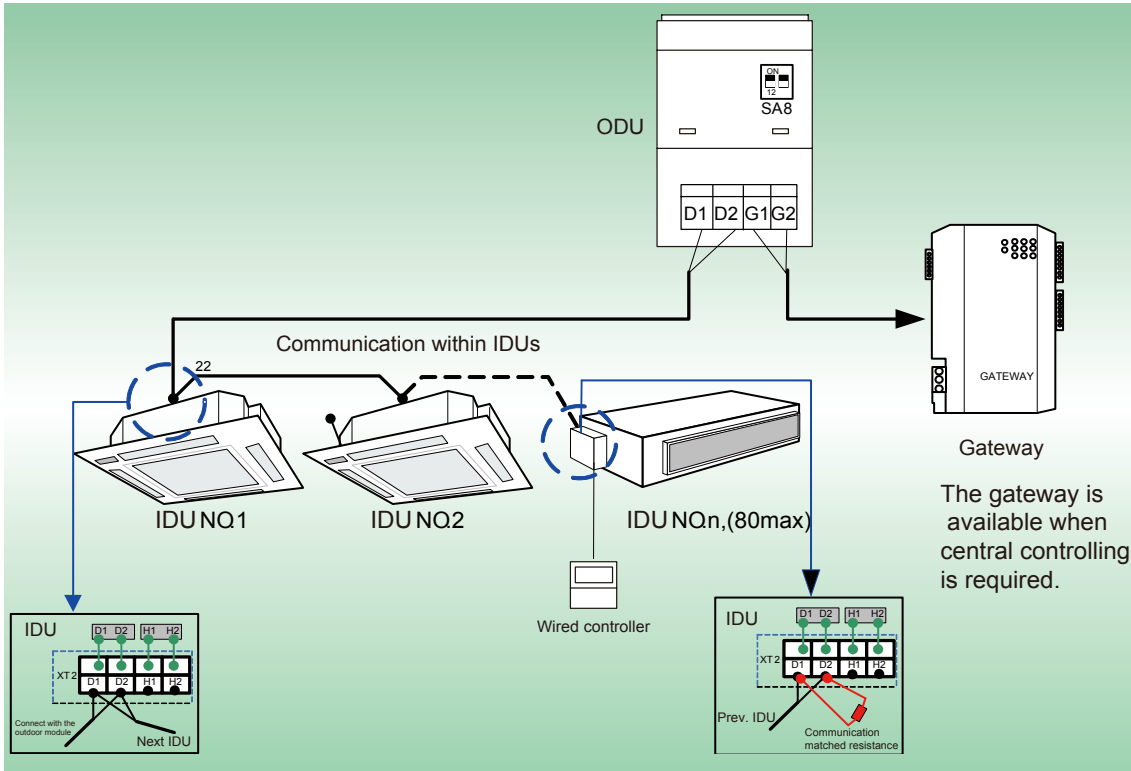

Communication connection mode of the multi-module system

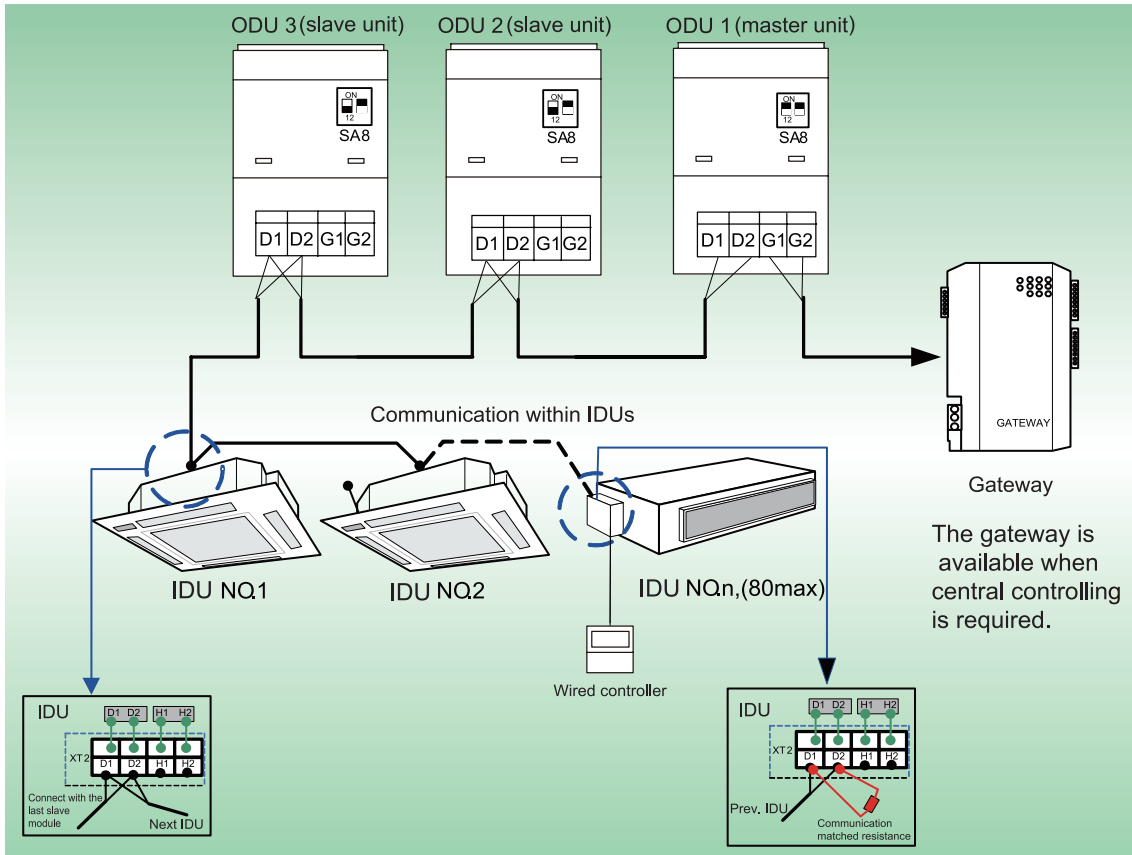

NOTICES:

- For the modular outdoor unit, if multiple outdoor unit modules are available, the master unit must be the first outdoor unit module on the communication line and cannot be connected to any indoor unit (the master unit is set by SA8 of the main board for outdoor unit).
- For the modular outdoor unit, if multiple outdoor unit modules are available, the indoor unit must be connected to the last slave module of outdoor unit (the slave unit is set by SA8 of the main board for outdoor unit).
- The communication cable must be wired separately from the power cable to avoid interference.
- A proper length of communication cable must be selected, and no joint is allowed.
- The indoor units must be connected in series, and the last indoor unit must be connected to a communication matching resistor (which is provided in the list of outdoor unit accessories).

11.3.2 Communication connection mode between the indoor unit and wired controller

The indoor unit and the wired controller are connected in one of the following four modes, which are respectively shown in Figure below:

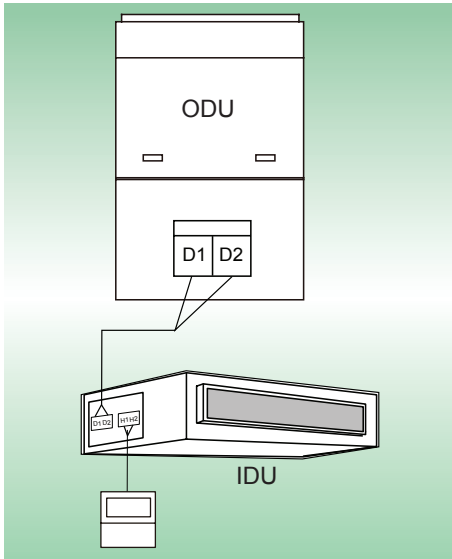

One wire controller controls one indoor unit

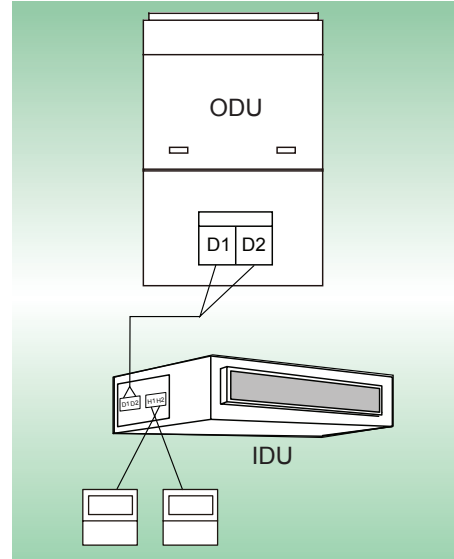

Two wire controllers control one indoor unit

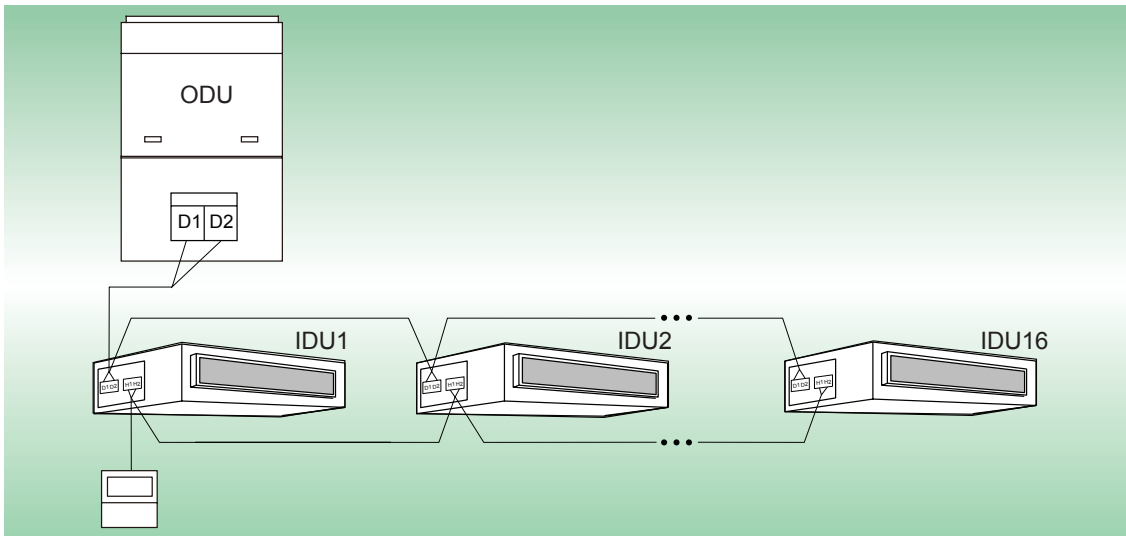

One wire controller controls multiple indoor units

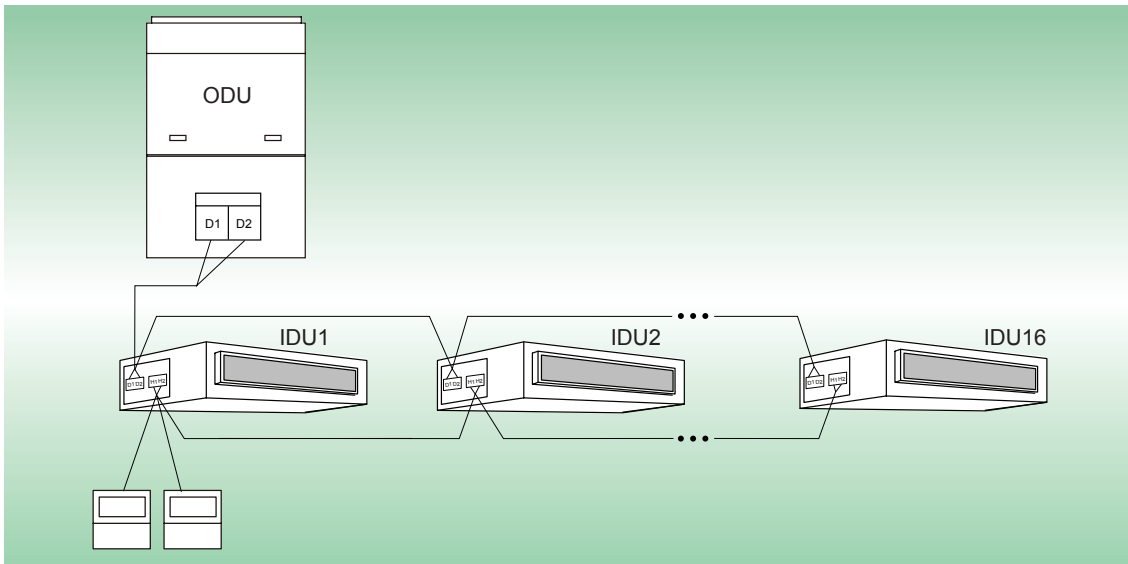

Two wire controllers control multiple indoor units

When two wired controllers control multiple indoor units at the same time, the wired controller can be connected to any indoor unit, the connected indoor units must belong to the same series, and only one wired controller must be set to a slave wired controller. The number of indoor units controlled by the wired controllers is not more than 16, and the connected indoor units must be on the same indoor unit network. The slave wired controller can be set in the power-on or power-off status:

- (1) Press and hold the "FUNCTION" button on the wired controller to be set to a slave wired controller for five seconds. The temperature area displays "C00". Continue holding the "FUNCTION" button for five seconds to enter the wired controller parameter setting interface. The temperature area displays "P00" by default.
- (2) Select a P13 parameter code by pressing "▲" or "▼". Press the "MODE" button to switch to parameter value settings. The parameter value blinks. Press "▲" or "▼" to select "02", and then press the "ENTER/CANCEL" button to complete settings.
- (3) Press the "ENTER/CANCEL" button to return to the upper-level menu till quitting parameter settings.

The user parameter setting list is as follows:

Parameter Code	Parameter Name	Parameter Range	Default Value	Remarks
P13	Wired controller address settings	01: master wired controller 02: slave wired controller	01	When two wired controllers simultaneously control one or more indoor units, the two wired controllers must use different addresses. The slave wired controller (address: 02) does not have the unit parameter setting function except its own address settings.

NOTICES:

- a. The default factory setting of all the wired controllers is the master wired controller status.
- b. In the parameter setting status, the "FAN", "Timer", "SLEEP", and "SWING" buttons are invalid. By pressing "ON/OFF", you can return to the main interface but will not power on/off the unit.
- c. In the parameter setting status, signals of the remote controller are invalid.

11.3.3 Connection mode between the air duct-type indoor unit and receiving LED panel

When the air duct-type indoor unit needs to be connected to a remote receiving LED panel, they are connected through DISP1 and DISP2 of the main board for indoor unit:

IDU type	Connection wire	Main board interface of corresponding IDU
Duct type IDU	Between boards (17-core)	DISP1 (direct to 8-core interface) DISP2 (direct to 9-core interface)

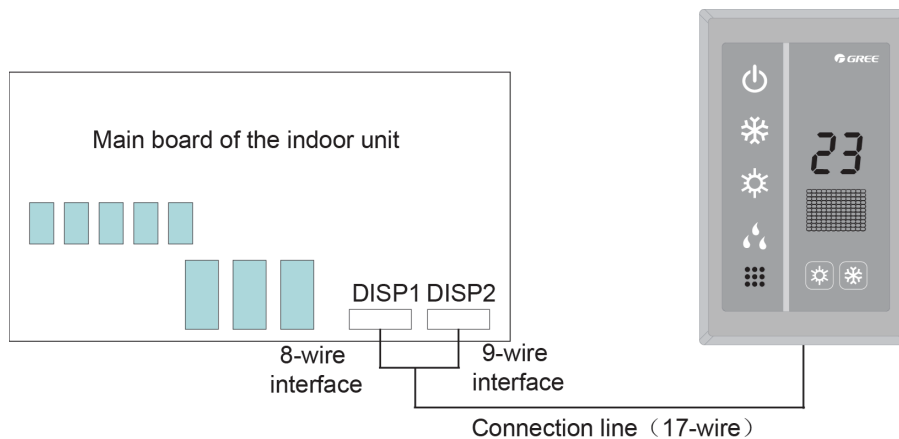

NOTES:

- a. The wired controller and remote receiving LED panel can be used at the same time.
- b. Note to select a remote controller when a remote receiving LED panel is used.

12 ELECTRICAL CONNECTION

12.1 External Connection Interfaces

External connection interfaces	Power supply	Quantity	4
		Label	L1 L2 L3 G
	Indoor/outdoor unit communication	Quantity	2
		Label	D1 D2
	Centralized control	Quantity	2
		Label	G1 G2

12.2 External Connection

Every unit should be equipped with a circuit breaker for short-circuit and overload protection. In general, circuit breaker is at OFF status.

During operation, all indoor units and outdoor units belonging to the same system must be kept energized status. Otherwise, the unit can't operate normally.

1) External connection diagram of a single unit

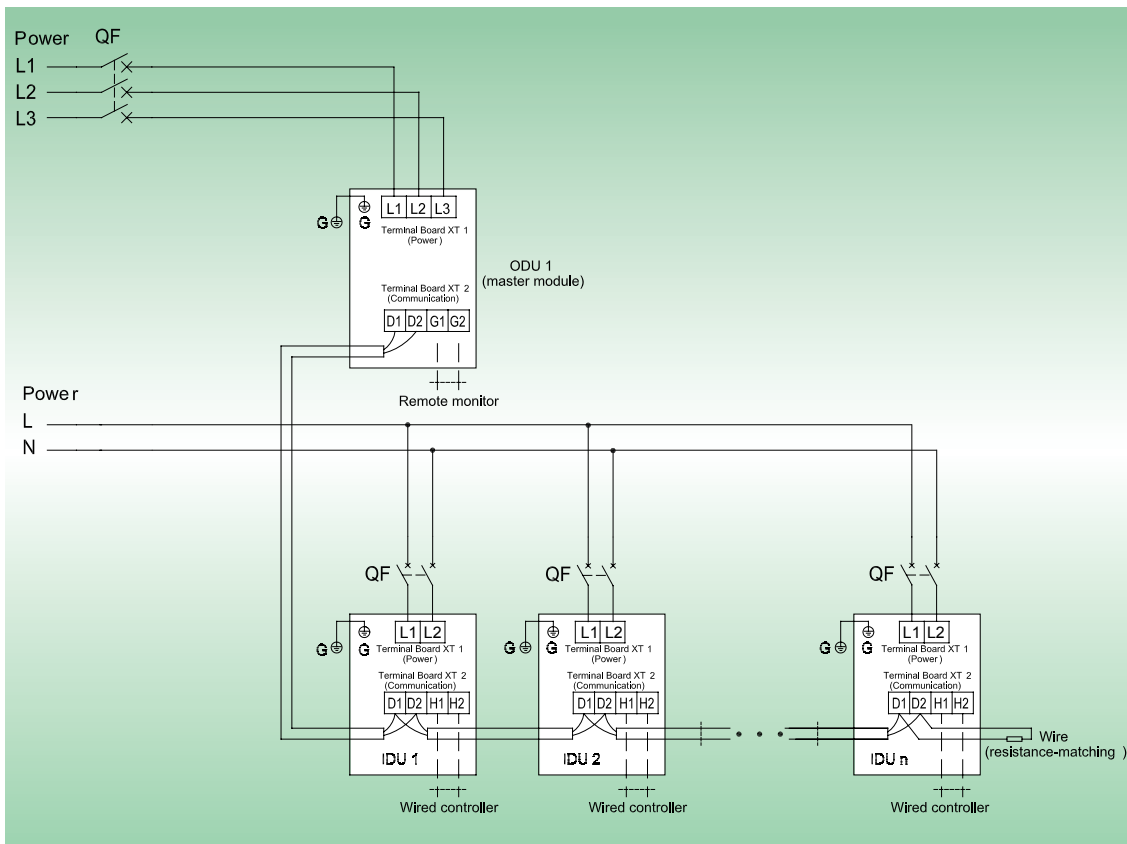

NOTICES:

The maximum number n of connected indoor units depends on the outdoor unit capacity. For details, see the content of the introduction to unit combination.

2) External connection diagram of modular connection

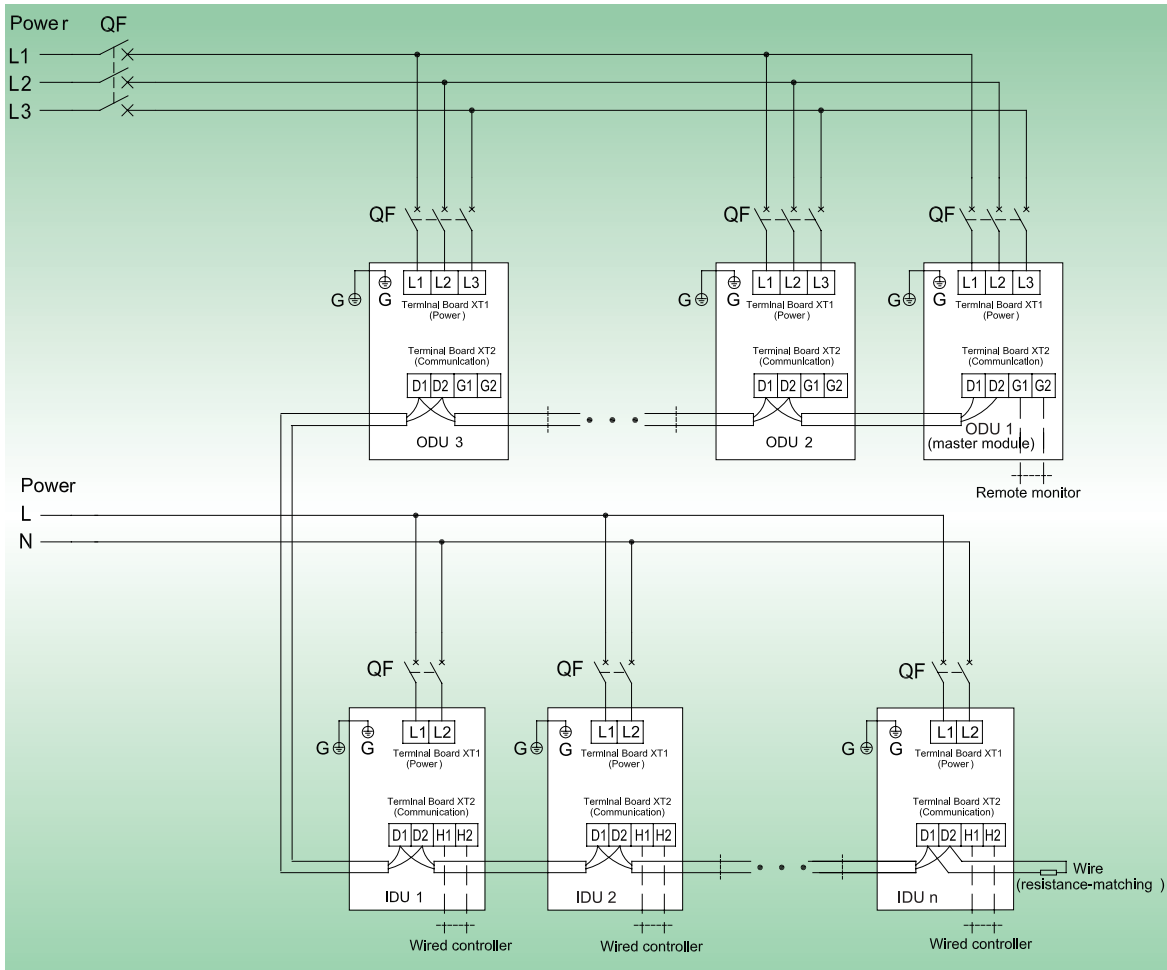

NOTICES:

- a. The maximum number N of connected outdoor units and the maximum number n of connected indoor units depend on the outdoor unit combination form.
- b. A copper conductor must be used as a power cable. It must comply with the relevant national lead standard and meet the current-carrying capacity requirement of the unit.

13 CALCULATION METHOD OF REFRIGERANT ADDED FOR ENGINEERING PIPING

Added refrigerant quantity R = Added refrigerant quantity A for piping + \sum Added refrigerant quantity B for each module

1) Added refrigerant quantity A for piping is calculated as follows:

Added refrigerant quantity A for piping

$$= \sum \text{Liquid pipe length} \times \text{Added refrigerant quantity for each meter (inch) of liquid pipe}$$

---	Diameter of liquid pipe (mm(inch))							
	28.6(1-1/8)	25.4(1)	22.2(7/8)	19.05(3/4)	15.9(5/8)	12.7(1/2)	9.52(3/8)	6.35(1/4)
kg/m	0.680	0.520	0.350	0.250	0.170	0.110	0.054	0.022
OZ/inch	0.61	0.47	0.31	0.22	0.15	0.10	0.05	0.02

2) \sum Added refrigerant quantity B for each module is calculated as follows:

Refrigerant charging amount B of every module kg(Pounds)		Rated Capacity(1000Btu/h)				
IDU/ODU rated capacity collocation ratio C	Quantity of included IDUs(N)	72	96	120	144	168
50% \leq C \leq 90%	N < 4	0	0	0	0	1.5(3.3)
	N \geq 4	0.5(1.1)	0.5(1.1)	0.5(1.1)	0.5(1.1)	3.5(7.7)
90% < C \leq 105%	N < 4	1(2.2)	1(2.2)	1.5(3.3)	1.5(3.3)	5.5(12.1)
	8 > N \geq 4	2(4.4)	2(4.4)	3(6.6)	3(6.6)	6.5(14.3)
	N \geq 8	4(8.8)	3.5(7.7)	4(8.8)	5.5(12.1)	8(17.6)
105% < C \leq 135%	N < 4	2(4.4)	2(4.4)	2.5(5.5)	3(6.6)	6.5(14.3)
	8 > N \geq 4	4(8.8)	3.5(7.7)	4(8.8)	4.5(9.9)	8(17.6)
	N \geq 8	4.5(9.9)	4.5(9.9)	5(11.0)	6(13.2)	9(19.8)

NOTICES:

- IDU/ODU rated capacity collocation ratio C = Sum of rated cooling capacity of indoor unit / Sum of rated cooling capacity of outdoor unit.
- If all of the indoor units are fresh air indoor units, the quantity of refrigerant added to each module is 0kg.
- If outdoor air processor is connected with normal VRF indoor unit, adopt the perfusion method for normal indoor unit for perfusion.

For example 1:

The OUD is composed of 3 modules: 72kBtu/h, 120 kBtu/h and 120 kBtu/h. The IDUs are made up of 7sets of 48 kBtu/h.

IDU/ODU rated capacity collocation ratio C = $48 \times 7 / (72 + 120 + 120) = 108\%$. The quantity of included IDUs is more than 4 sets. Please refer to the above table.

Refrigerant charging amount B for 72kBtu/h module is 4.0kg(8.8pounds).

Refrigerant charging amount B for 120 kBtu/h module is 4.0kg(8.8pounds).

Refrigerant charging amount B for 120 kBtu/h module is 4.0kg(8.8pounds).

$$\text{So, } \sum \text{Refrigerant charging amount B of every module} = 4.0 + 4.0 + 4.0 = 12\text{kg} (8.8 + 8.8 + 8.8 = 26.4\text{pounds}).$$

Suppose the Pipeline charging amount A = \sum Liquid pipe length \times refrigerant charging amount of every 1m (or 1in.) liquid pipe = 25kg (55.1 pounds)

$$\text{Total refrigerant charging amount R} = 25 + 12 = 37\text{kg} (55.1 + 26.4 = 81.5\text{pounds}).$$

For example 2:

Outdoor unit is a 72kbtu/h module and the indoor unit is a 72kbtu/h fresh air unit. The quantity (B) of refrigerant added to this module is 0kg (0pounds).

So, $\sum B$ (Quantity of refrigerant added to each module) = 0kg (0pounds).

Suppose that A (Quantity of refrigerant added to connection pipe) = \sum Length of liquid pipe x Quantity of refrigerant added to liquid pipe per meter = 5kg (11pounds).

R (Quantity of added refrigerant in total) = 5+0=5kg (11+0=11pounds).

Modular combination of outdoor unit subjects to combinations that is currently available.

After confirming that there is no leakage from the system, when the compressor is not in operation, charge additional R410A with specified amount to the unit through the filling opening of the liquid pipe valve of the outdoor unit. If required additional refrigerant cannot be quickly filled for increase of pressure in the pipe, set the unit at cooling startup and then fill the refrigerant from gas valve of outdoor unit. If ambient temperature is low, the unit can't be set to cooling mode but heating mode.

14 PRECAUTIONS ON REFRIGERANT LEAKAGE

(1) Personnel related to air conditioning engineering design and installation operators must abide by the safety requirement for preventing refrigerant leakage specified in local laws and regulations.

(2) The units adopt the R410A refrigerant, which is nonflammable and nontoxic. However, the space for refrigerant leakage must be sufficient to ensure that the refrigerant concentration does not exceed that specified in the safety requirement; otherwise, people involved can be stifled by the refrigerant. For example the maximum allowed concentration level of refrigerant to a humanly space for R410A according to the appropriate European Standard is limited to 0.44 kg/m³.

The maximum amount of refrigerant (kg) in the system = The volume of the room (m³) x The maximum allowed concentration level of refrigerant (kg/m³).

Total amount of refrigerant (kg) in the system = Total additional charging amount (kg) + Amount of refrigerant (kg) which is charged before leaving the factory (for the system consisting of multiple modules in parallel, the accumulative charge quantity of modules before leaving the factory is used)

Total amount of refrigerant (kg) in the system ≤ The maximum amount of refrigerant (kg) in the system

(3) When the total amount of refrigerant in the system is more than the maximum amount of refrigerant, the cooling system should be designed again. In this case, the cooling system can also be separated into several cooling systems with small capacity, or add corresponding ventilation measures or alarming display.

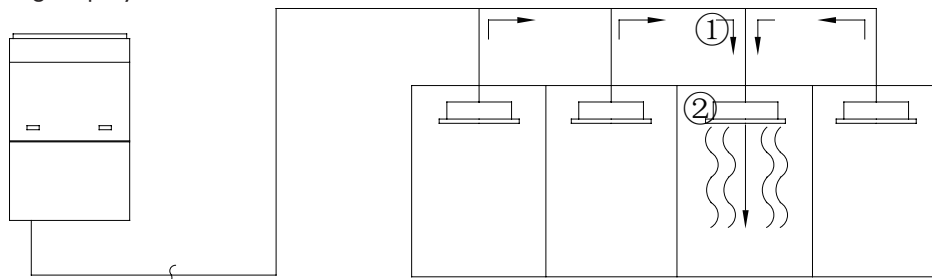

1) Flow direction of refrigerant leakage.

2) Room for refrigerant leakage. Since the concentration of refrigerant is greater than that of air, pay attention to the spaces where the refrigerant may residue, for example, the basement.

15 OPTIONAL COMPONENTS

The GMV5 series VRF units provide the following options:

		Model	Remarks
Manifold	Outdoor unit	ML01/A	For the model selection method, see the part of pipeline selection.
	Indoor unit	FQ01A/A, FQ01B/A, FQ02/A, FQ03/A, FQ04/A	
Remote receiving LED panel		JS05	Applicable to the air duct-type indoor unit
Remote controller		YAP1F	Duct-type indoor unit Optional (Wall-Mounted indoor unit Standard)
Remote controller for debugging		YV1L1	With the debugging function, used to set functions of the indoor unit
Classic wired controller		Wired controller XK46	Applicable to the air Cassette, Floor Ceiling, Wall-Mounted indoor unit Optional (duct-type indoor unit Standard)
Door controller		Wired controller XK79	With the access control function
Simple controller		Wired controller XK86	
Colour screen wired controller		Wired controller XK55	
Centralized controller		CE52-24/F(C)	
Smart zone controller		CE53-24/F(C)	
E-Smart Zone controller		CE54-24/F(C)	
Debugging software		DE40-33/A(C)	Applicable to the unit of CAN bus communication technology
Remote monitoring system	Software	FE30-24/DF(B)	Applicable to the unit of CAN bus communication technology
	Gateway	ME30-24/DF(B)	

Notice: If you need the above optional components, please consult your local sales company.

16 UNIT OPERATING RANGE

Cooling	-5°C(23°F)~52°C(125.6°F)
Heating	-20°C(-4°F) ~24°C (75.2°F)

When the indoor units are all VRF fresh air processor, the unit operating range is as follows:

Cooling	Ambient temperature: 16°C(60.8°F)~45°C(113°F)
Heating	Ambient temperature: -7°C (19.4°F)~16°C (60.8°F)

CAUTION:

Out of the working Temperature Range may damage this products and will invalidate the warranty.

Gree Electric Appliances, Inc. of Zhuhai, founded in 1991, is the world's largest air conditioner enterprise integrating R&D, manufacturing, marketing and services. Technology Innovation and quality are always our priority. With efforts of thousands of Gree's engineers, we own more than 3500 patents for our products. Nowadays, we have 7 production bases in Zhuhai, Chongqing, Hefei and Zhengzhou(China), as well as Brazil, Pakistan and Vietnam, with annual production capacity of 30 million sets of residential air conditioners and 4 million sets of commercial air conditioners.

With the installation of Gree commercial air conditioners in important projects at home and abroad like Media Village for 2008 Beijing Olympic Games, Stadiums for 2010 World Cup in South Africa, as well as India Telecom base station, Gree commercial air conditioners are ready to develop steadily to every corner in the world, to present a more comfortable and harmonious working environment and family atmosphere.



GREE MAKING BETTER AIR CONDITIONERS GREE MAKING BETTER AIR CONDITIONERS GREE MAKING BETTER AIR CONDITIONER GREE



Add: West Jinji Rd, Qianshan Zhuhai, Guangdong, China 519070

Tel: (+86-756)8614883 Fax: (+86-756)8614998

Http://www.gree.com Email: gree@gree.com.cn

For continuous improvement in the products, Gree reserves the right to modify the product specification and appearance in this manual without notice and without incurring and obligations.

■ SJ00440927