



Service Manual

GMV MTAC VRF for North America

(GC201909-II)

Capacity: 12kBtu/h

Rated Frequency: 60 Hz

CONTENTS

PRODUCT	2
1 Product List	2
2 Product Features	2
2.1 General Introduction.....	2
3 Specifications	3
3.1 Outdoor Unit.....	3
3.2 Operation Range.....	4
4 Product Capacity Correction	4
4.1 Instruction of Product Capacity Correction	4
4.2 Capacity Code	4
4.3 Capacity Correction Formula.....	4
5 Principal of Operation	6
CONTROL	8
1 Units' Control	8
1.1 Schematic Diagram of Units' Control.....	8
1.2 Operation Flow Chart	9
1.3 Unit Control Functions.....	10
2 Wired Controller	11
2.1 Control Panel	11
2.2 Installation and Removal	14
3 Remote Controller	17
4 Monitoring Software	19
4.1 Function Introduction.....	19
4.2 Connection of Computer and Units	19
4.3 Parts Introduction	20
4.4 Software Introduction	22
INSTALLATION	62
1 Engineering Installation Preparation and Notice	62
1.1 Installation Notice.....	62
1.2 Installation Key Points and Importance.....	62
2 Installation Materials Selection	63
2.1 Refrigerant Piping	64
2.2 Condensate Water Pipe	64
2.3 Insulation Material	64
2.4 Communication Cable and Control Cable	65
2.5 Power Cable	65

2.6 Hanger Rod and Support	65
3 Installation of Outdoor Unit	65
3.1 Check before Installation.....	65
3.2 Selection of Installation Site	65
3.3 Carrying and Installing Outdoor Unit.....	66
3.4 Installation Notices	66
3.5 Fixing and Damping of Unit	66
3.6 Outline Dimension and Position of Installation Hole	67
3.7 Installation Space Requirement.....	67
4 Installation of Electronic Expansion Valve Assy (unit with external EXV).....	68
5 Installation of Refrigerant Pipeline.....	68
5.1 Allowable Length and Height Difference of Connection Pipe	68
5.2 Dimension of Pipe (Main Pipe) from ODU to the 1 st Indoor Branch	69
5.3 Selection of Indoor Branches	69
5.4 Dimension of Pipe between Indoor Branches.....	70
5.5 Dimension of Pipe between Indoor Branch and IDU.....	70
6 Installation of Connection Pipe	71
6.1 Flaring Process	71
6.2 Vacuum Pumping, Refrigerant Adding.....	75
7 Electric Wiring	76
7.1 Wiring Diagram	77
7.2 Power Cable Wire Gauge and Circuit Breaker Selection	78
8 Debugging of Unit	78
8.1 Preparation for Debugging	78
8.2 Debugging of Unit	79
8.3 Parameters Reference Value for the Normal Operation of Unit	82
MAINTENANCE	85
1 Malfunction List.....	85
1.1 Malfunction List for the Wired Controller.....	85
1.2 Status Display Table for Indicators on Main Board of Outdoor Unit.....	85
2 Troubleshooting	88
3 Power Distribution of Unit	98
3.1 Power Distribution of Unit.....	98
3.2 Main Electric Parts	98
3.3 Circuit Diagram	99
4 Removal of Parts	99
4.1 Key Parts	99

4.2 Removal of Key Parts	100
5 Common Maintenance	108
5.1 Vacuum Drying for the System	108
5.2 Fill and Charge Refrigerant	109
5.3 Airtightness Test.....	109
6 Exploded View of Unit and Parts' List.....	111

PRODUCT

PRODUCT

1 Product List

Model	Product Code	Cooling Capacity	Heating Capacity	Power Supply	Refrigerant	Appearance
		kW(Btu/h)	kW(Btu/h)			
GMV-12WP/A-T(U)	CN850W0930	3.52 (12000)	3.52 (12000)	208V/230V~ 60Hz	R410A	

2 Product Features

2.1 General Introduction

GMV MTAC is a kind of concealed VRF unit, which adopts front side air discharge and air return. It's mainly developed for North American market, which is applicable for apartments, offices, hotels and other areas. The unit adopts deep subcooling technology for ensuring the quiet cooling operation. Moreover, the unique drainage control technology has solved the problem of water drainage of outdoor unit under low-temperature environment. Include GMV-12WP/A-T(U).

2.1.1 Features

- (1) Super high energy efficiency.

The system adopts all DC motor, which greatly improves efficiency. The energy efficiency for Gree all DC unit is increased greatly. SEER of GMV-12WP/A-T(U) is up to 15.5; HSPF of GMV-12WP/A-T(U) is up to 9.5.

- (2) New generation CAN bus communication.

Due to the latest communication method—CAN Bus Communication, system's anti-interference capability is stronger and the control on indoor units is more accurate, with higher reliability. Specialized shield wire is no more needed and ordinary communication wire can be applied in the construction, which has increased the installation flexibility.

- (3) Long connection pipe.

GMV-12WP/A-T(U):

The maximum length of connection pipe is 30m(98-3/8ft) (in total) and the farthest connection pipe between indoor and outdoor units can be 30(98-3/8ft) m's long, which has extended the installation condition and reduced the limit of installation distance.

- (4) Wide operation range.

Units can operate reliably in a wide temperature range (cooling: -5~48°C(23~118.4°F), heating: -20~27°C(-4~80.6°F)).

- (5) Fine sound quality.

Through a series of optimized measures, system has reduced the throttle noise and oil return noise of indoor units, gas bypass noise, etc. so that units are more comfortable regarding sound quality.

(6) Intelligent PID capacity regulation.

With the independently developed PID capacity regulation technology, units are able to control the indoor ambient temperature more quickly and reduce the fluctuation of room temperature.

(7) Complete protection.

Units are equipped with a series of protection to accurately identify errors and protect the units, which has ensured reliable and safe operation.

3 Specifications

3.1 Outdoor Unit

Model			GMV-12WP/A-T(U)
Cooling capacity	kW		3.52
	Btu/h		12000
Heating capacity	kW		3.52
	Btu/h		12000
Circulating air volume	m ³ /h		850
	CFM		500
Noise	dB(A)		Indoor46/Outdoor57
Refrigerant charge volume	Kg		0.8
	oz		28.2
Power supply			208V/230V~60Hz
Rated power input	Cooling	kW	1.4
	Heating	kW	1.1
Unit Dimensions (W×D×H)	mm		1069×500×406
	inch		42-1/16×19-11/16×16
Dimensions (W×D×H)	mm		1164×601×470
	inch		45-13/16×23-11/16×18-8/16
Compressor			SNB150FGAMC
Water-proof level			IPX4
Suitable climate			T1
Connection pipe	Gas	mm	Φ12.7
		inch	Φ1/2
	Liquid	mm	Φ6.35
		inch	Φ1/4
	Connection Method		
Net weight	Kg		55
	oz		121

NOTICE!

- ① Units conform to design standard: ARI 210/240.
- ② Specifications may be changed due to product improvement. Please refer to nameplates of the units.
- ③ Noise data are collected from a semi-anechoic room. Decibels may be slightly higher in actual operation due to environmental change.
- ④ Refrigerant charge volume listed in the table is based on the condition where indoor and

outdoor units are at a same level and with no connection pipe. Supplementary refrigerant needs to be charged according to actual circumstance.

3.2 Operation Range

Cooling	Outdoor temperature: -5~48°C (23~118.4°F)
Heating	Outdoor temperature: -20~27°C (-4~80.6°F)

4 Product Capacity Correction

4.1 Instruction of Product Capacity Correction

Nominal cooling capacity and nominal heating capacity are tested under given conditions:

- (1) Rated cooling or heating condition.
- (2) No height difference between indoor unit and outdoor unit.
- (3) Short connection pipe.

If the three conditions above have changed, the cooling and heating capacity will change correspondingly and correction is needed.

4.2 Capacity Code

Instruction of capacity code.

GMV-12WP/A-T(U) are identical in components, systems and structure, etc. While the required capacity is set through the capacity DIP switch.

Sheet of DIP Switch (5-bit DIP switch)					
Model	Bit 1	Bit 2	Bit 3	Bit 4	Bit 5
GMV-12WP/A-T(U)	0	1	1	1	0

4.3 Capacity Correction Formula

4.3.1 Rated Capacity of Outdoor Unit

Model		GMV-12WP/A-T(U)
Rated cooling capacity	kW	3.52
	Btu/h	12000
Rated heating capacity	kW	3.52
	Btu/h	12000

4.3.2 Correction Factor of Indoor and Outdoor Temperature

(1) Correction factor of cooling capacity.

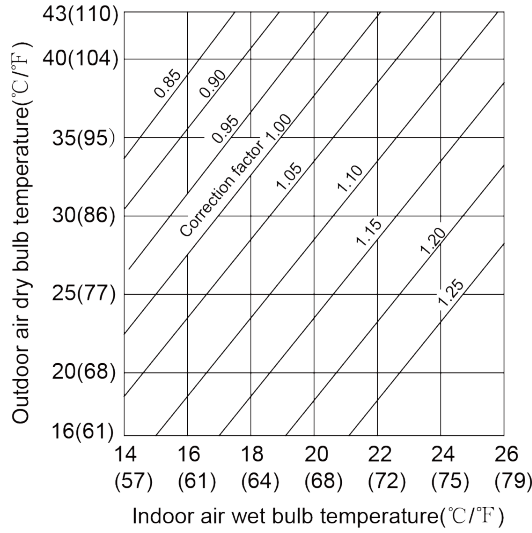

(2) Correction factor of heating capacity.

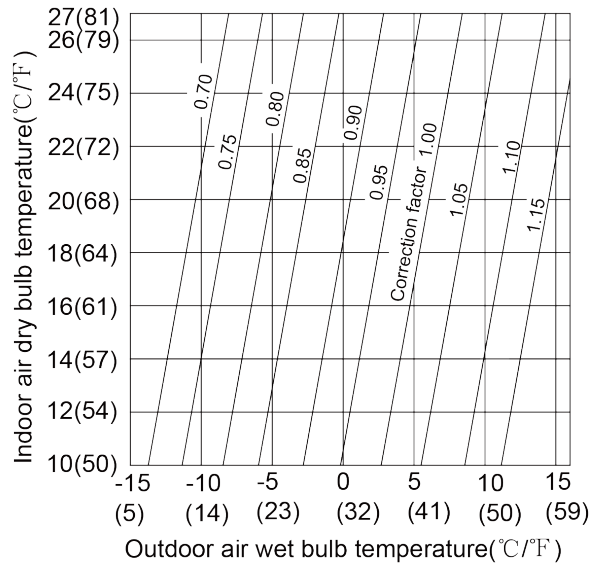

4.3.3 Correction Factor of Pipe Length and Height Difference

Symbol description:

Hp: Height difference in case indoor unit is below outdoor unit(m/feet).

Hm: Height difference in case indoor unit is above outdoor unit (m/feet).

L: Length of one-way equivalent pipe.

Below table shows the capacity variance ratio for 100% full load in standard working condition (thermostat setting is 16°C (61°F) for cooling and 30°C (86°F) for heating).

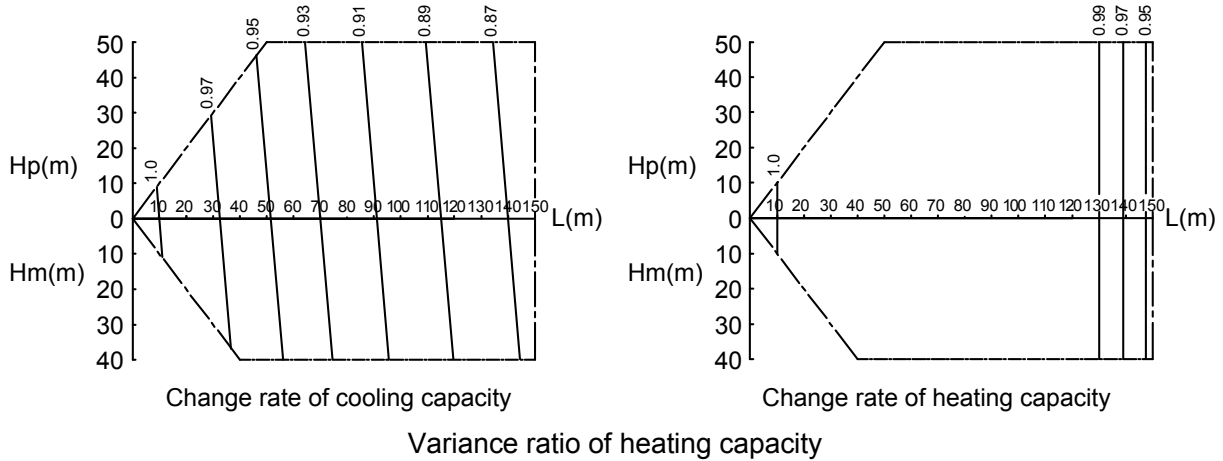

NOTICE!

m	0	10	20	30	40	50	60	70	80	90	100	110	120	130	140	150
ft	0	33	66	98	131	164	197	230	262	295	328	361	394	427	459	492

5 Principal of Operation

Components in flowcharts are presented according to the following table:

Name	Compressor	4-way valve	Cut-off valve	One-way valve	Capillary tube
Symbol					
Name	Gas-liquid separator	Pressure switch	Pressure sensor	Axial-flow finned heat exchanger	Electronic expansion valve
Symbol					

In cooling, the low-temperature and low-pressure refrigerant gas from each indoor heat exchanger will be merged and inhaled by the compressor and then become high-temperature and high-pressure gas, which will later be discharged into outdoor heat exchangers. By exchanging heat with outdoor air, refrigerant will turn to liquid and flow to each indoor unit via Y-type branch or manifold. Pressure and temperature of the refrigerant will then be lowered by throttle elements before it flows into indoor heat exchangers. After exchanging heat with indoor air, refrigerant will become low-temperature and low-pressure gas again and repeat the circulation so as to realize the cooling effect. In heating, 4-way valve will be energized to make refrigerant circulate in a reverse direction of cooling. Refrigerant will release heat in indoor heat exchangers (electric heating elements will also work under certain circumstance and release heat) and absorb heat in outdoor heat exchangers circularly so as to realize the heating effect.

CONTROL

CONTROL

1 Units' Control

1.1 Schematic Diagram of Units' Control

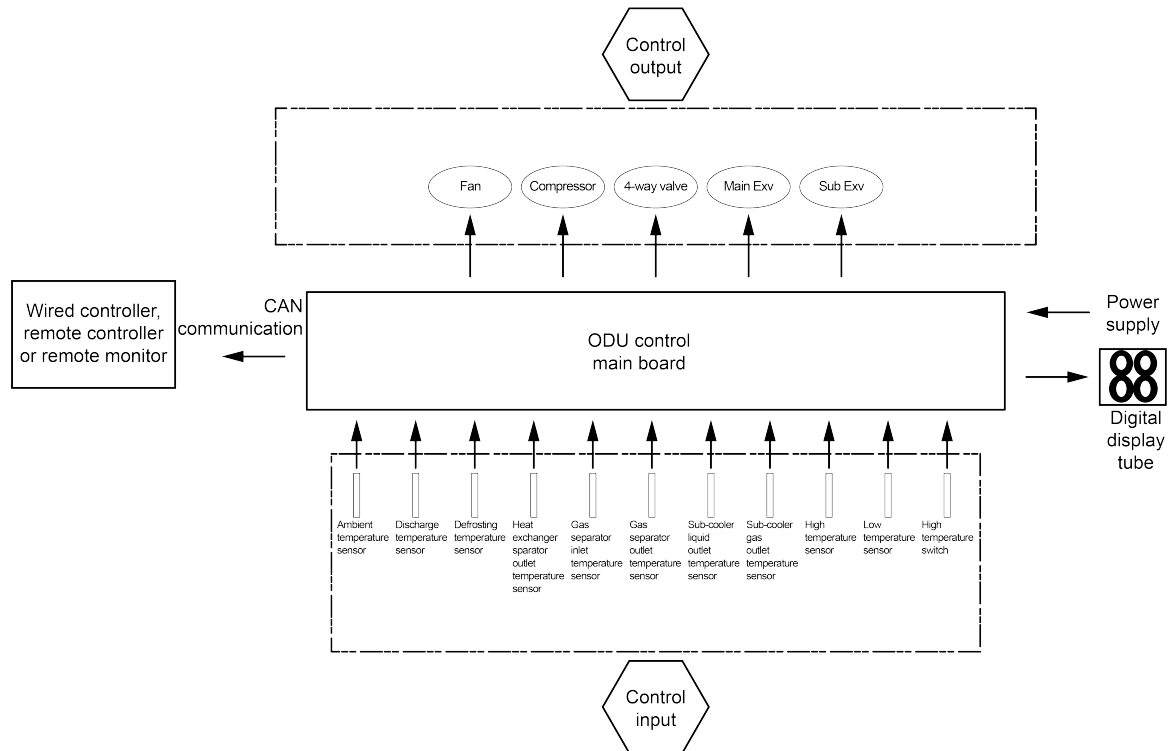

(1) Interpretation on the schematic diagram

- 1) High pressure switch is used to identify system's high and low pressure. When pressure is too high, the switch will break off and send a signal to main board. Main board will pass this signal to controller, where the error will be displayed, and stop unit from working.
- 2) High/low pressure sensor is used to test unit's high/low pressure and send real-time data to controller, which will control each unit's output according to the control logic.
- 3) Temperature sensors are used to test the tube temperature of the unit and send data to the controller, which will control each unit's output according to the control logic.

1.2 Operation Flow Chart

1.2.1 Operation Flow Chart of Indoor Unit

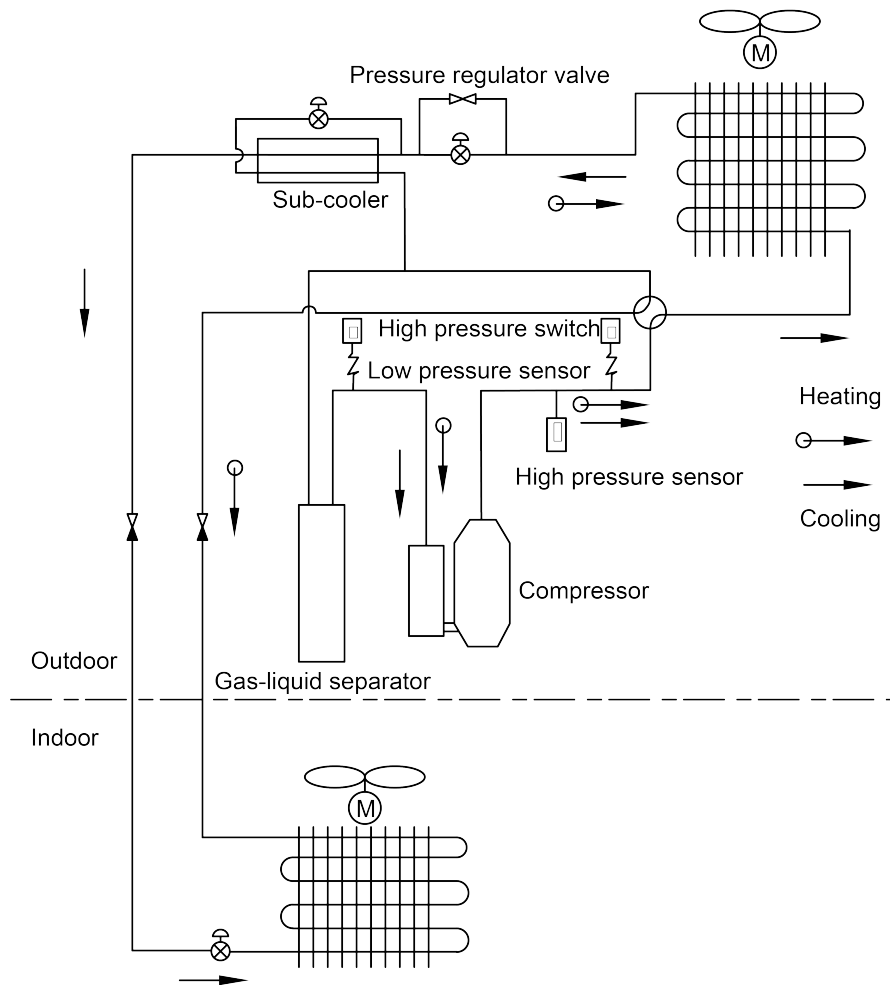

- (1) Cooling operation.
- (2) Heating operation.
- (3) Drying operation.
- (4) Operation procedure is the same as that of cooling operation.
- (5) Fan operation.
- (6) The EXV of the indoor unit closes in fan mode, so that there is no refrigerant flow in the refrigerant pipe of that indoor unit. But the fan of that indoor unit operates.

1.2.2 Operation Flow Chart of Outdoor Unit

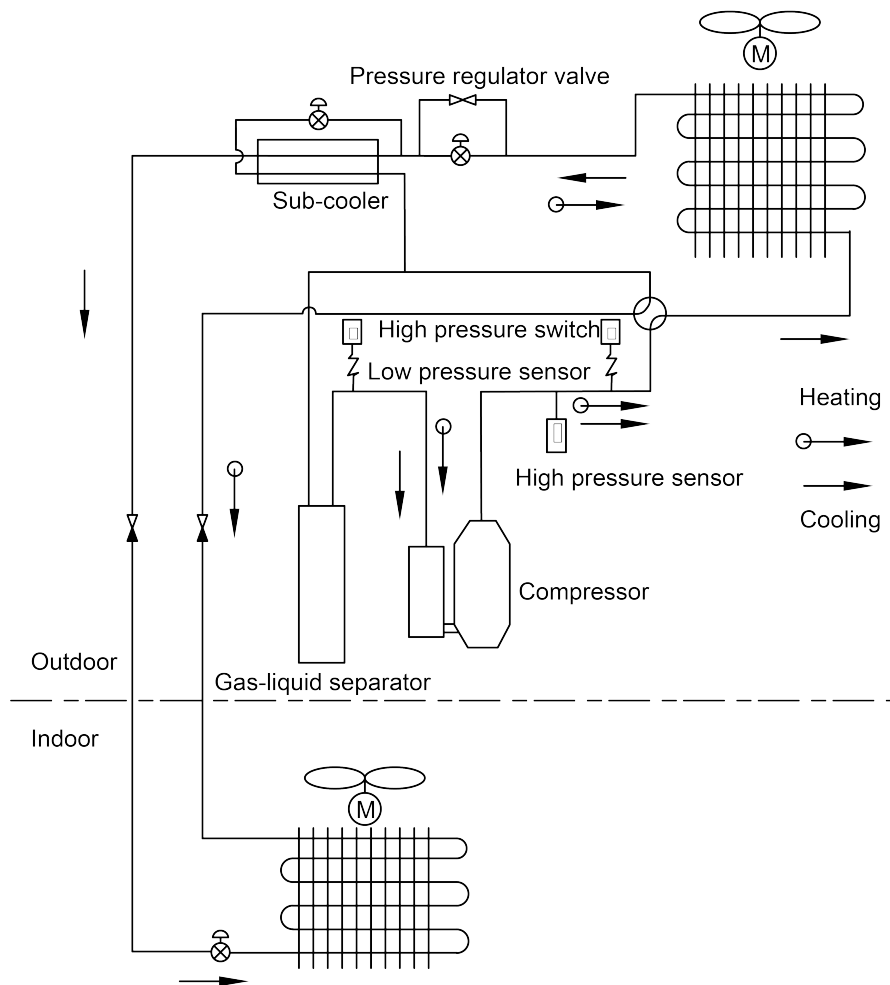

- (1) Cooling operation.
- (2) Heating operation.

1.3 Unit Control Functions

1.3.1 Control Functions of Outdoor Unit

- (1) Include the following contents.
- (2) Compressor capacity output.
- (3) Compressor start-up control.
- (4) Outdoor fan control.
- (5) Defrosting control.
- (6) Heating EXV control.
- (7) Subcooling valve control.
- (8) Refrigerant lacking control.

1.3.2 Control Functions of Indoor Unit

- (1) Include the following contents.
- (2) Cool.
- (3) Dry.







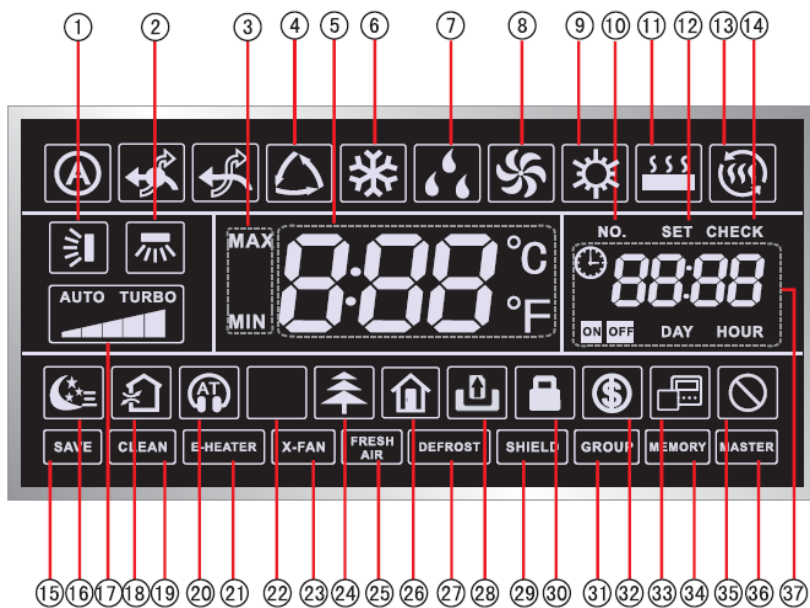













- (4) Heat.
- (5) Fan.
- (6) Heating temperature compensation.
- (7) Anti-freezing.
- (8) Air swing.
- (9) Drainage pump.
- (10) IDU EXV.
- (11) Static pressure level.



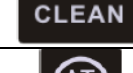









2 Wired Controller

2.1 Control Panel

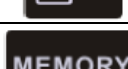

NO.	Symbols	Instructions
1		Up and down swing function

NO.	Symbols	Instructions
2	 *	Left and right swing function
3		It's valid under Save mode and displays during setting process Temperature lower limit for Cooling: Limit the minimum temperature value under Cooling or Dry mode Temperature upper limit for Heating: Limit the maximum temperature value under Heating, Space Heating or 3D Heating mode
4	 *	Auto mode (Under Auto mode, the indoor units will automatically select their operating mode as per the temperature change so as to make the ambient comfortable)
5		It shows the setting temperature value (In case the wired controller is controlling a Fresh Air Indoor Unit, then the temperature zone will display FAP)
6		Cooling mode
7		Dry mode
8		Fan mode
9		Heating mode
10		When inquiring or setting project number of indoor unit, it displays "NO." icon
11	 *	Floor Heating mode (When Heating and Floor Heating simultaneously shows up, it indicates 3D Heating is activated)
12		Display "SET" icon under parameter setting interface
13	 *	Space Heating mode
14		Display "CHECK" icon under parameter view interface
15		Outdoor unit operates under Save mode/upper limit of system capacitor less 100%/remote Save status
16		Sleep status
17		Current set fan speed (including auto, low speed, medium-low speed, medium speed, medium-high speed, high speed and turbo seven status)
18	 *	Air status, Indoor unit optional function
19		Remind to clean the filter
20		Quiet status (including Quiet and Auto Quiet two status)
21	 *	Allow auxiliary electric heating On icon
22		Light On/Off function
23		X-fan function

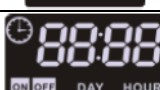
NO.	Symbols	Instructions
24	 *	Health function, Indoor unit optional function
25	 *	Reserved function
26		Out function
27		Outdoor unit defrosting status
28		Gate-control function
29		Shielding status
30		Child Lock status
31		One wired controller controls multiple indoor units
32		Save status of indoor unit
33		It indicates the current wired controller is the slave wired controller (address of wired controller is 02)
34		Memory status (The indoor unit resumes the original setting state after power failure and then power recovery)
35		Invalid operation
36		Current wired controller connects master indoor unit
37		Timer zone: Display system clock and timer status

NOTICE! When wired controller is connected with different indoor units, some functions will be different

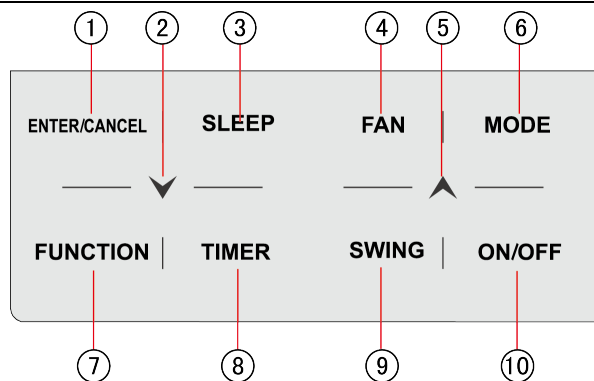

Button Graphics

2.2 Installation and Removal

2.2.1 Installation Dimensions

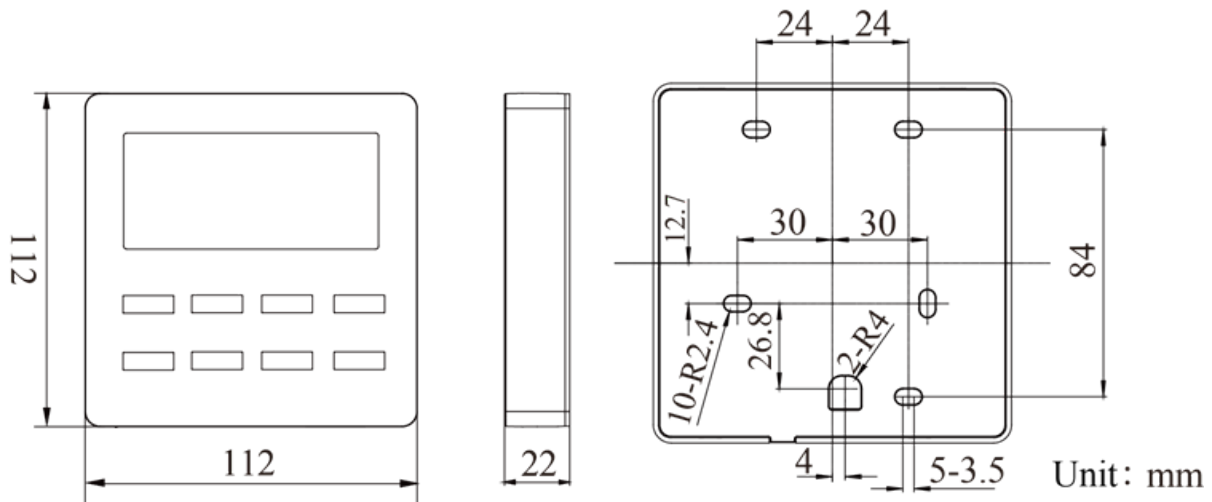

mm	112	22	2.4	3.5	4	5	12.7	24	26.8	30	84
inch	4.41	0.87	0.09	0.14	0.16	0.20	0.50	0.94	1.06	1.18	3.31

2.2.2 Installation Method

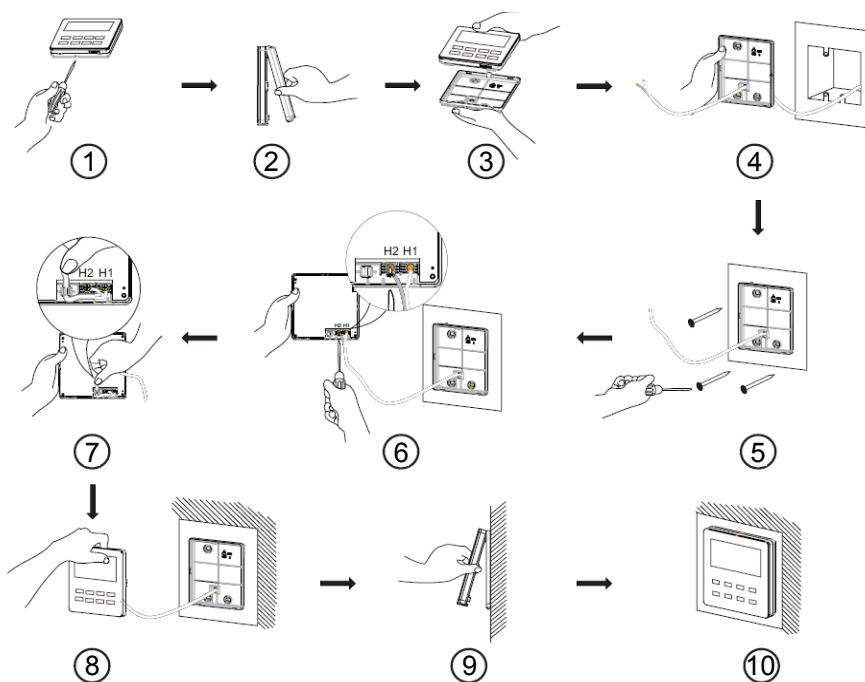

Above is the simple installation process of wired controller; please pay attention to the following items:

- (1) Before installation, please cut off the power for indoor unit.
- (2) Pull out the two-core twisted pair from the installation hole on wall, and then pull this wire through the "□" shape hole at the rear side of Soleplate of wired controller.
- (3) Stick the bottom plate of wired controller on the wall and then use Self-tapping Screw ST3.9×25 MA or Screw M4×25 to fix Soleplate and installation hole on wall together.
- (4) Connect two-core twisted pair to H1 and H2 wiring column and then fix the screws.

- (5) Tidy up the lines in slot on the back of the panel, and then bundle the front panel of wired controller to its soleplate and the installation is completed.

NOTICE! If the wire size of the selected communication line is too large, you can peel some sheath layer of communication wire to satisfy installation requirements.

⚠ WARNING

If caliber of the communication cord is too large, which causes difficulty in leading or sticking the cord according to above point 2 and point 5, strip some of the sheath of the communication cable to meet the installation requirement.

2.2.3 Removal Method

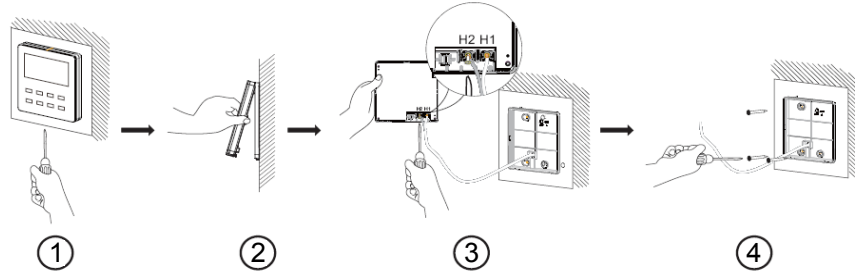

2.2.4 Connection of Communication Cord

There are 4 ways to connect wired controller with indoor units' network:

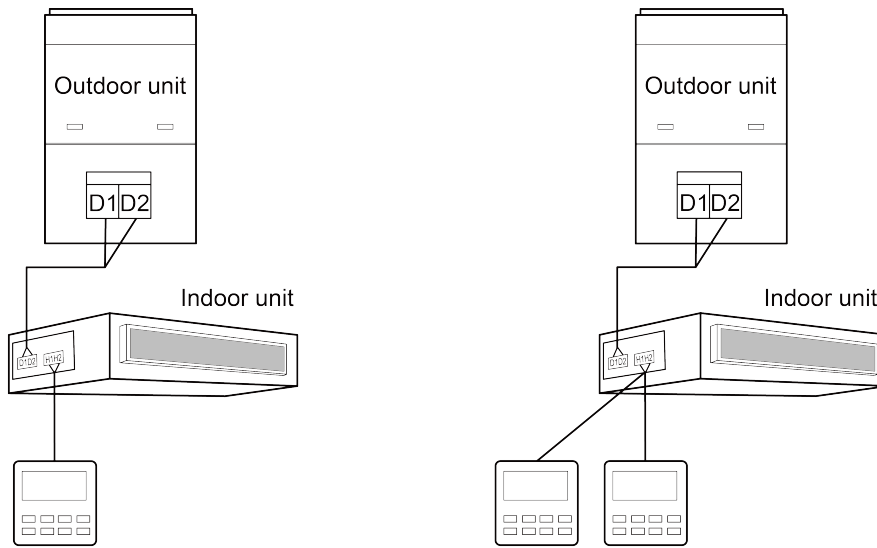

One wired controller control one indoor unit

Two wired controllers controls one indoor unit

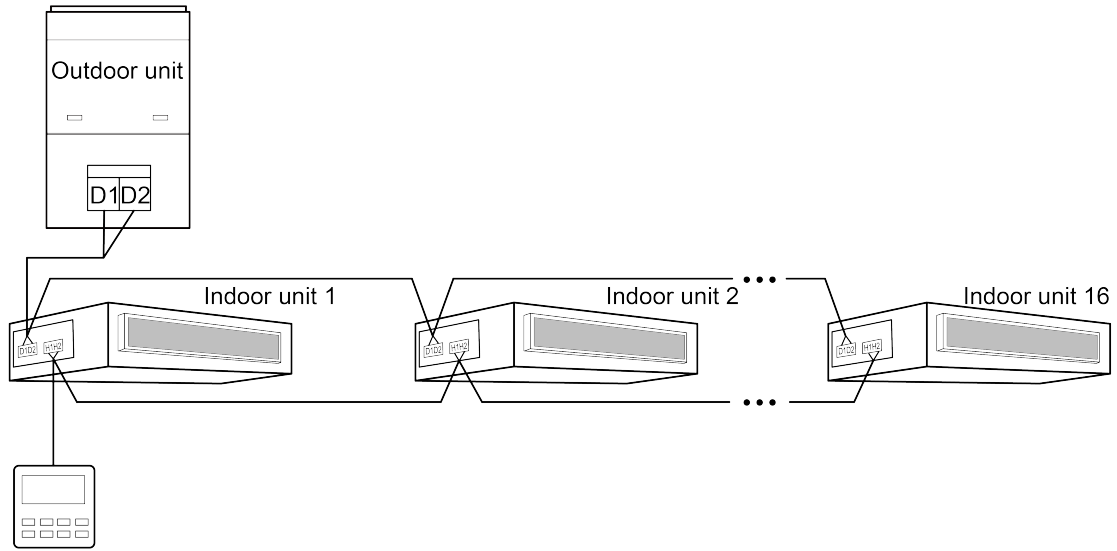

One wired controller controls multiple indoor units simultaneously.

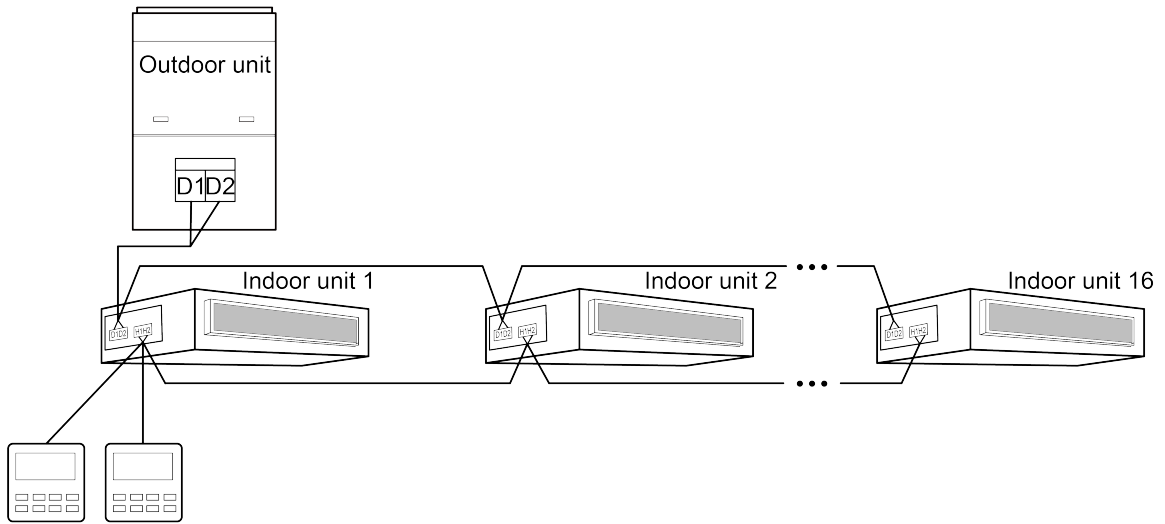

Two wired controllers control multiple indoor units simultaneously.

3 Remote Controller

(1) Remote controller YAP1F

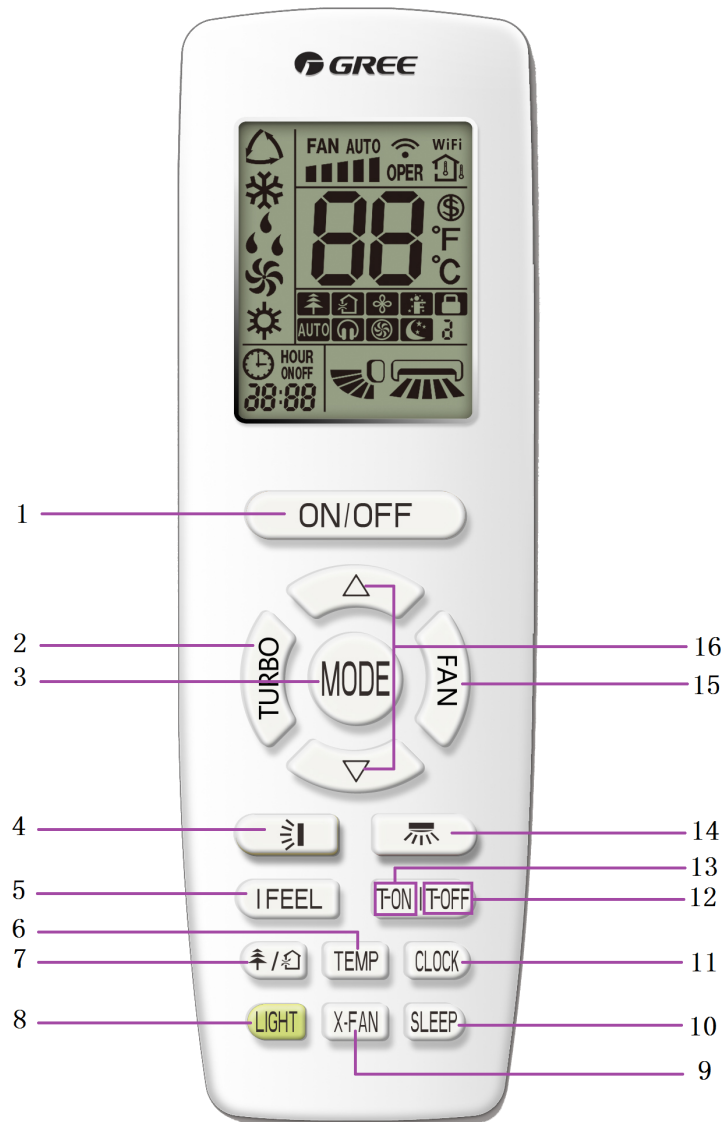





Button name and function introduction

No.	Button name	Function
1	ON/OFF	Turn on or turn off the unit
2	TURBO	Set turbo function
3	MODE	Set operation mode
4		Set up&down swing status
5	I FEEL	Set I FEEL function
6	TEMP	Switch temperature displaying type on the unit's display
7		Set health function and air function
8	LIGHT	Set light function
9	X-FAN	Set X-FAN function
10	SLEEP	Set sleep function
11	CLOCK	Set clock of the system
12	TOFF	Set timer off function

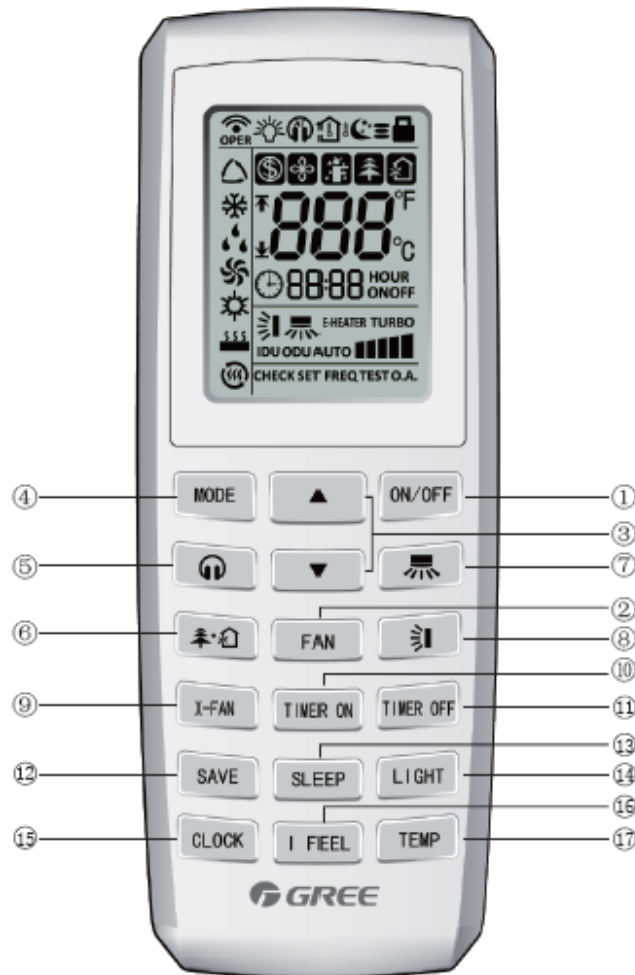
No.	Button name	Function
13	TON	Set timer on function
14		Set left&right swing status
15	FAN	Set fan speed
16	Δ/∇	Set temperature and time

(2) Remote controller YV1L1



No.	Button name	Function
1	ON/OFF	Turn on or turn off the unit
2	FAN	Set fan speed
3	Δ/∇	Set temperature and time
4	MODE	Set operation mode
5		Set quiet function
6		Set health function and air function
7		Set left&right swing status
8		Set up&down swing status
9	X-FAN	Set X-FAN function
10	TIMER ON	Set timer on function
11	TIMER OFF	Set timer off function
12	SAVE	Set energy-saving function
13	SLEEP	Set sleep function
14	LIGHT	Set light function
15	CLOCK	Set clock of the system

No.	Button name	Function
16	I FEEL	Set I FEEL function
17	TEMP	Switch temperature displaying type on the unit's display

4 Monitoring Software

4.1 Function Introduction

With the rapid development of building complex, more and more central air conditioners in various models are used in different places, resulting in inconvenience for the management of air conditioners. Integrating with telecommunication technology and computing software, Gree Commissioning Tool Kits can realize the comprehensive monitor, control and commissioning on central air conditioners. It is an efficient solution for the management of central air conditioners that are separated in different parts of a building. Administrator doesn't need to control every unit on site, but rather controls the units by just sitting in front of a computer. This will not only improve the productivity, but also reduce cost on human resources, property and management.

Gree Commissioning Tool Kits can monitor and control the 2nd generation of Gree Multi VRF. User can monitor and control units by monitoring the computer. This software is an efficient tool for the intelligent air conditioning management as well as installation and after-sales service and commissioning. It can debug units and control units' operation status quickly and conveniently. It will not only improve the productivity but also reduce the difficulty and cost of commissioning and maintenance, providing better and faster service to customers.

4.2 Connection of Computer and Units

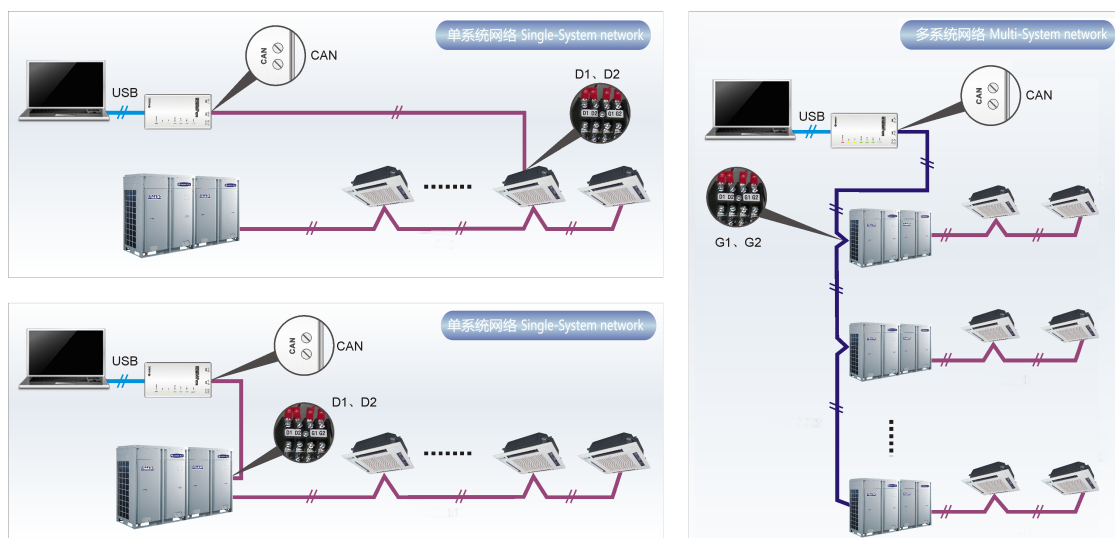

It can be connected with single-system network or multi-system network. In the single-system network, indoor units or outdoor units are connectable, while in the multi-system network, only the master outdoor unit can be connected.

Seen from the diagram, Gree commissioning network is made up of 3 parts:

The 1st part is the monitoring computer, including Gree debugger and Gree USB converter driver that are installed in the computer.

The 2nd part is Gree USB converter, which is to convert the air conditioning communication

into computing communication. This part is made up of Gree USB data converter and USB data wire.

The 3rd part is air conditioners, including outdoor units, indoor units and the connection wires. If connection wire is not long enough, it's OK to connect via the patching board of the commissioning tool kits. In a single-system network, both indoor units and outdoor units can be connected, while in a multi-system network, only the master outdoor unit can be connected.

4.3 Parts Introduction

4.3.1 List of Parts

Name	Model	Material no.	Remark
Gree USB data converter	MC40-00/B	30118027	Convert the air conditioning communication into computing communication
Gree Commissioning Tool Kits (CD-ROM)	DG40-33/A(C)	36400000003	Include Gree debugger, monitoring software, USB driver and USB converter configuring software.
USB wire	\	40020082	Wire connecting computer's USB interface and converter
Communication board	\	30118015	This board can be used when units are far from the computer.
Board connection wire (1m)	\	4001023229	4-core wire connecting units and converter
Board connection wire (5.5m)	\	4001023214	4-core wire connecting units and converter
Instruction manual	\	64134100023	Instruction manual

4.3.2 Gree USB Data Converter

4.3.2.1 Functions Introduction

Gree USB data converter will convert the RS485, HBS and CAN communication within the air conditioners into the communication that is recognizable by computer's USB interface.

4.3.2.2 Appearance

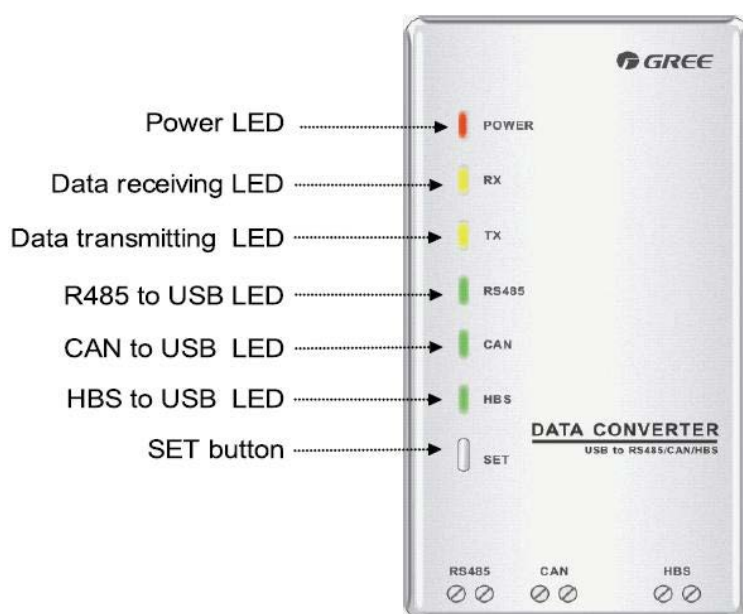

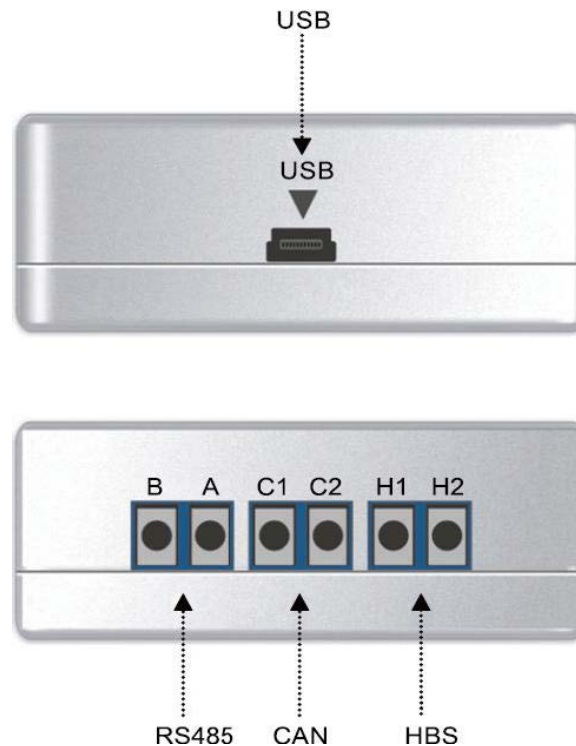

4.3.2.3 Operation Instruction

- (1) Power LED: a red light. If the red light is on, it indicates normal power supply. If the red light is off, it indicates the power supply of converter is not normal.
- (2) Communication LEDs: yellow lights. When converter is working and the computer is transmitting data, the TX data transmitting light will be flickering. When units are uploading data to the computer, the RX data receiving light will be flickering.
- (3) When converter is under RS485 data transferring mode, the function LED of RS485 to USB will be on.
- (4) When converter is under CAN data transferring mode, the function LED of CAN to USB will be on.
- (5) When converter is under HBS data transferring mode, the function LED of HBS to USB will be on.
- (6) USB interface: connect USB data wire.
- (7) CAN interface: When converter is under CAN communication mode, connect air conditioner's CAN data interface. CAN interface exhibits no polarity (A and B are equal).
- (8) HBS interface: When HBS converter is under HBS communication mode, connect air conditioner's HBS data interface. HBS interface exhibits no polarity (This interface is not yet available for Gree debugger and the monitoring software).
- (9) RS485 interface: When RS485 converter is under RS485 communication mode, connect air conditioner's RS485 data interface. RS485 interface exhibits polarity and terminal A and B are different.

4.3.2.4 Installation Notice

- (1) Install indoors. To avoid collision, it is suggested to place it in the monitoring room

together with the computer.

- (2) No need of power supply. Power is supplied through computer's USB interface.

4.3.3 Communication Board

Communication board is mainly used for transferring data. It functions similar with a patching board. Provided that units are far away from the monitoring computer, communication board can be used for connection.

4.3.4 Communication Cord

4.3.4.1 USB Wire

- (1) Connect USB wire with computer's USB interface at one end and with the USB interface of USB data converter at the other end, as indicated below:

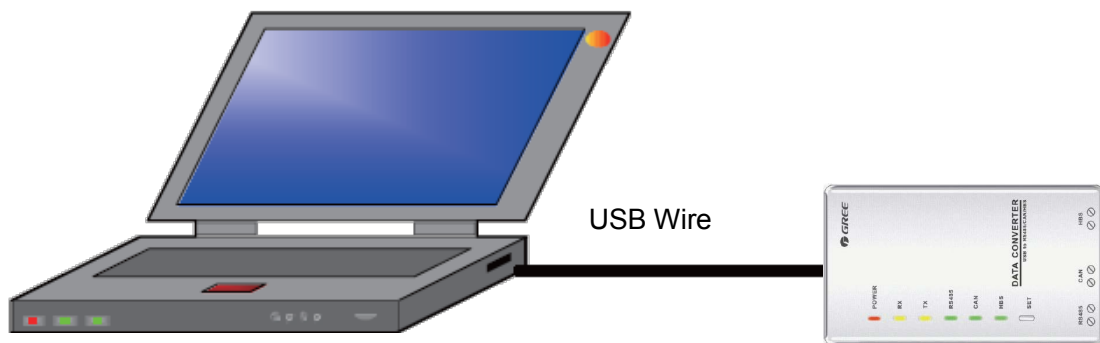

4.3.4.2 Board Connection Wire

- (1) There are 2 board connection wires supplied for the commissioning tool kits. One is 1 meter's long and the other is 5.5 meters' long. They are only different in length. One end of the wire shall connect with air conditioner's communication interface and the other end shall connect with CAN interface of Gree USB converter. As shown below, the wire can be connected to the communication interface of outdoor unit or the communication interface of indoor unit:

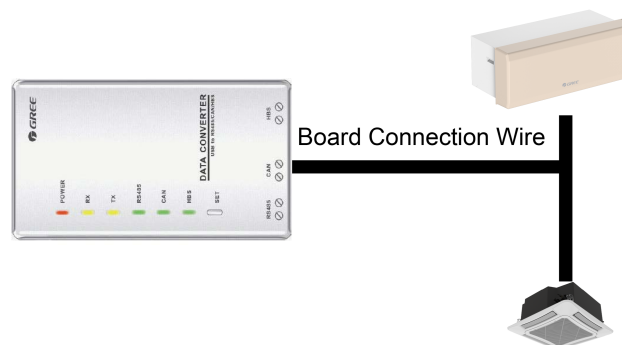

4.4 Software Introduction

- (1) One-button Commissioning.

Personnel responsible for the commissioning of air conditioners can start commissioning by pressing one button according to the commissioning logic of software, which will give the commissioning order to units. Then commissioning will be started up automatically step by step. During the commissioning, the corresponding process will be ticked in green on the software

interface. If any commissioning process is not normal, it will be displayed in red.

(2) Comprehensive monitoring.

The software can monitor every part of the air conditioning system, including functions, equipment and components operating status. The monitoring results will be displayed in text or curve so that user can acquire the operating status of the entire system conveniently and straightforwardly.

(3) Real-time control.

Air conditioner's operating time and requirements may be different based on areas and functions. User can set units' parameters on computer according to actual needs, such as the on/off, temperature, fan speed, mode, etc. Meanwhile, the software can also set or view the function parameters of outdoor units, gateway and other equipment. In this way, the management of central air conditioners is realized.

(4) Replay history.

Software can replay and save the historical monitoring information in the data base. The replay speed can be selected and the information will be shown in text or curve. This function has greatly saved the time to track problem cause and resolved the difficulty of problem reproduction.

(5) Applicable to multiple series, models and users.

Gree Commissioning Tool Kits is applicable to air conditioning system that consists of multiple series and models. Later, it will be developed to cover all series of Gree central air conditioners, such as multi VRF, centrifugal chiller, screw type chiller, ground source heat pump units, modular units, fan coiled units, close control units, etc. It can be used by system and controller designers to develop and monitor units, or used for maintenance and commissioning.

(6) Other functions.

For the convenience of users, the software has added functions like connection guide, printing screen, opening database folder, rebuilding database, changing database saving path, etc.

4.4.1 Software Installation

4.4.1.1 Installation Requirements

(1) Computer Configuration.

Memory	1 GB at least 2 GB or above is preferred
Hard Disc	10 GB available
CPU	Core 2 or higher 1 GHz at least 2 GHz or above is preferred
Operation System	Windows Server 2003 SP3 or higher Windows XP SP3 or higher Windows Vista Windows 7

(2) CD Playing.

Make sure you have administrator access to the computer and there is a CD-ROM in the

computer. Put the CD into the CD-ROM. If it's automatically running, then the following display will be shown. Or double-click the file "Launcher.exe".



For the first time to use Gree Commissioning Tool Kits, install these programmes: .Net Framework 4.0, USB Data Converter, Access Driver (necessary for versions below OFFICE 2007), Gree Debugger.

4.4.1.2 Installation Flowchart

(1) Button Graphics.

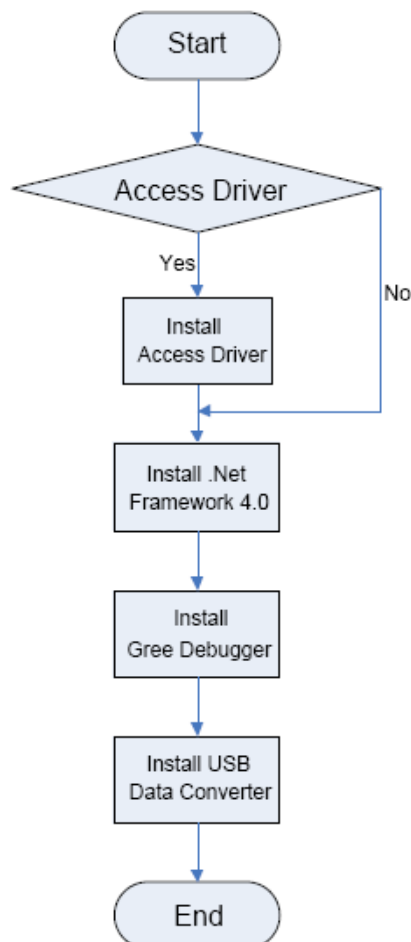

This flowchart describes basically the software installation process. See below for details.

4.4.1.3 Installation Process

(1) Install .Net Framework 4.0.

If your computer has installed .Net Framework 4.0 or versions above, there's no need to install again. Otherwise, click "Install .Net Framework 4.0".



Extracting files.

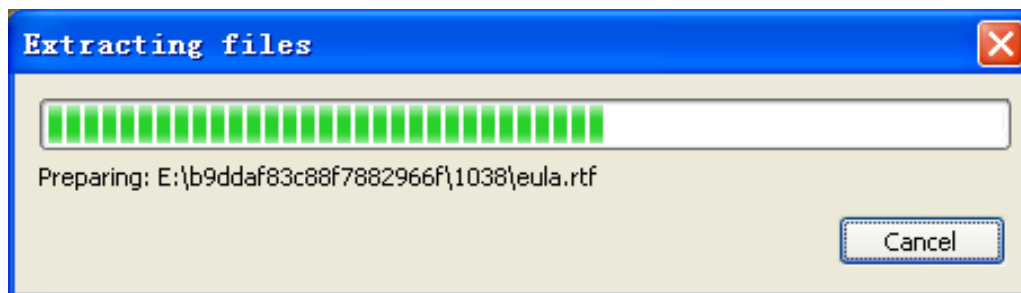

Click and select “I have read and accept the license terms”. Then click “Install”.

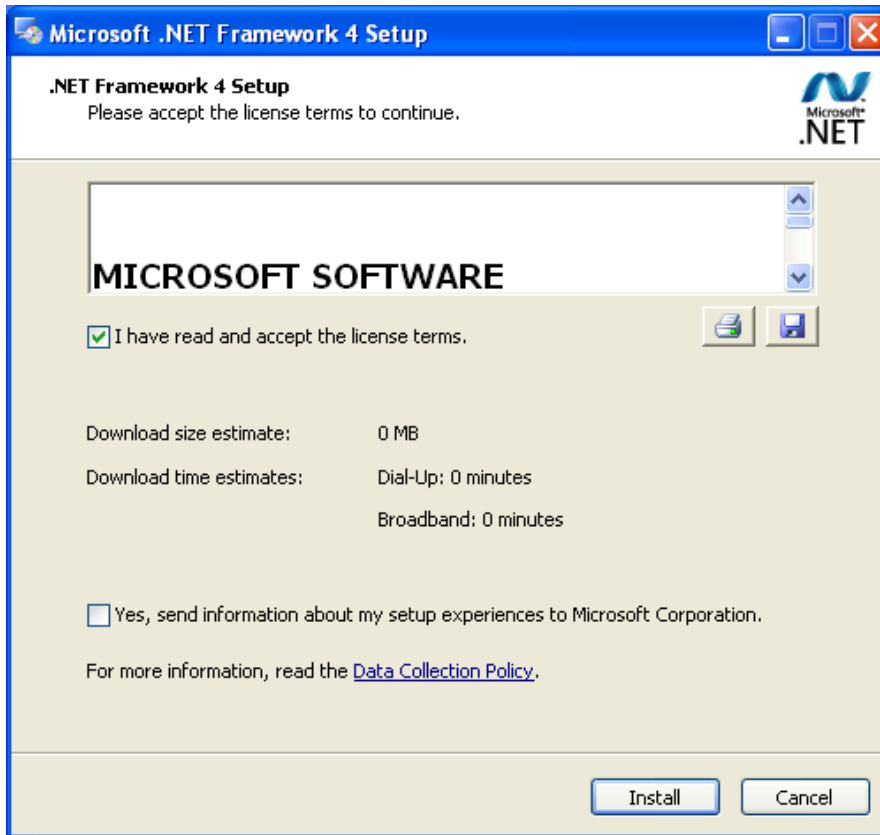

Installation is in progress.

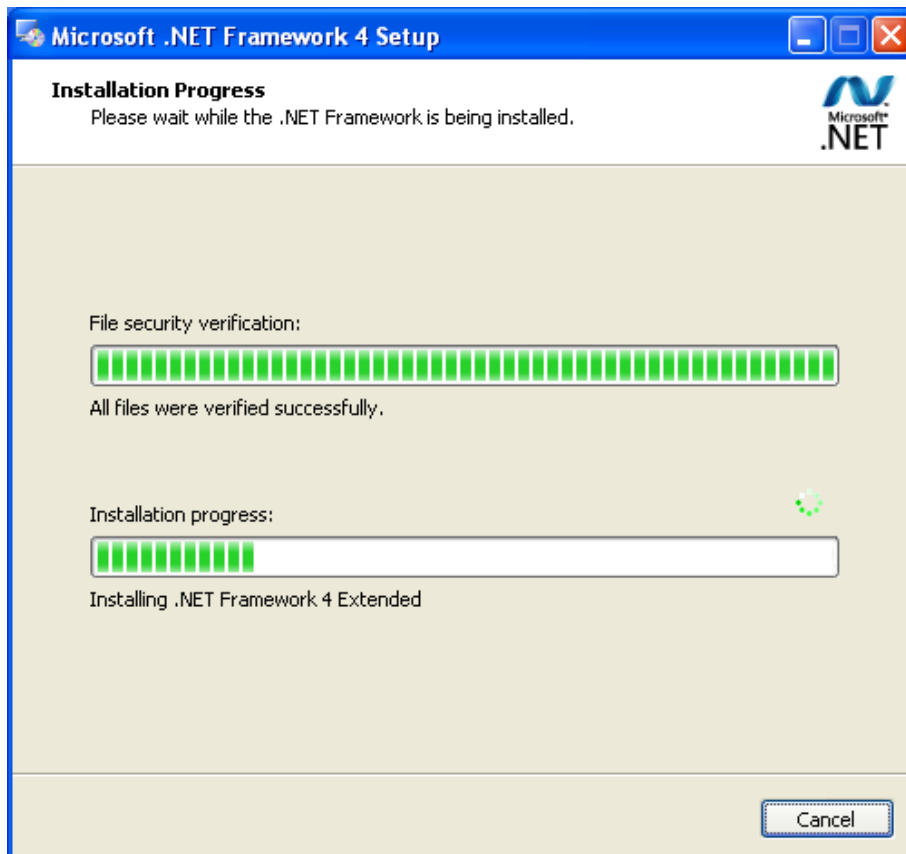

Click "Finish" to complete the installation.

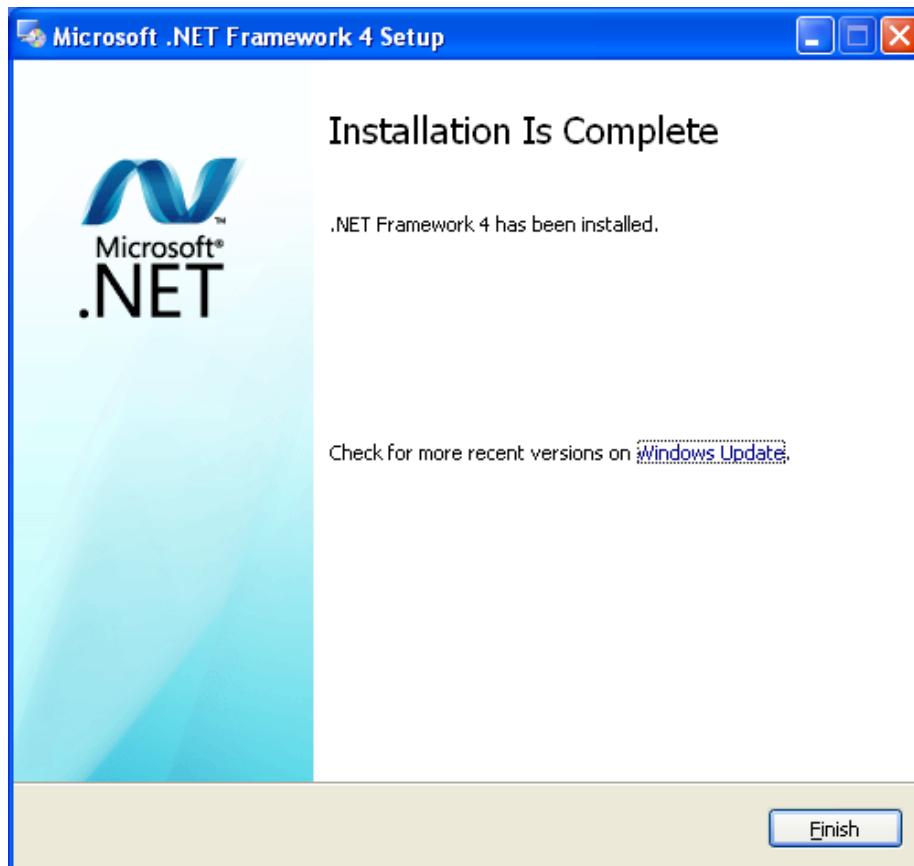

(2) Install Access Driver.

Before operating Gree commissioning software, please first install Access Driver (necessary for versions below OFFICE 2007). Click "Install Access Driver".



Click "Next".

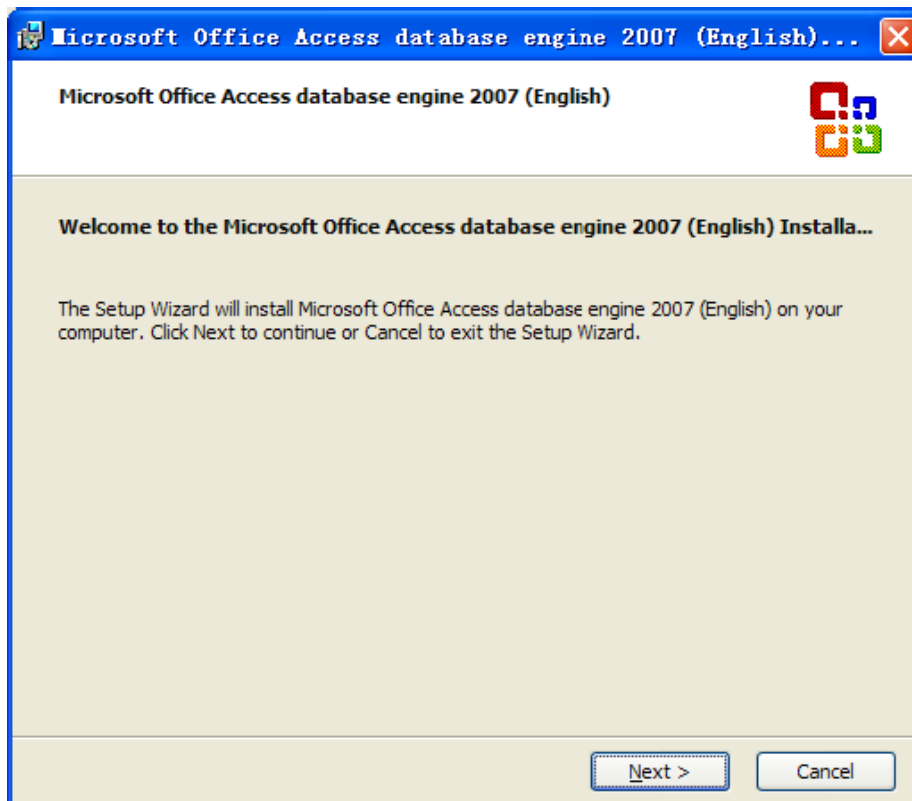

Tick "I accept the terms in the License Agreement" and then click "Next".

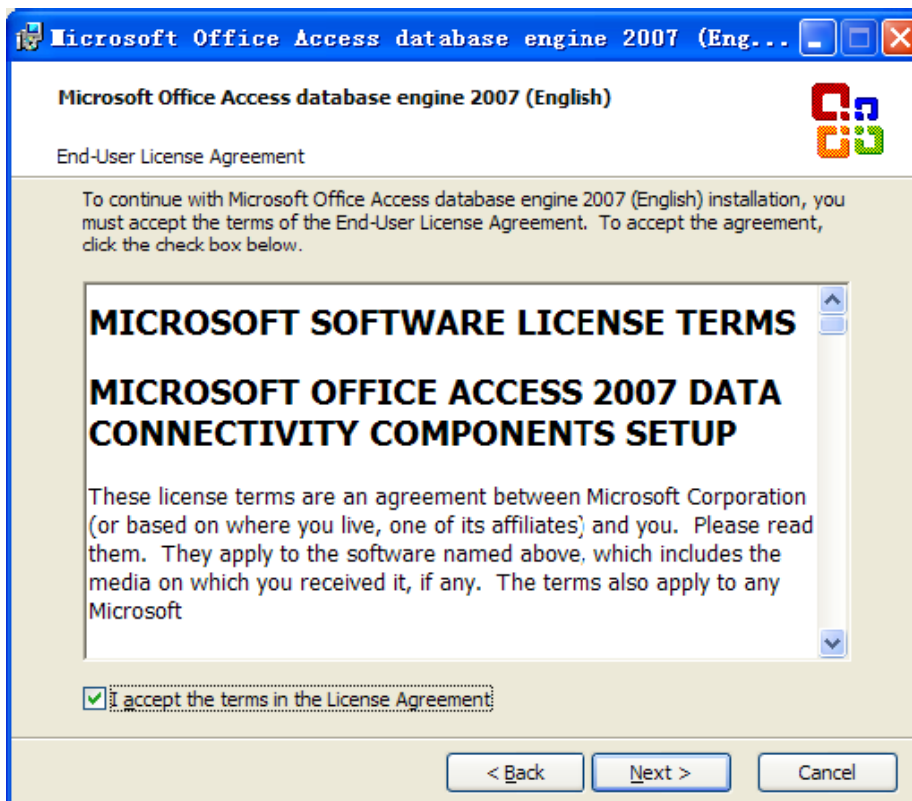

Click “Browse” to change the default folder to the expected one, or click “Install” to continue the installation.

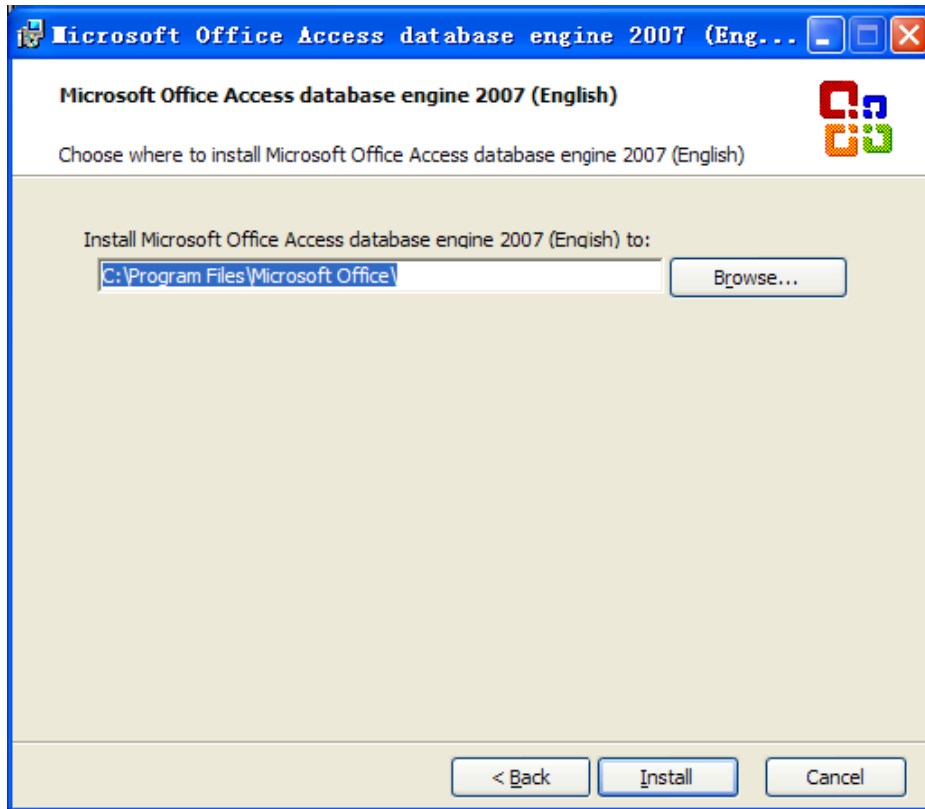

Installation is in progress.

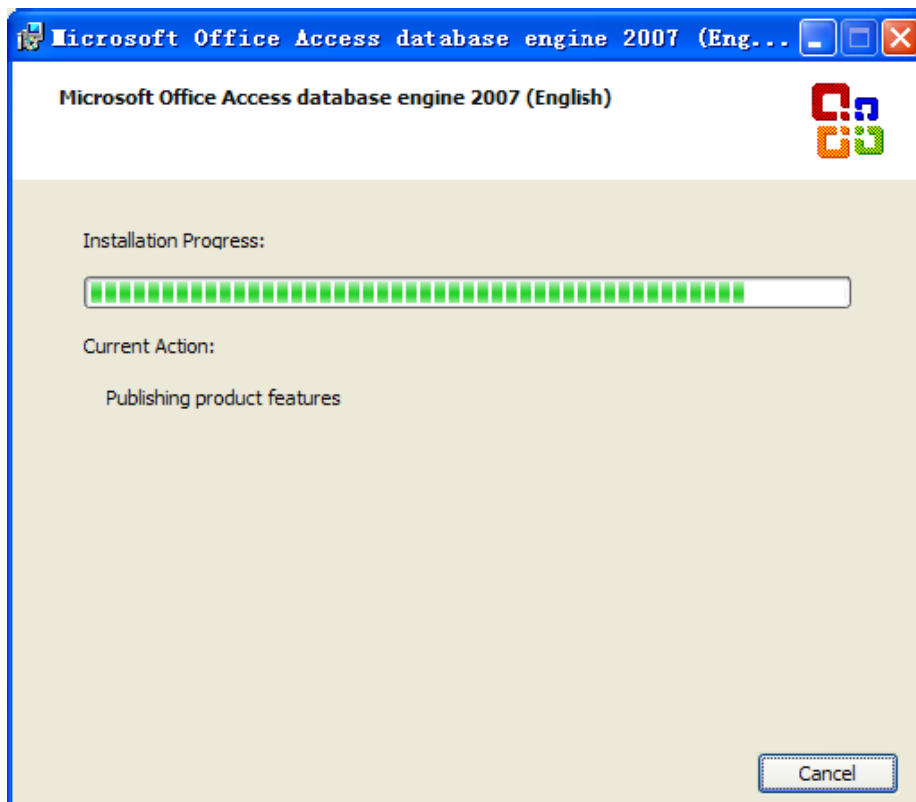

Click "Ok" to complete the installation.



(3) Install Gree Debugger.

Before installing Gree debugger, make sure that your computer is installed with .Net Framework 4.0 or versions above. Then click "Install Gree Debugger".



Click "Next".



Click “Browse” to select installation folder. If no change is needed for the folder, click “Next” to continue the installation.

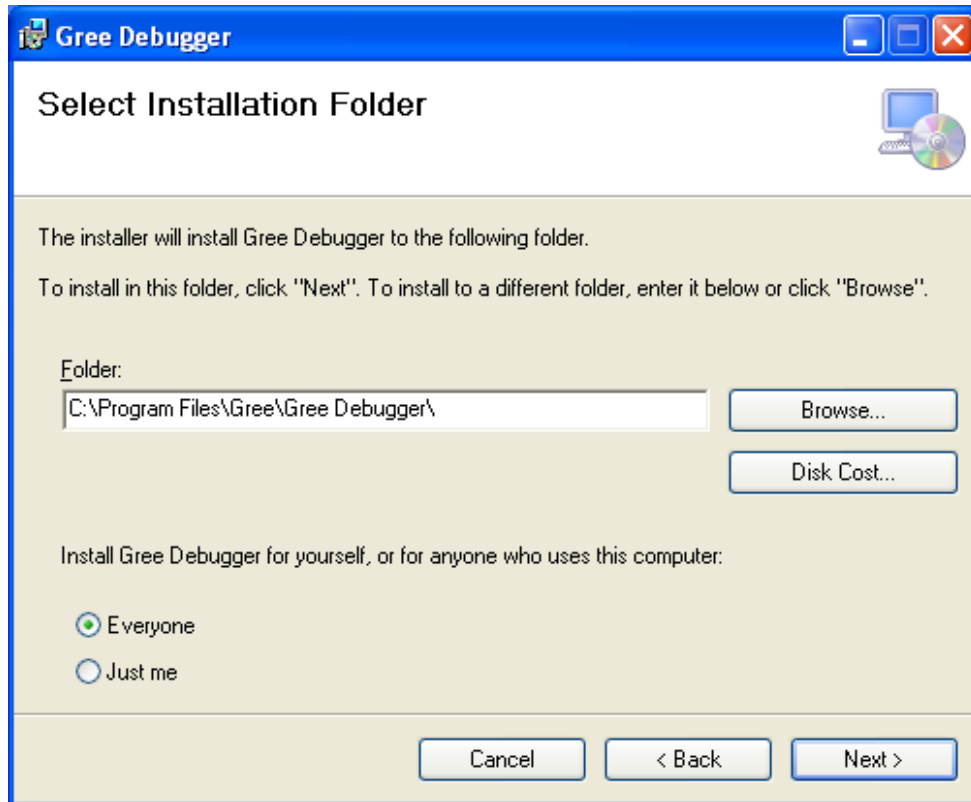

Click “Next”.

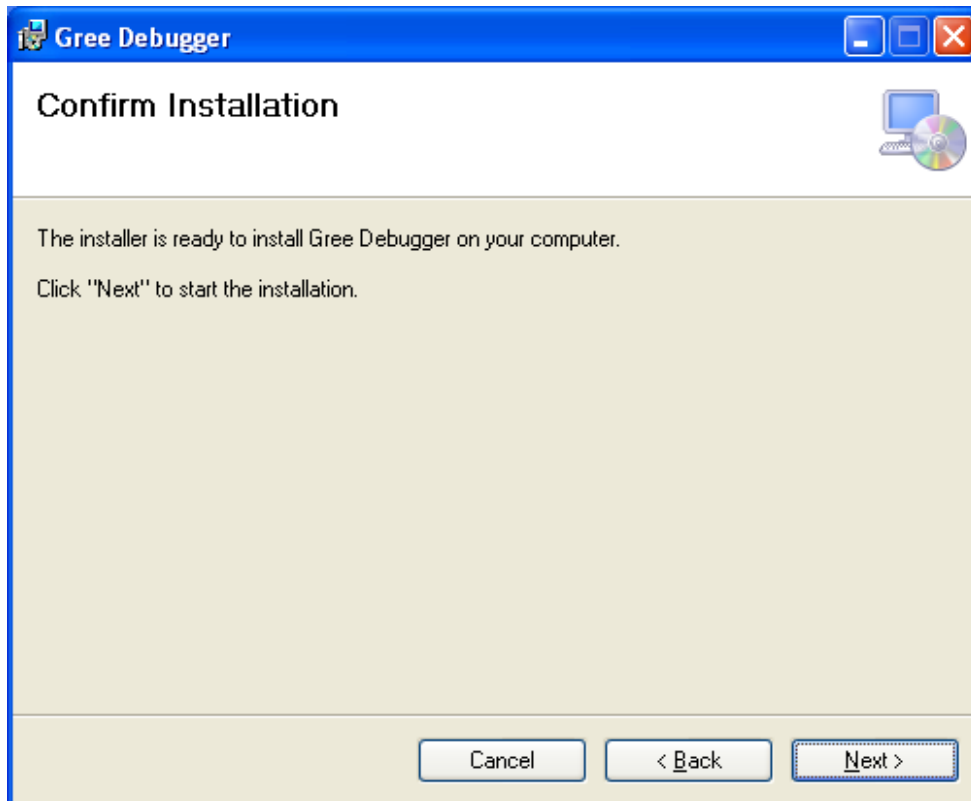

Installation is in progress.

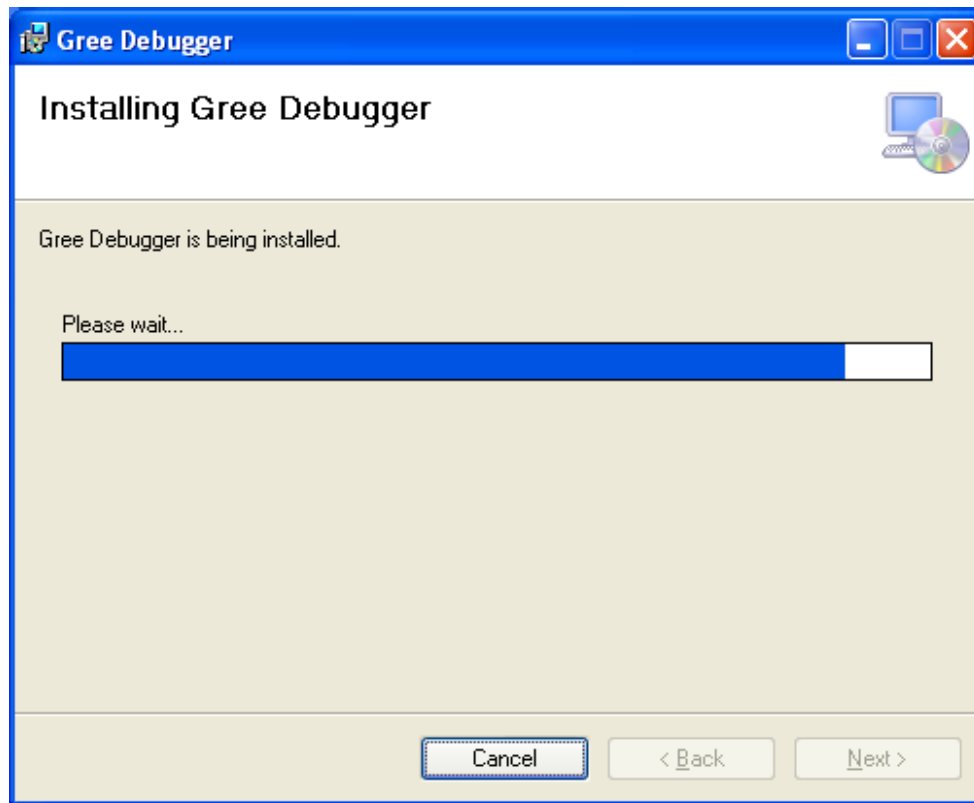

Click "Close" to complete the installation.

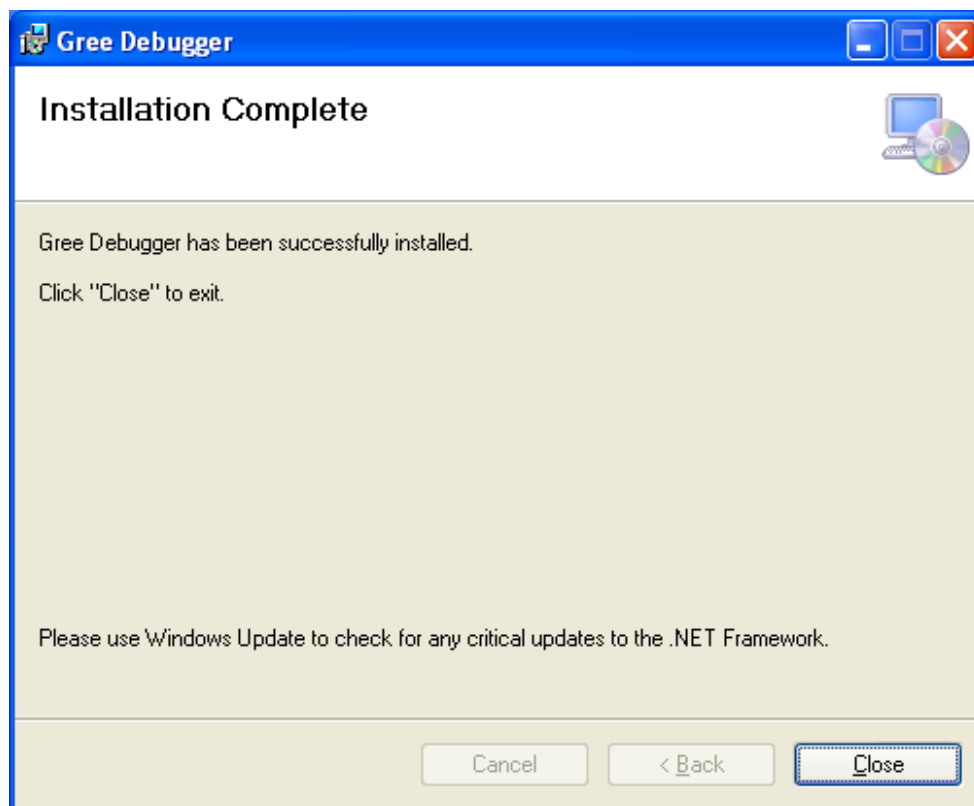

(4) Install USB Converter Driver.

If USB converter driver is already installed in your computer, this part can be skipped. Otherwise, click "Install USB Converter Driver".



Then the following installation window will be shown.

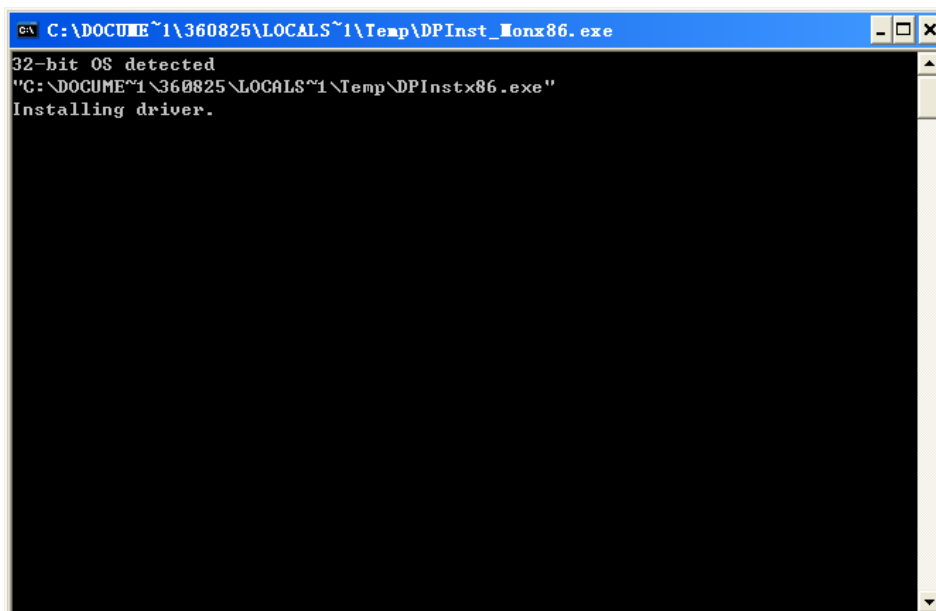

This window will exit after installation is finished.

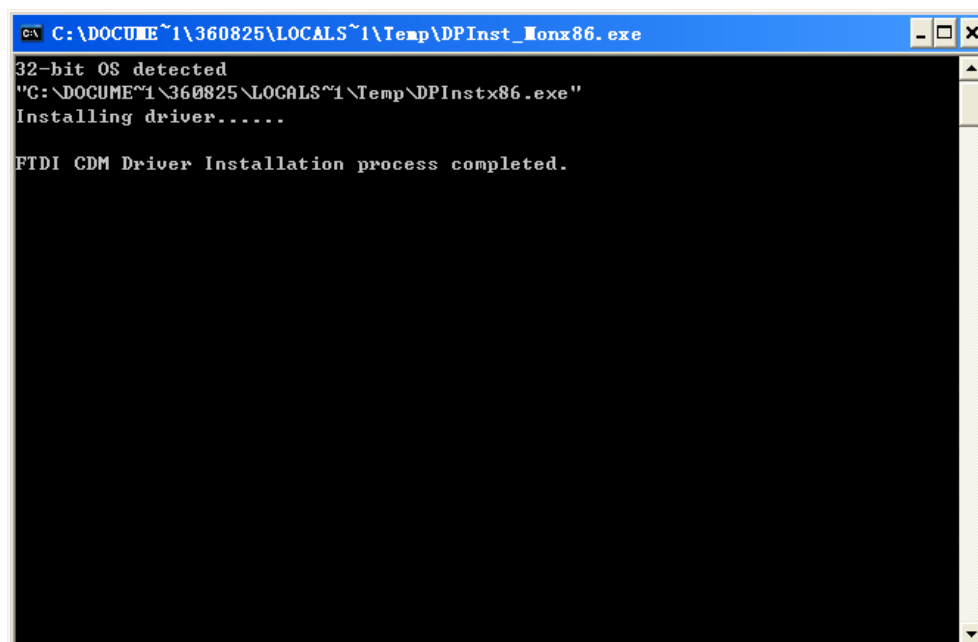

(5) Install Gree USB Data Converter.

If converter baud rate is needed to be set, then converter configuring software must be installed. Click “Install Gree USB Data Converter”.



Then select the setup language. You can choose Chinese “simplified”, Chinese “traditional” or English. Then click “OK”.

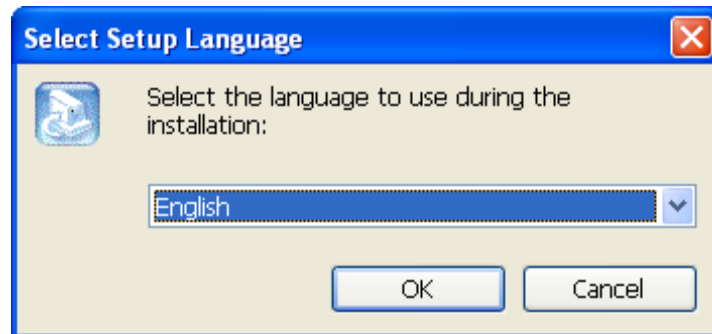

Click “Next”.

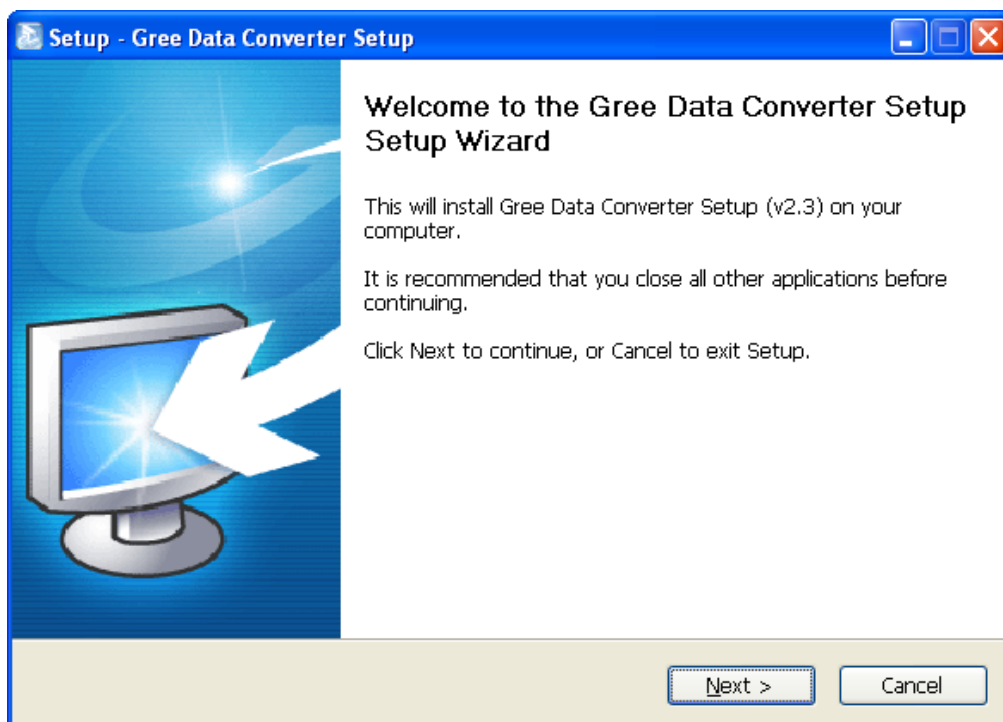

Tick "I accept the agreement". Then click "Next" to continue installation.

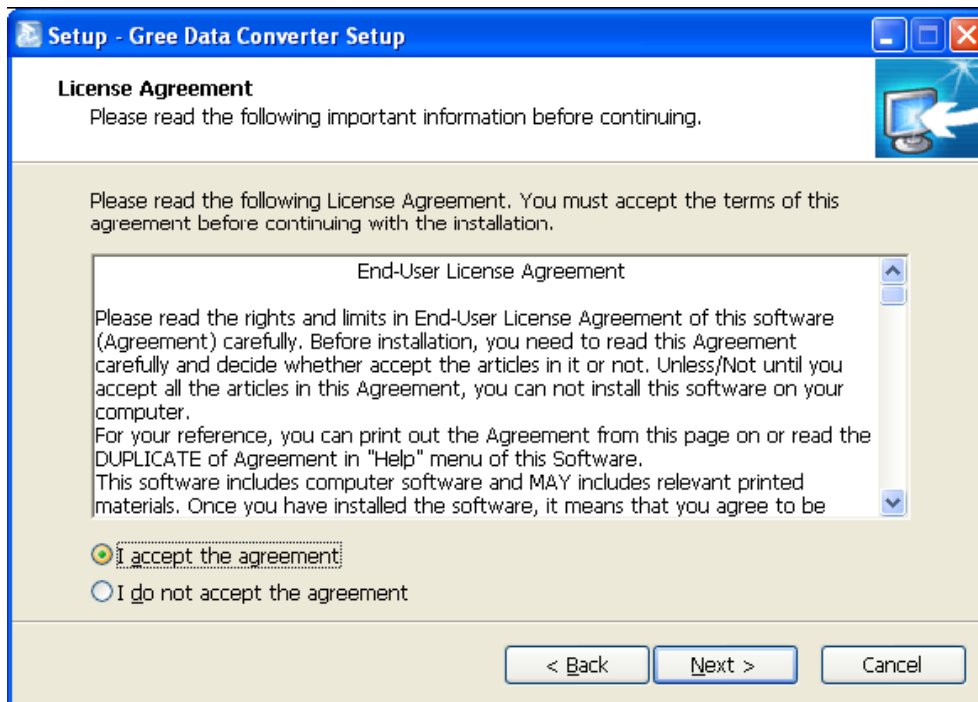

Click "Browse" to select your expected installation folder. Click "Next" to continue.

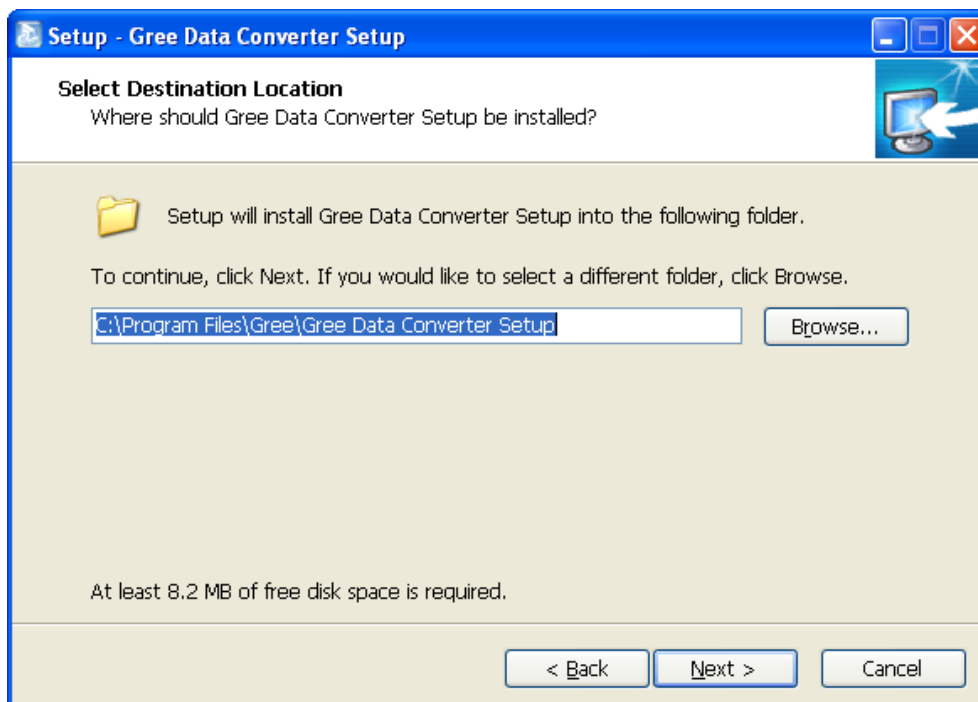

Click "Browse" to change folder. Click "Next" to continue.

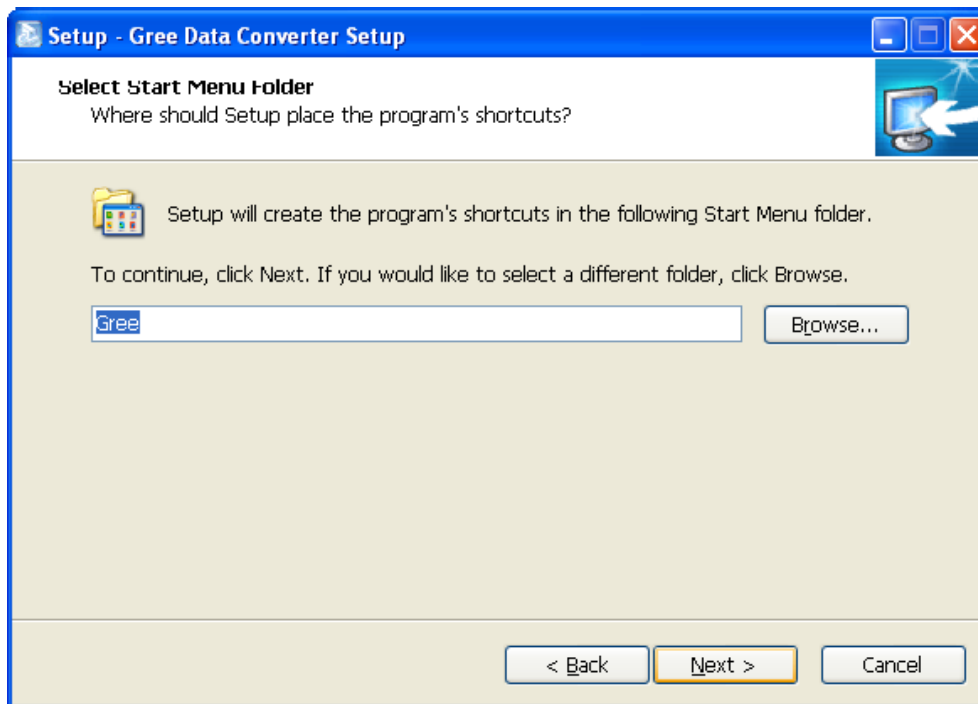

If you want to create a desktop shortcut, tick "Create a desktop icon". Then click "Next" to continue.

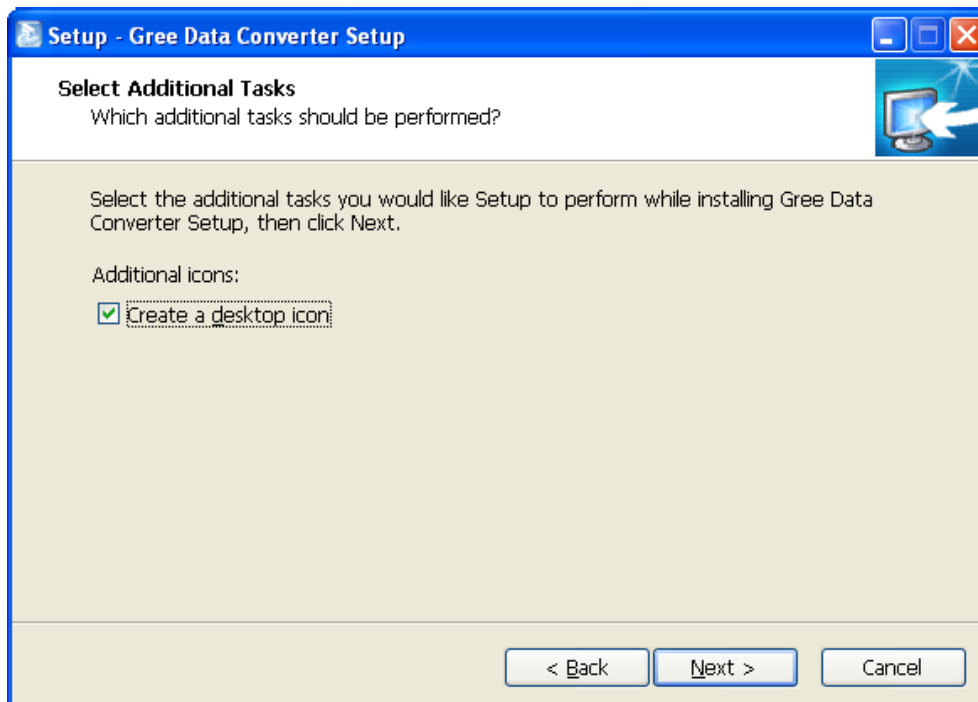

Destination location, folder and additional task will be shown in the next step. If you need to change any of it, please click “Back”. If not, click “Install” to start installation.

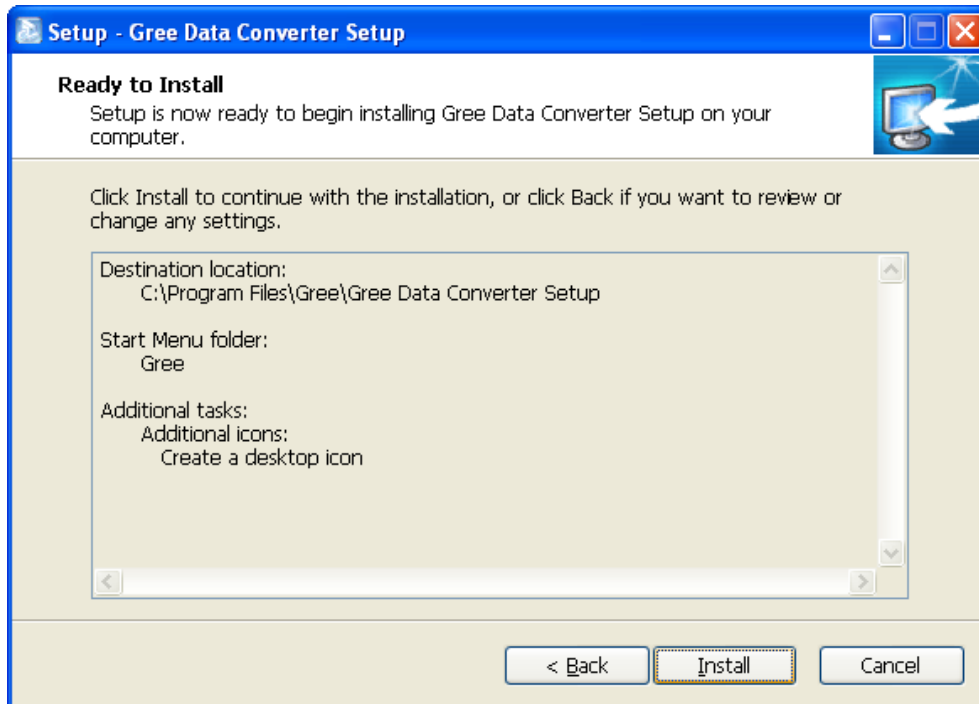

Installation is in progress.

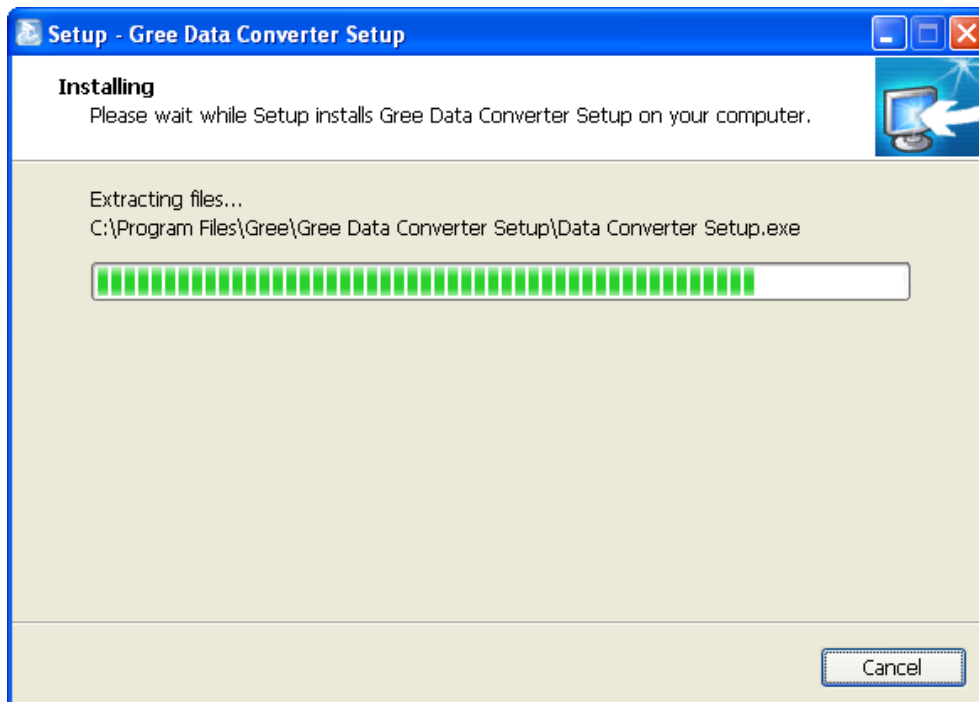

Click "Finish" to complete the installation.

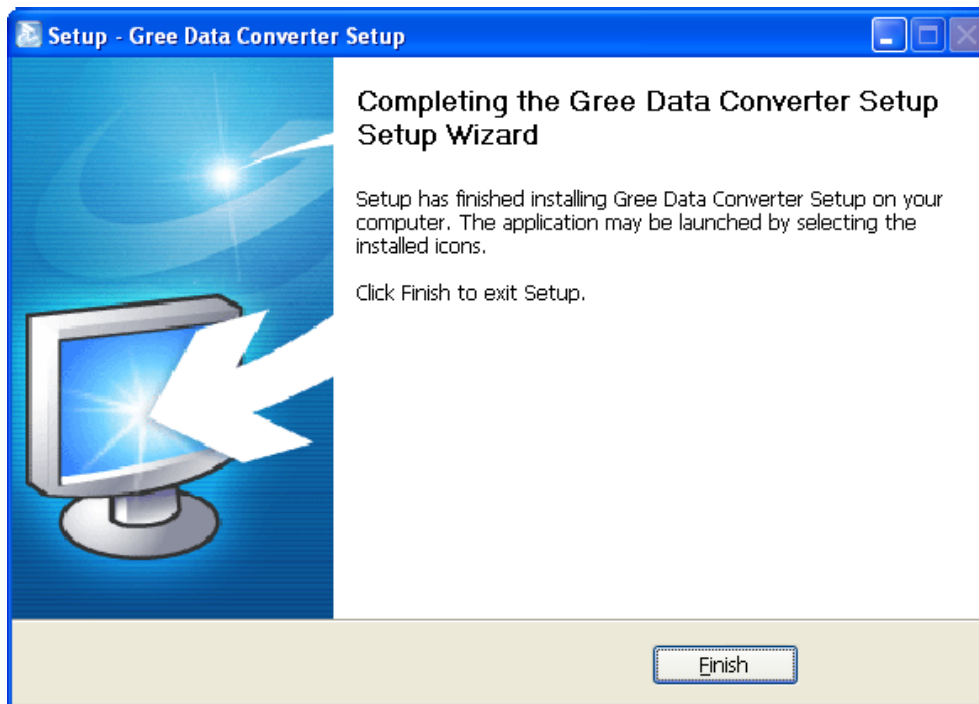

4.4.2 Data Monitoring

Gree Debugger Start up Gree Debugger.



On the original interface, user can select language and units system. Click "OK" to confirm the defaulted language and units system and start up the software.

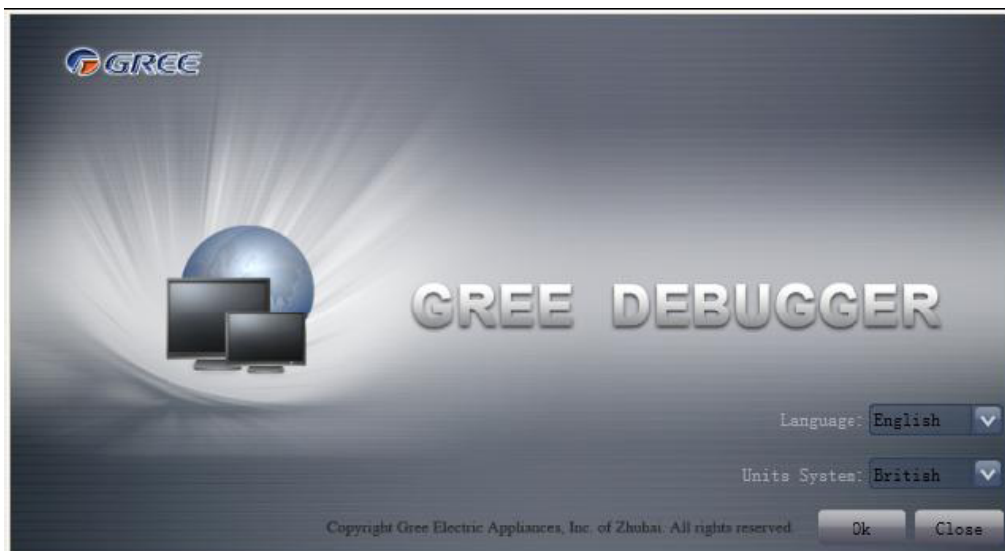

Select language.

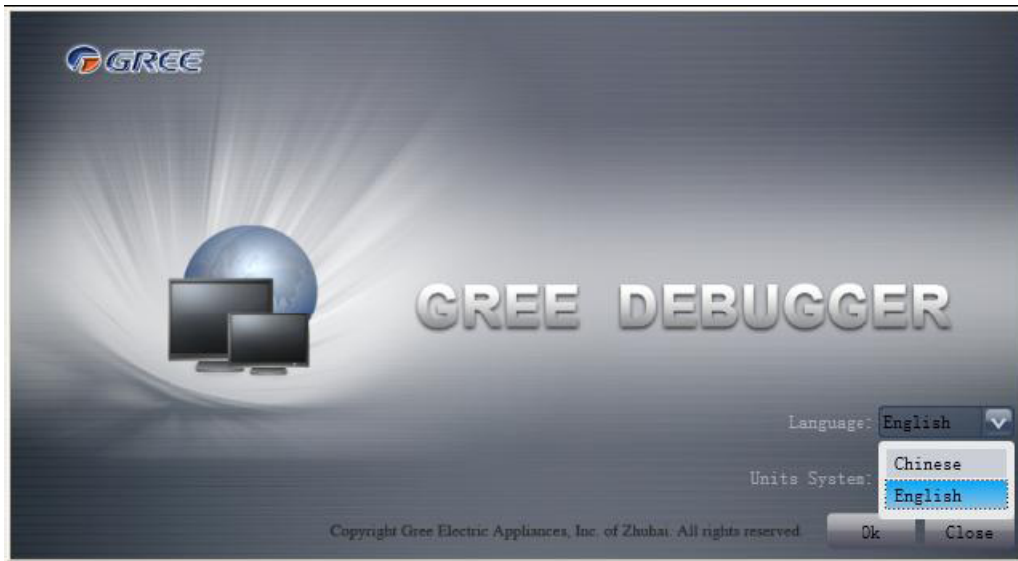

Select system of units.

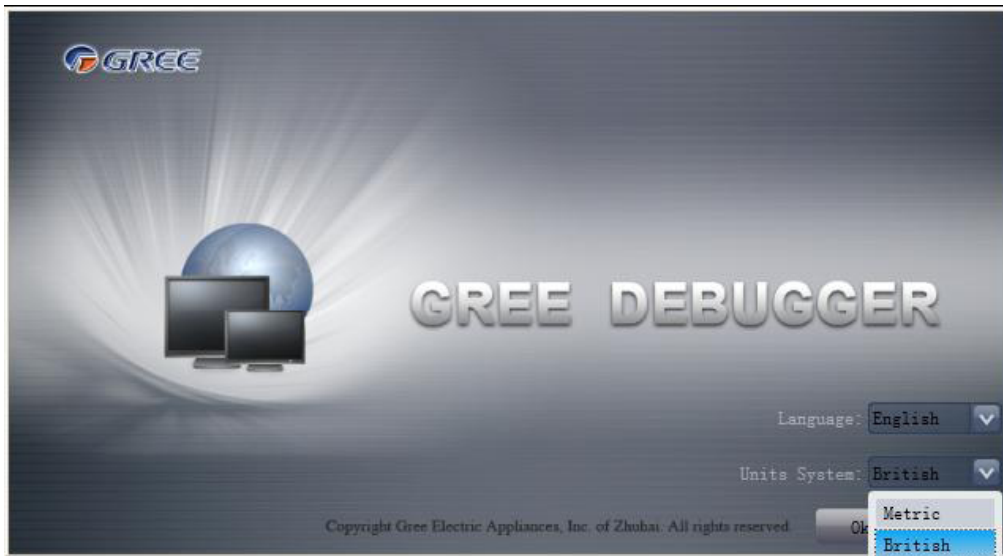

If units you want to monitor are already connected, and able to communicate normally, with correct COM and protocol, then you may click “Connect” to enter the interface of numbers. Otherwise, connect in accordance with the connection diagram shown below.

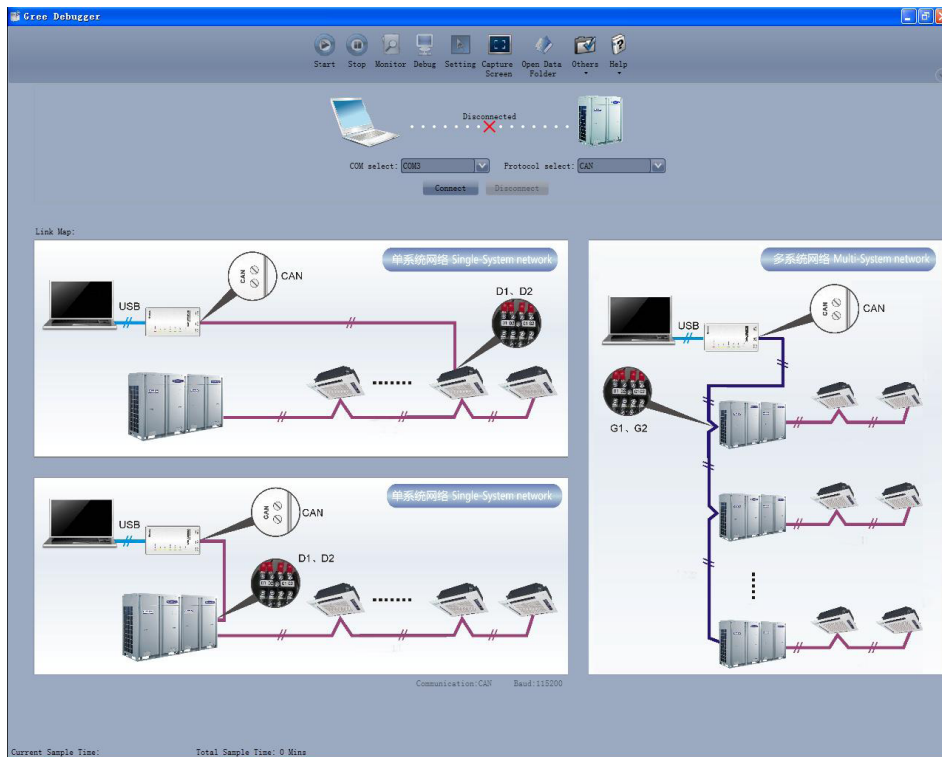

COM selection: the serial port in your computer can be detected automatically. You just need to select your desired serial port.

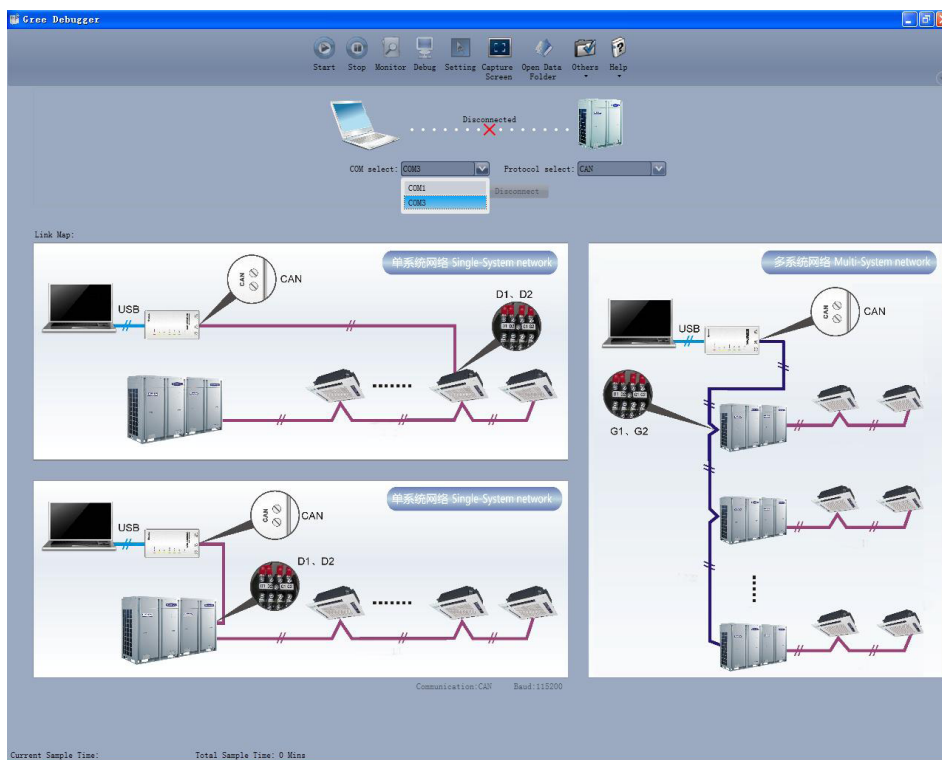

Protocol selection: This is to select the communication method of your units. Currently, CAN is applicable to the units.

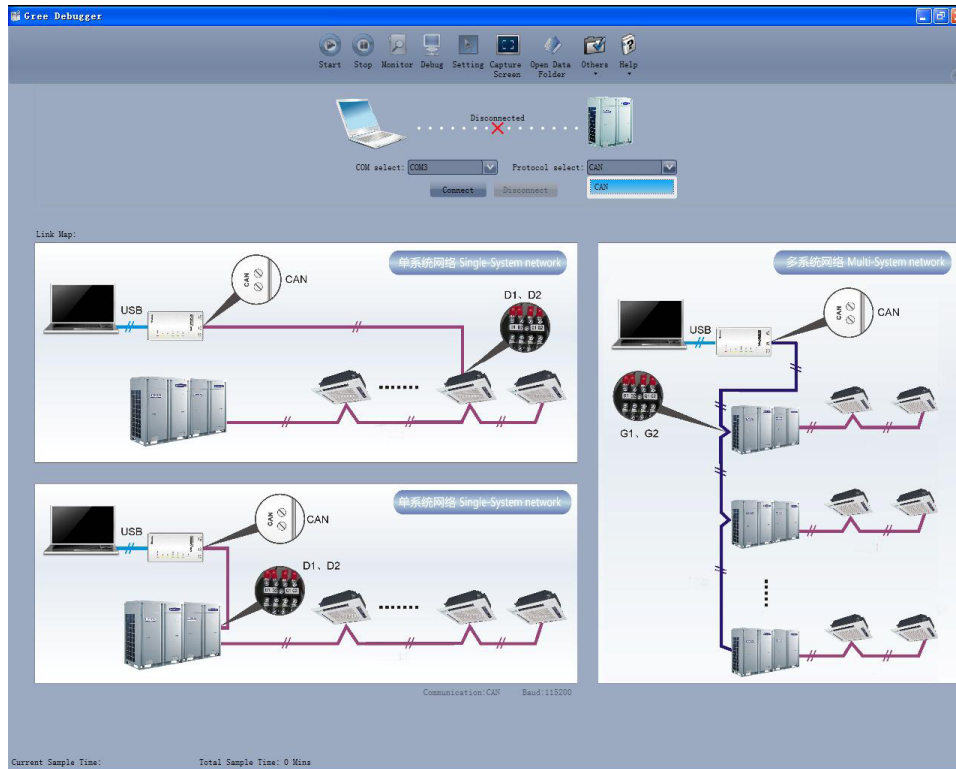

After the selection, click “Connect”. If units can communicate normally with computer, then the interface of numbers will be shown soon. Otherwise, “Connecting” will be shown.

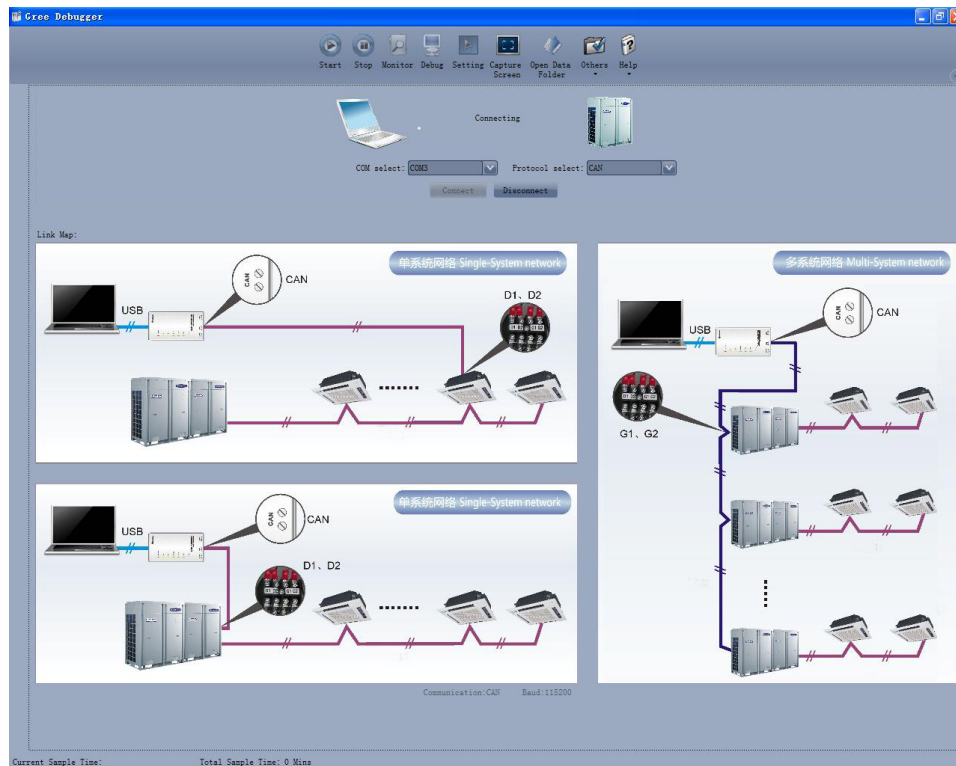

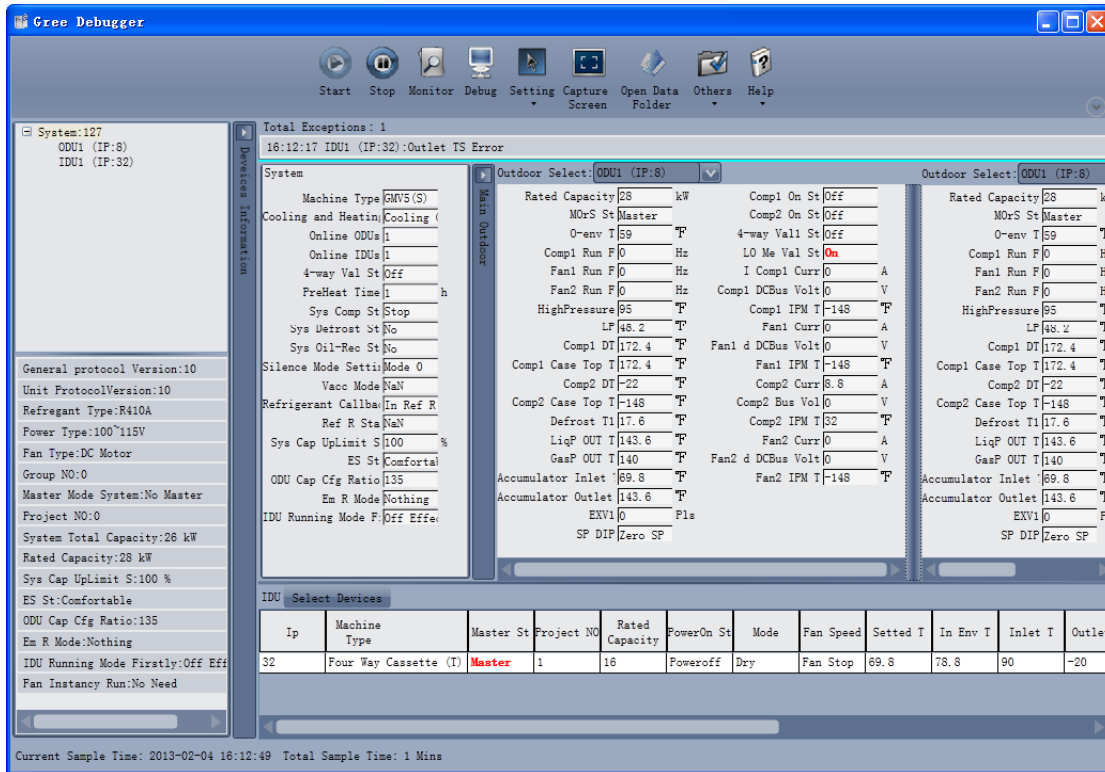

There are several display zones on this interface. You can hide devices information and system information by clicking devices information icon and system icon . Display zones of indoor unit information and errors can be dragged up and down at the dividing lines. As to the display zone of outdoor modules information, it can show information of only one module and hide information of others (two modules are defaulted to be shown). Menu bar can be hidden by clicking icon . Status bar shows the current time and period for data collection.

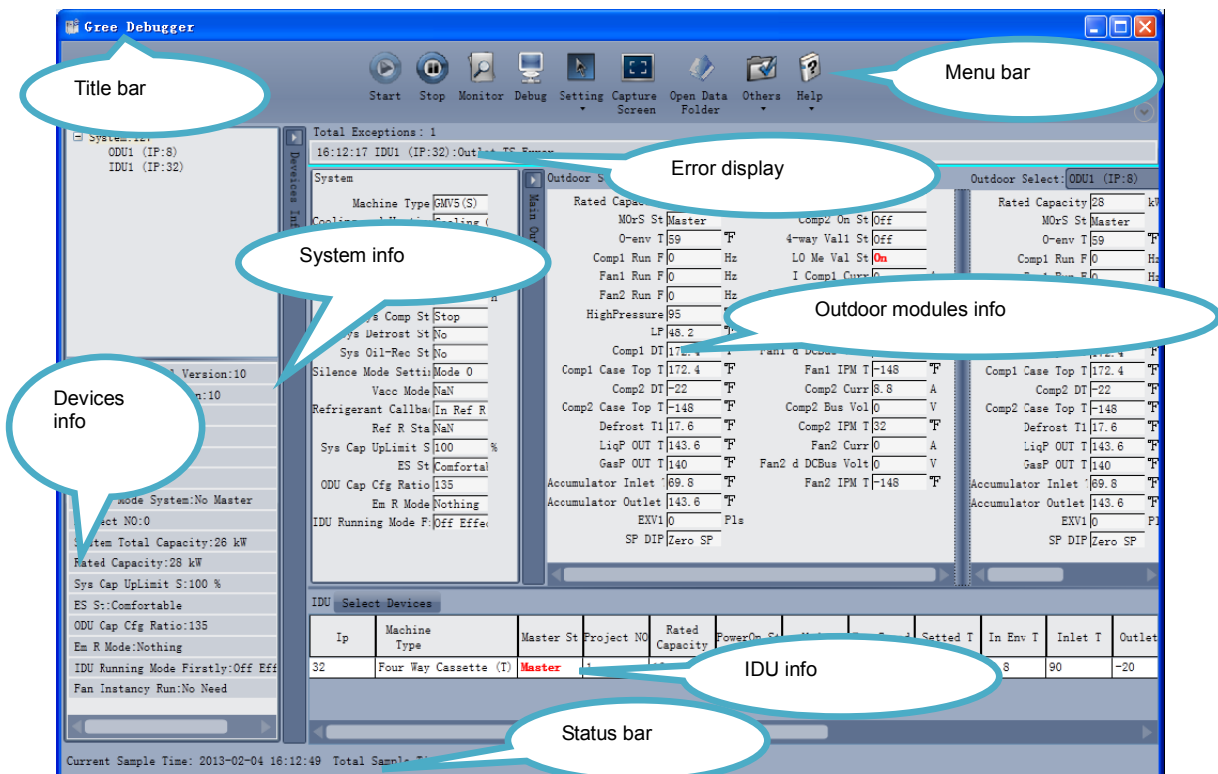

On the display zone of devices information, you may click to select and view units that need

monitoring.

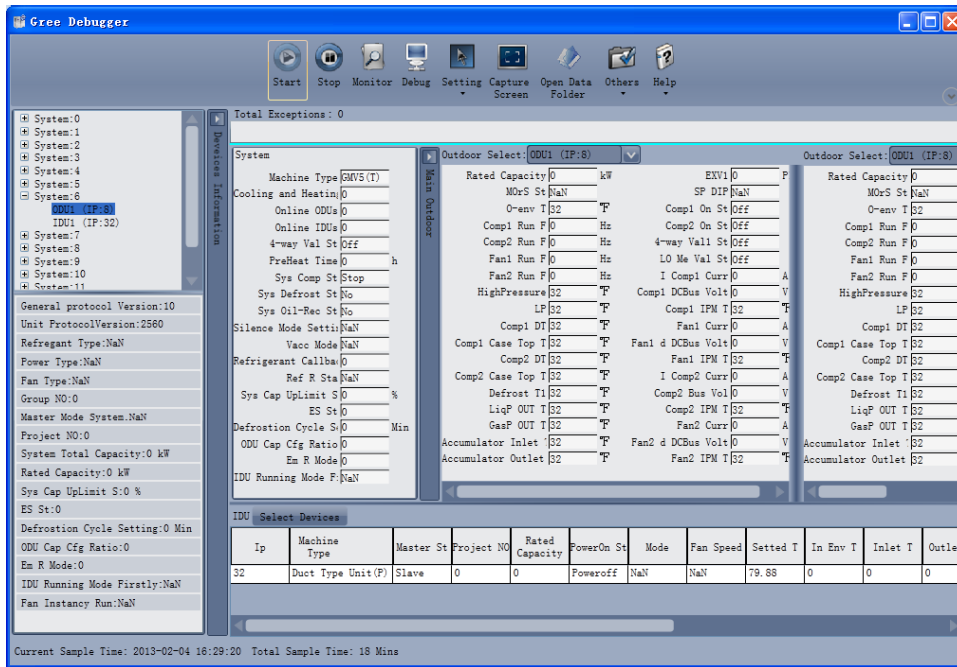

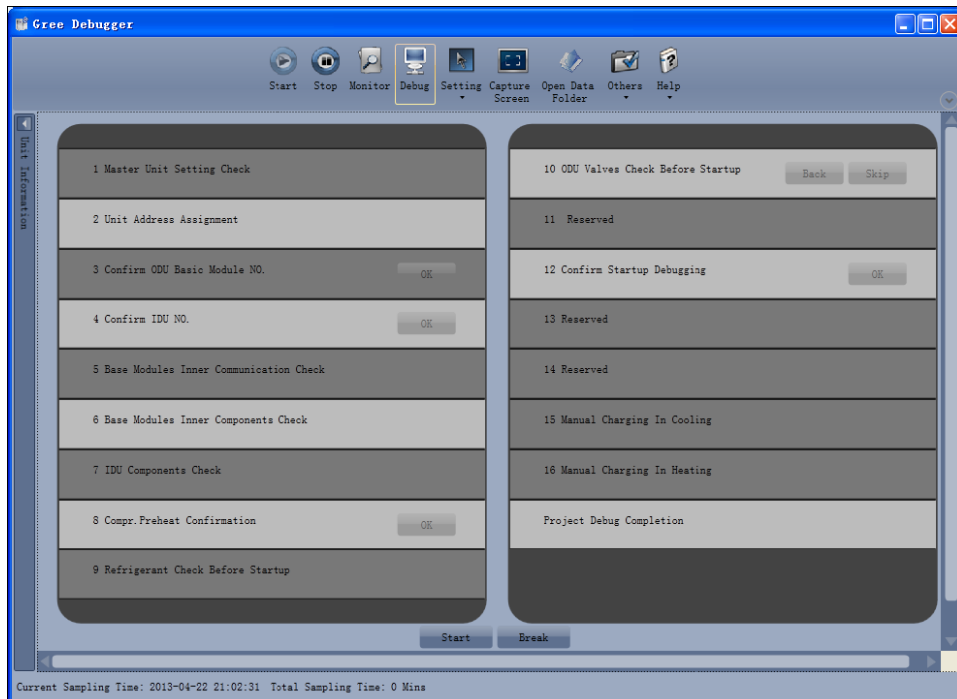

4.4.3 Project Debugging

Click icon of “Debug” on the menu bar and the interface will be switched to project debugging, where auto debugging will be started from up to down and from left to right. **Note:** Debugging function is only applicable to a single-system network.



Click “Start” to enable the debugging function. Then debugging will be started up automatically.

 indicates that debugging is in progress while  indicates debugging is completed.

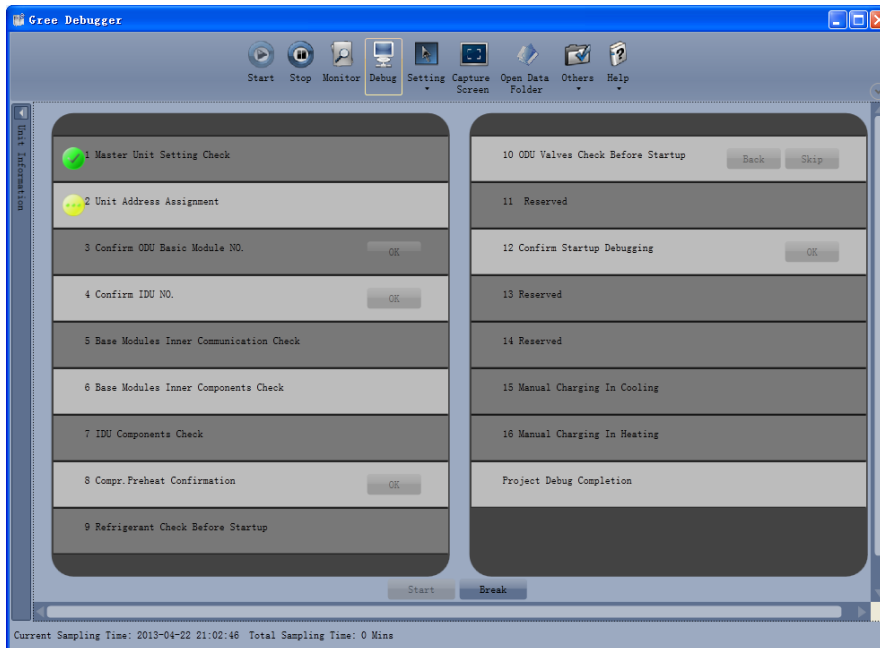

If “OK” button is displayed, it means user needs to judge whether to continue debugging or not. Click icon  and relevant information will be shown for your reference. Click “Close” to close the pop-up (For No.3 Confirm ODU Basic Module NO. and No.4 Confirm IDU NO., the current number of units under debugging will be displayed. See the following marked with circle. For No.8 Compr. Preheat Confirmation, the preheat time will be displayed. See the following marked with circle).

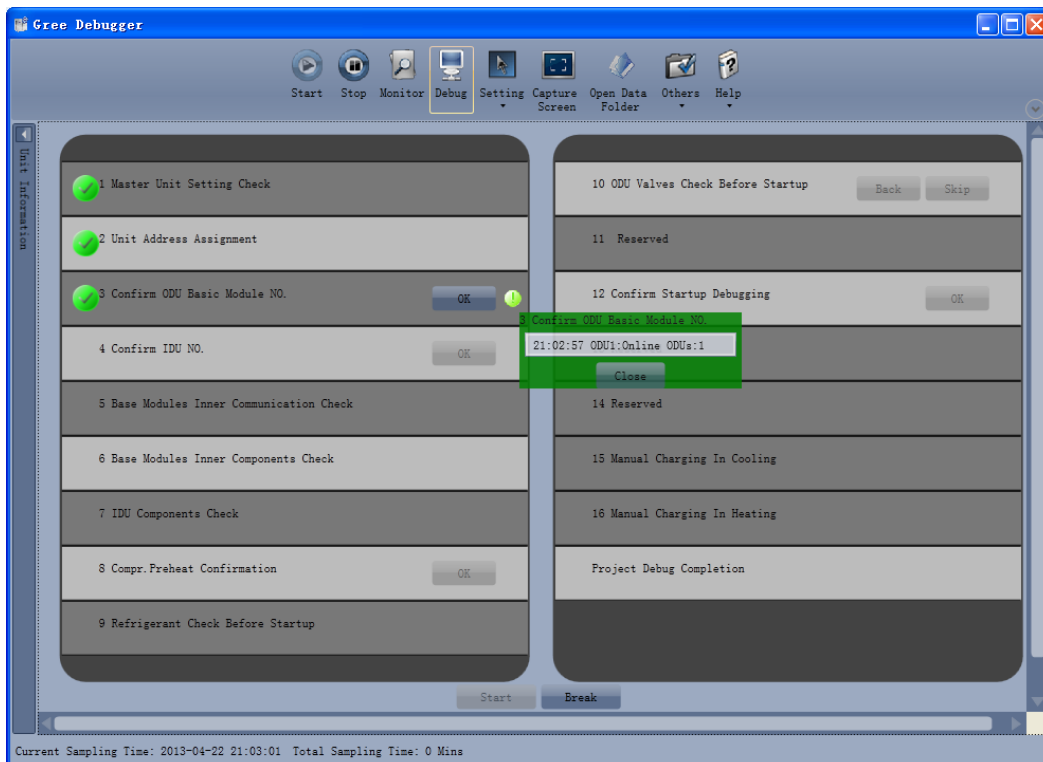

Icon  indicates that there is problem found during debugging. Debugging will not be

completed unless problem is solved (after problem is solved, step without “OK” button will switch to the next step automatically, otherwise user needs to click “OK” to continue). Click icon  and relevant information detected in this step will be displayed for your reference in order to solve problems. Click “Close” to close the pop-up.

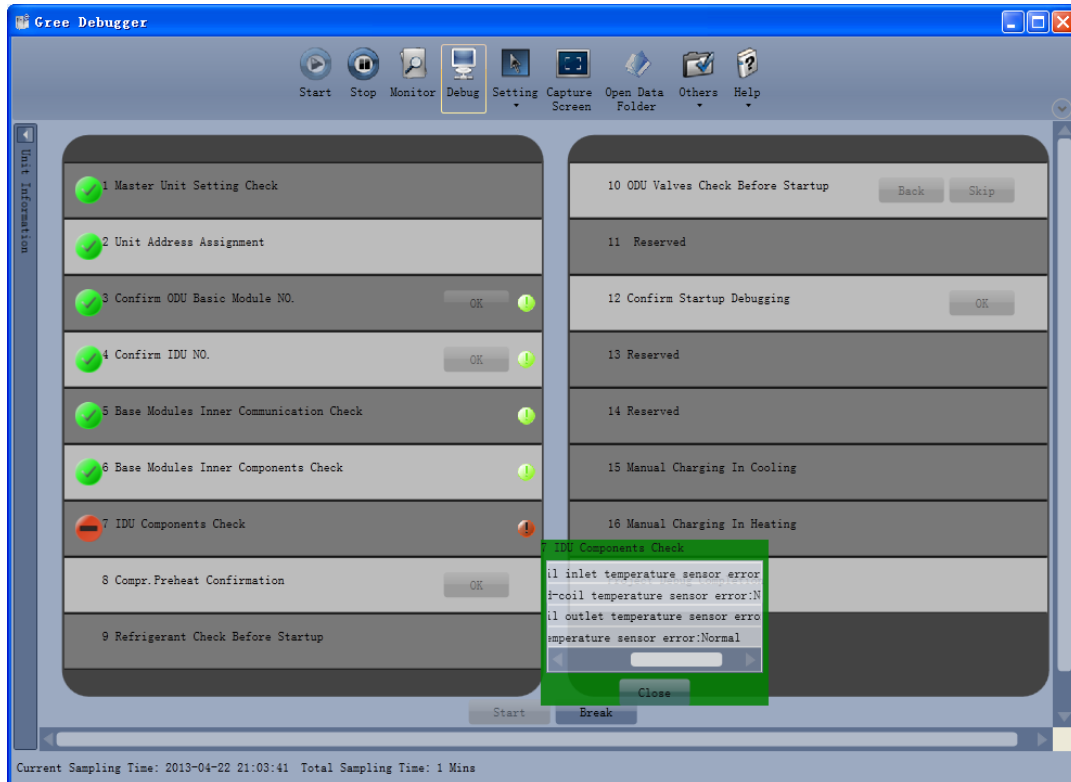

During debugging, a click on “Break” can stop debugging. Click “Start” to resume debugging and then debugging will be finished step by step. For No.10 ODU Valves Check Before Startup, there are “Back” and “Skip” buttons. If there is error in this step, you can back to step No.9 and click “OK” to restart debugging on step No.10. If the error in step No.10 is U6 error (valve error alarm), you can click “Skip”. In other cases, “Skip” button is null.

Step 11, 13 and 14 are reserved steps. And step 13, 14, 15 and 16 are steps in parallel (only one of the four will be selected according to actual needs).

4.4.4 Control Units

Click icon of “Setting” on menu bar and select parameter settings, which include “Gateway Settings”, “IDU Settings”, “System Settings”, “Project Number Conflict (In case there is project number conflict in indoor units, other functions will be shielded. Then this parameter needs to be set in order to eliminate the conflict)” and “System Historical Info”. Click the corresponding set and adjust the parameters.

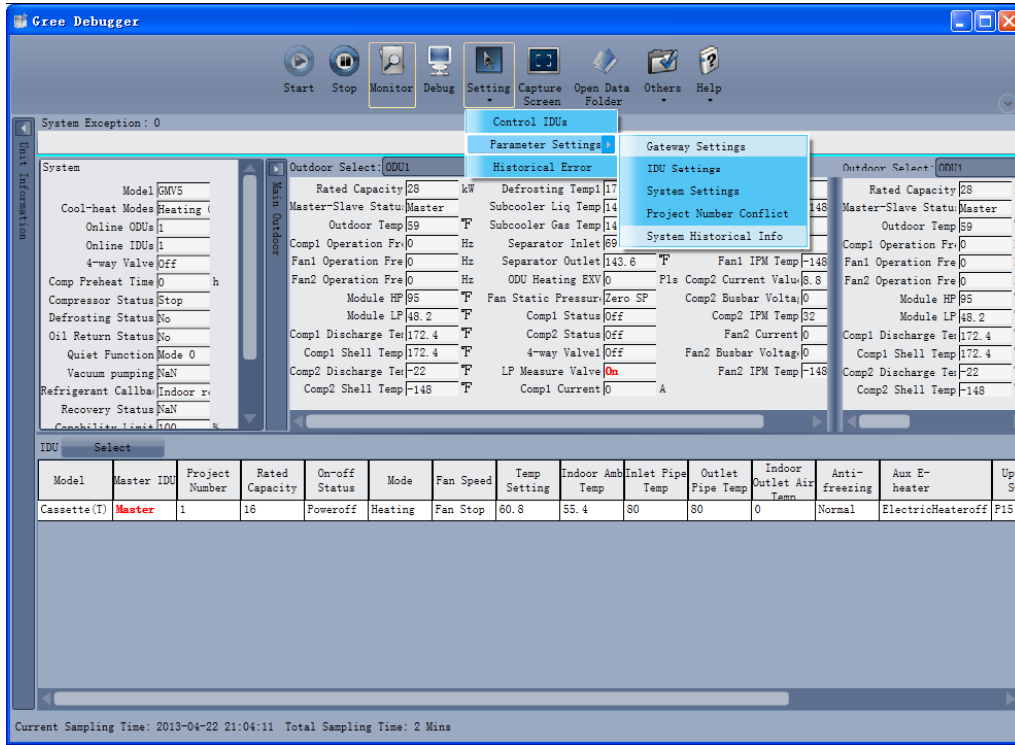

Take indoor unit as an example. Click “IDU Settings” and a dialog box will pop up.

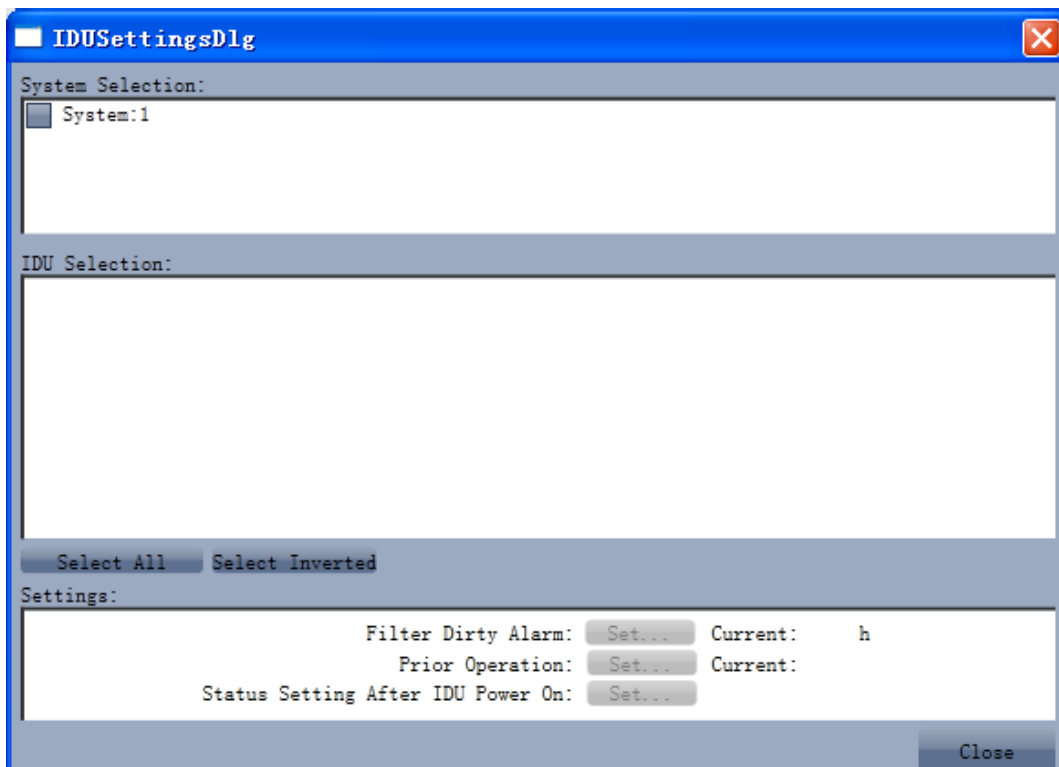

Tick the indoor units that need setting in the IDU selection zone or you may click “Select All” to select all of them or “Select Inverted” to select none of them. After selection, the current values of the corresponding parameters will be displayed in the zone of settings. Click “Set” and then click  in the pop-up dialog box to select values. Click “Set” and then the corresponding order will be sent to units. If setting is successful, it will be displayed at the current values.

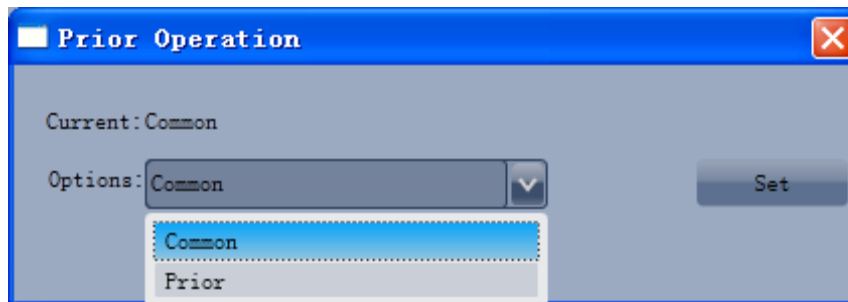
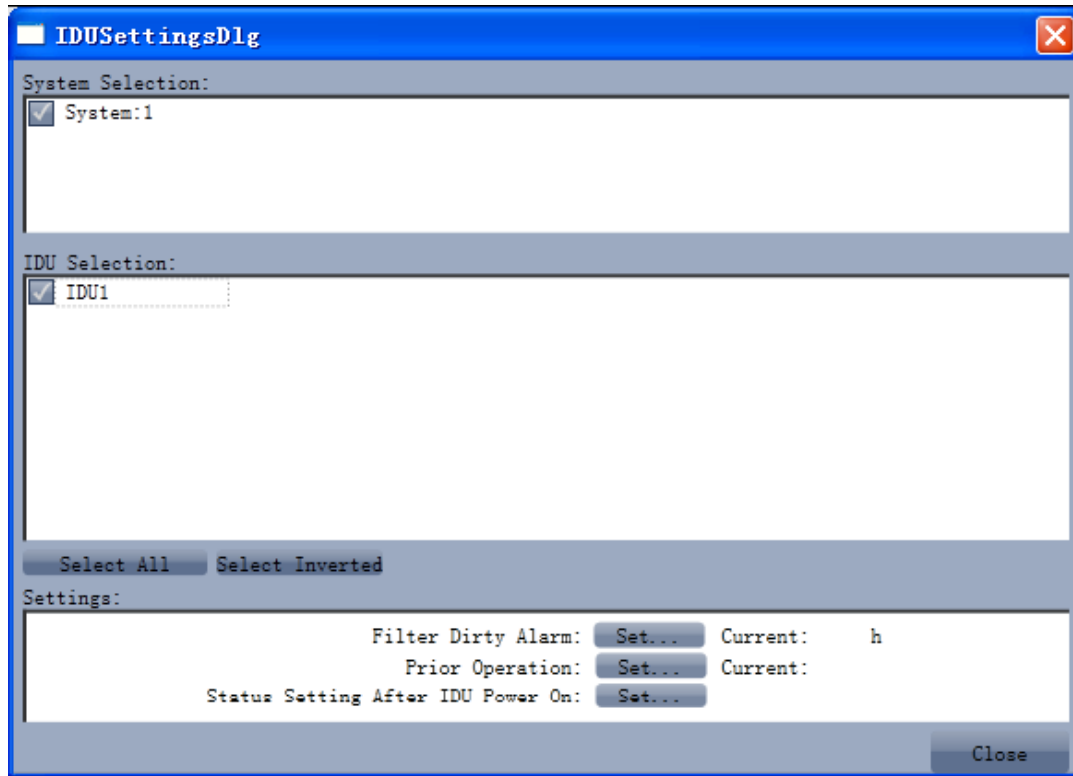

4.4.5 Other Functions

(1) Capture screen.

Click icon of “Capture Screen” to print the interface. If you want to open the interface, click “Open”.

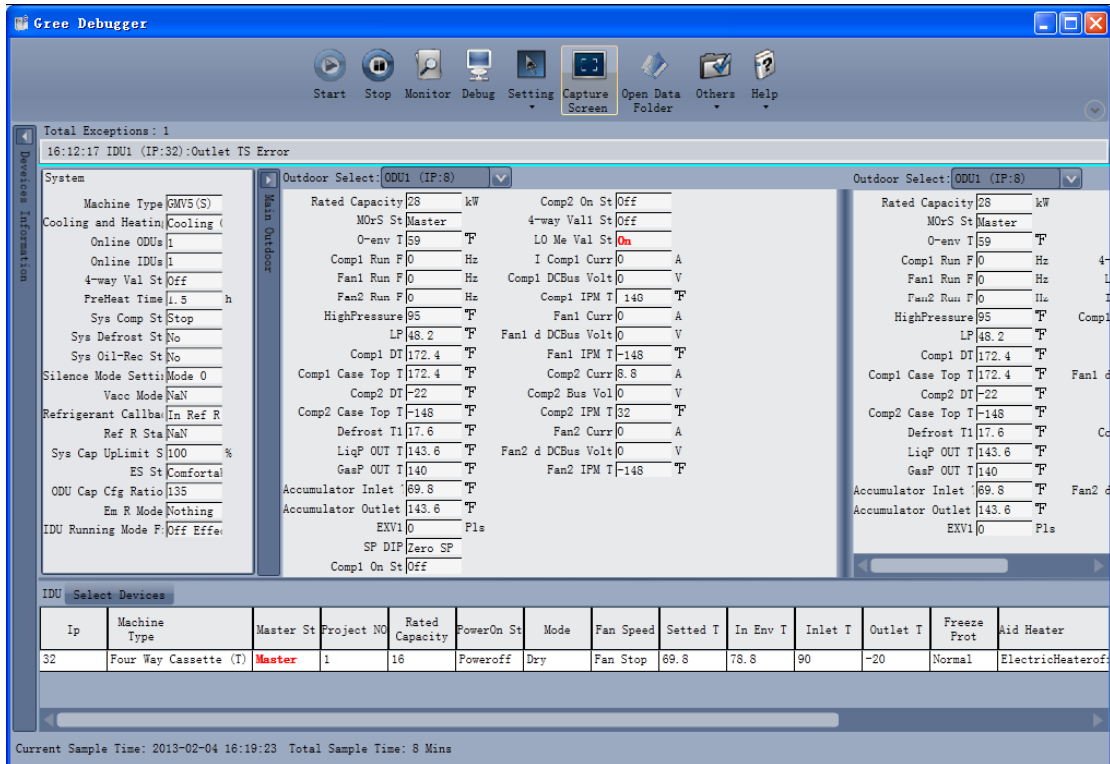
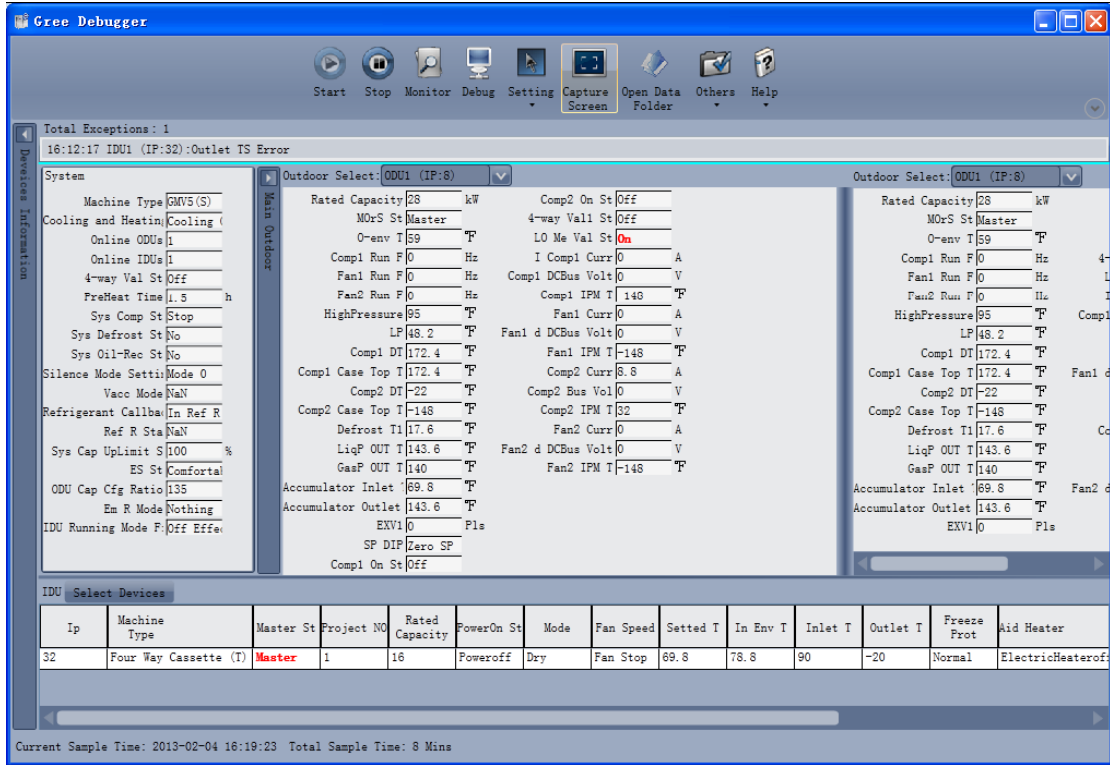

(2) Search for database folder.

Click icon of “Open Data Folder” on the menu bar to open database folder.

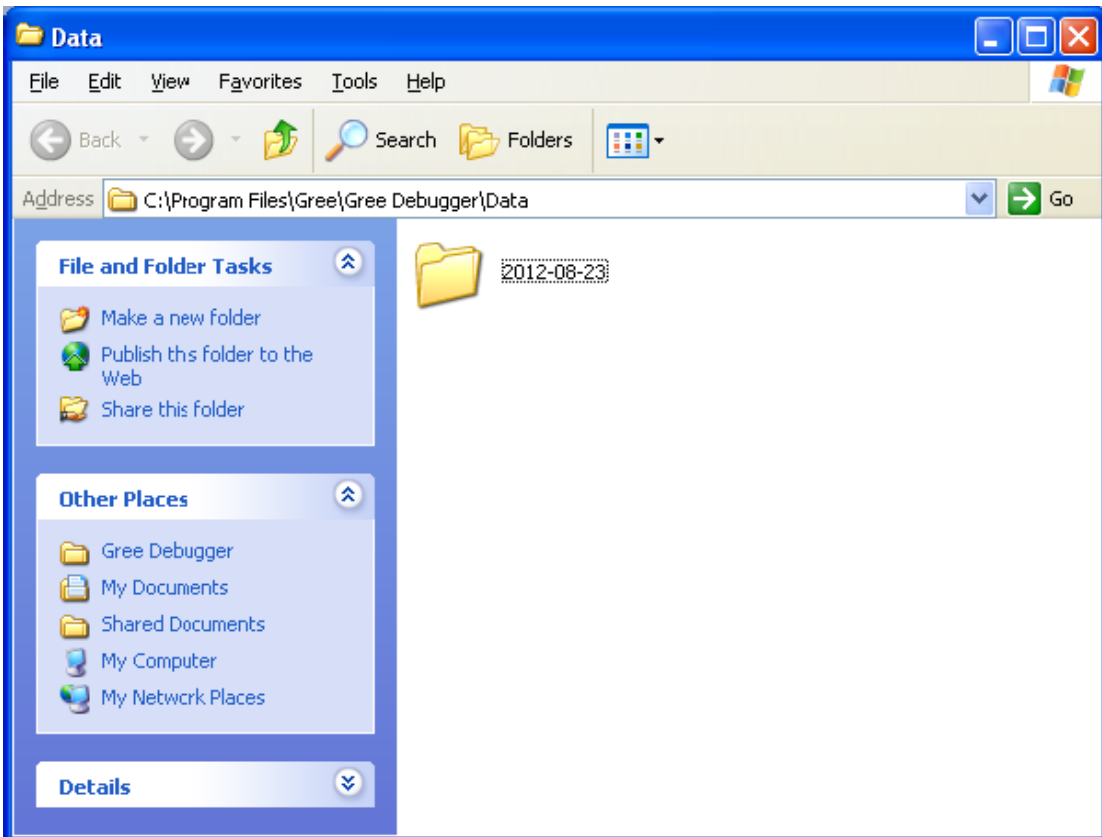
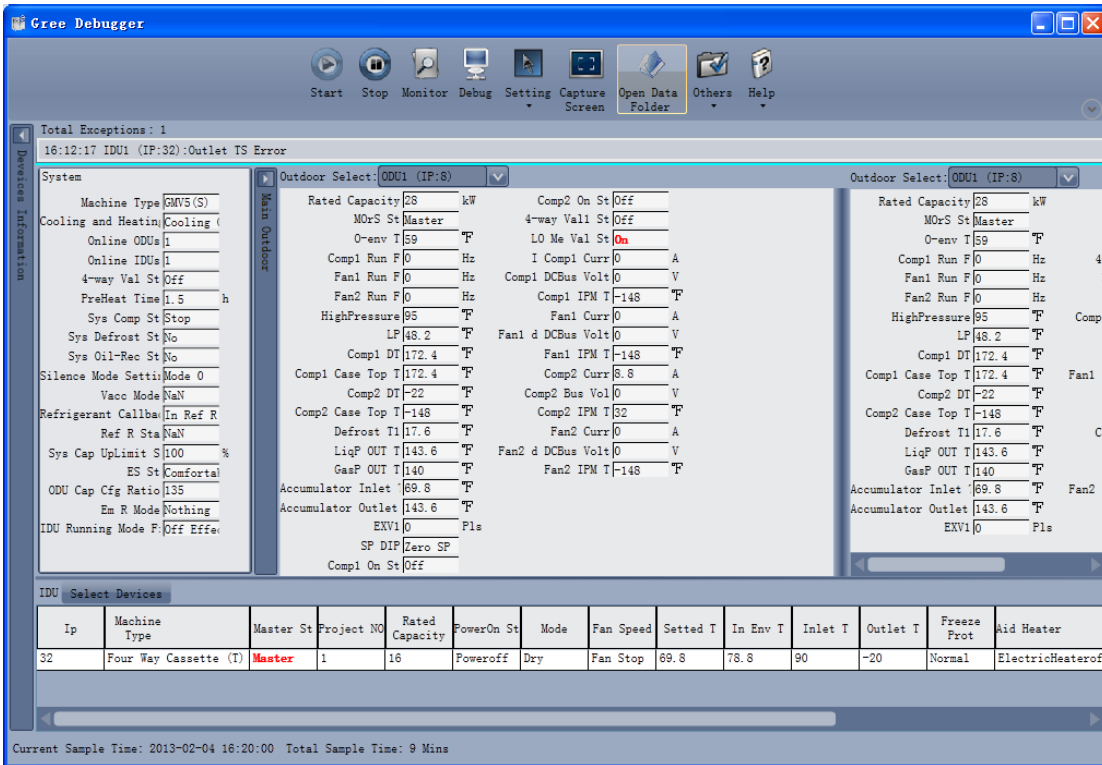

(3) Conversion of pressure value.

Click icon of “Others” on the menu bar and then click “Display Settings” to select “High Low Pressure Value” and “Refrigerant Type”. Select “Temperature” and the pressure parameter

displayed on the interface will be temperature. Select “Pressure” and the pressure parameter displayed on the pressure interface will be pressure. Refrigerant type will affect the pressure parameter displayed on the interface.

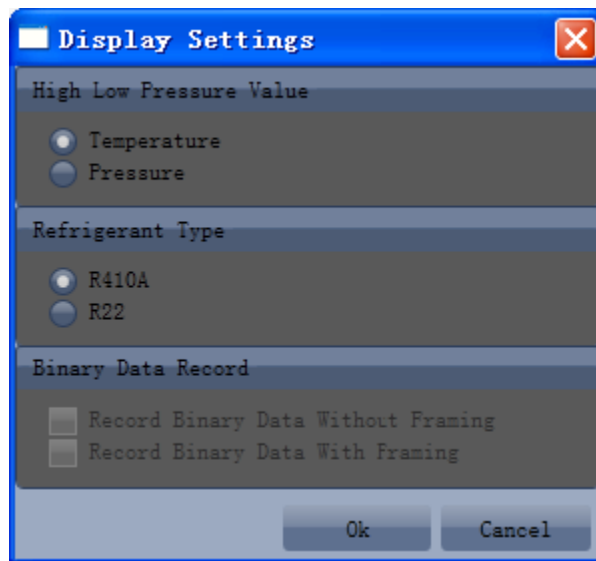
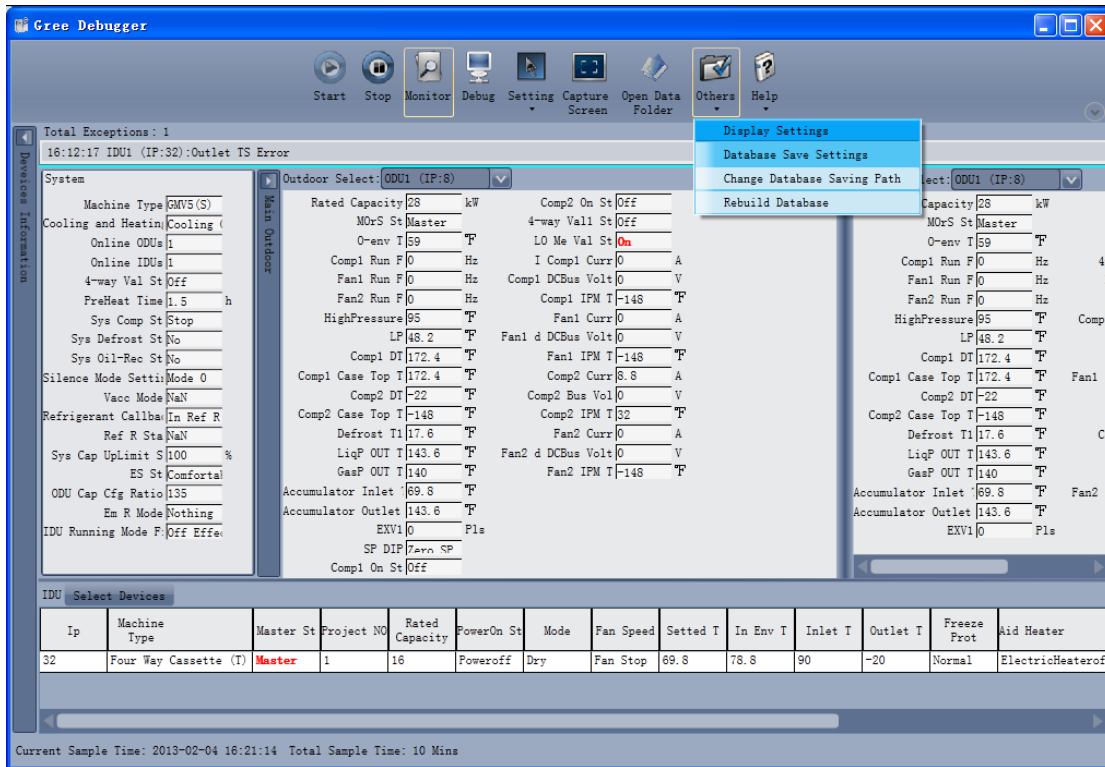

(4) Database saving of multiple systems.

Click icon of “Others” on the menu bar and click “Database Save Settings” to select which system that needs to save database. Because there is a large quantity of data in a network that contains multiple systems, data of only one system can be saved.

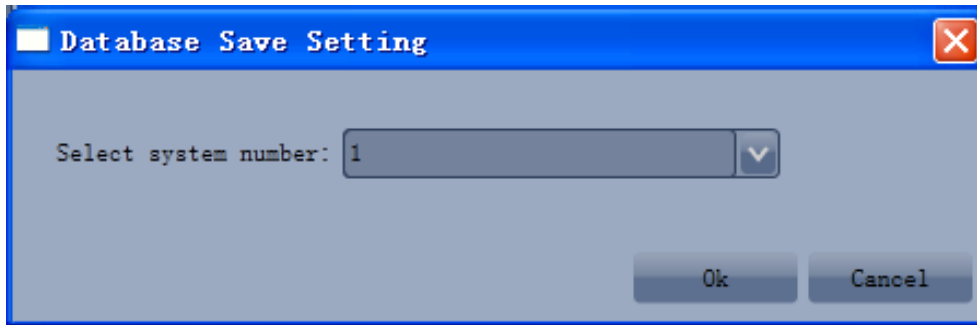
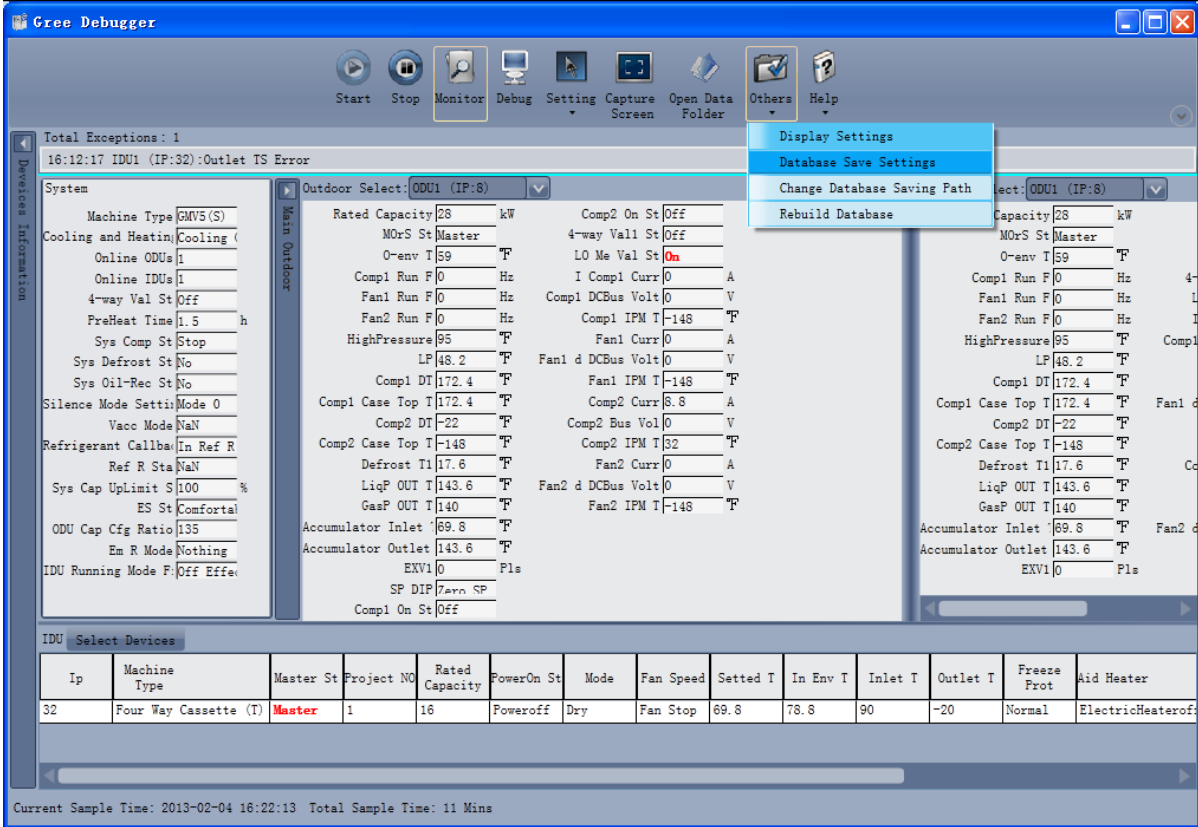

(5) Change database saving path and rebuild database.

Change of database saving path and rebuilding of database should be set before the software starts monitoring (see below interface). Click “Change database saving path” and click “Browse” to change the saving path. Click “Rebuild Database” to rebuild the database folder. You can also stop monitoring and turn back to the connection interface to change saving path or rebuild database during monitoring.

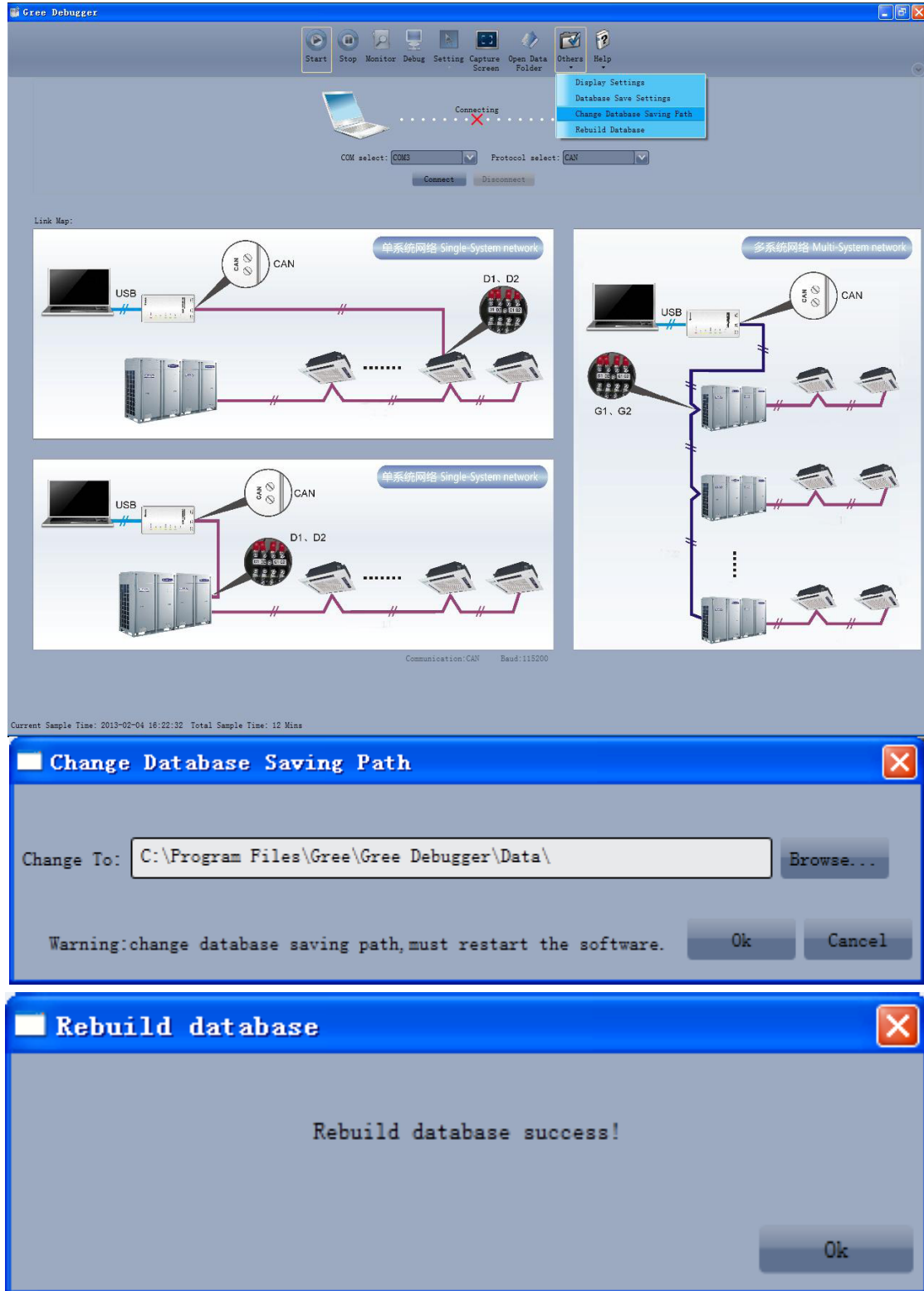

4.4.6 Usage of USB Converter

(1) Usage of converter.

Gree commissioning software should be connected with CAN interface when converter is used. For air conditioners with a single system, connect D1 and D2 interfaces of the wiring board. For air conditioners with multiple systems, connect G1 and G2 interfaces of the wiring board.

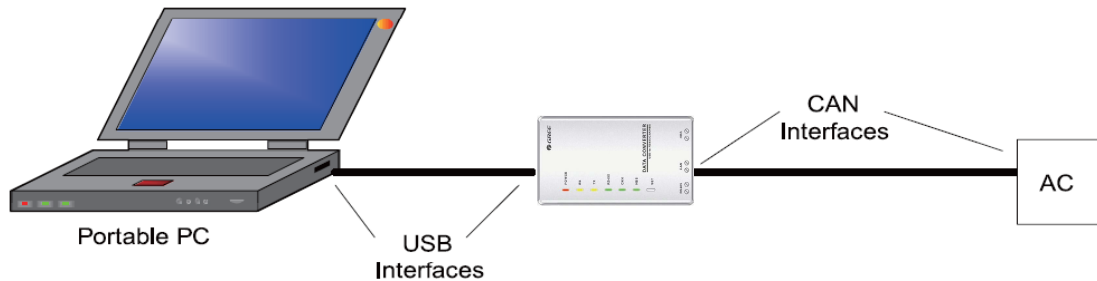

Gree monitoring software should be connected with RS485 interface when converter is used. Connect outdoor or indoor units or the mainboard of wired controller according to actual needs.

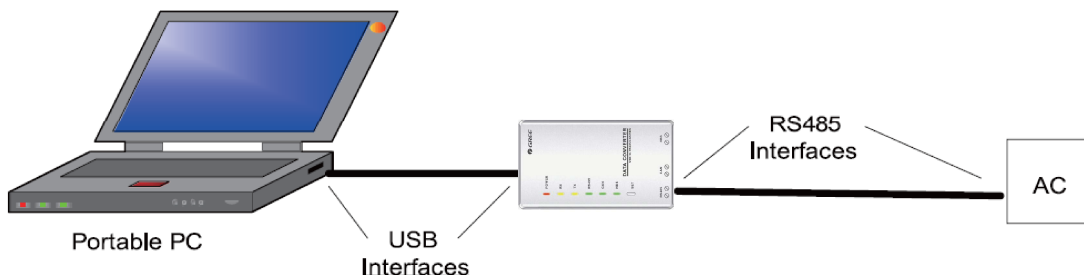

HBS, CAN and RS485 of the converter can be switched by buttons. Press the button “SET” on the converter to realize the conversion among HBS, CAN and RS485 interfaces. You can check the setting through the function LEDs.

NOTICES! If it's the first time your PC uses Gree USB data converter, in order to prevent Gree USB data converter from being mistaken by your computer as other devices and make sure your mouse can work well, it is necessary to turn off the Serail Enumerator of computer after Gree USB data converter is connected. Below are the steps:

Step 1: Right-click “My Computer” on the desktop and click “Manage”.

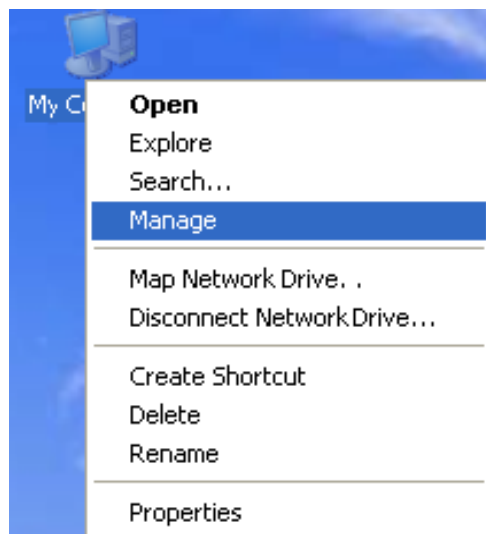

Step 2: In the pop-up window, select “Device Manager” in the left column and then find “Port (COM and LPT)” in the right column. Click its +!.

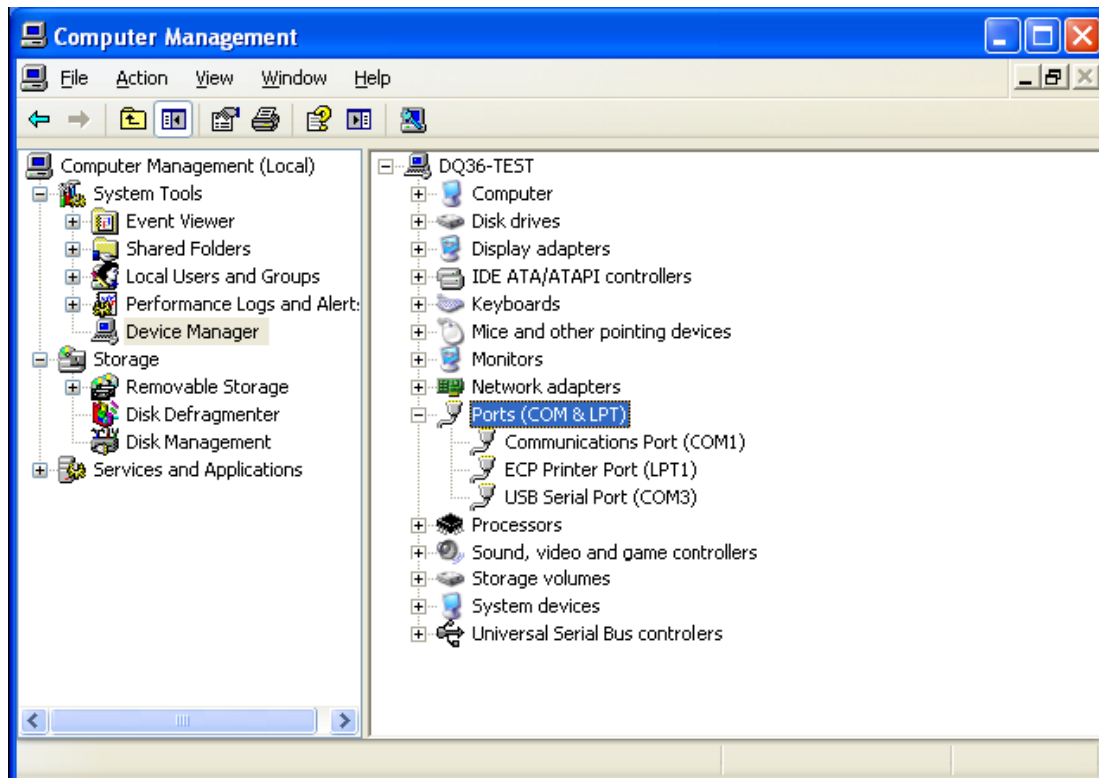
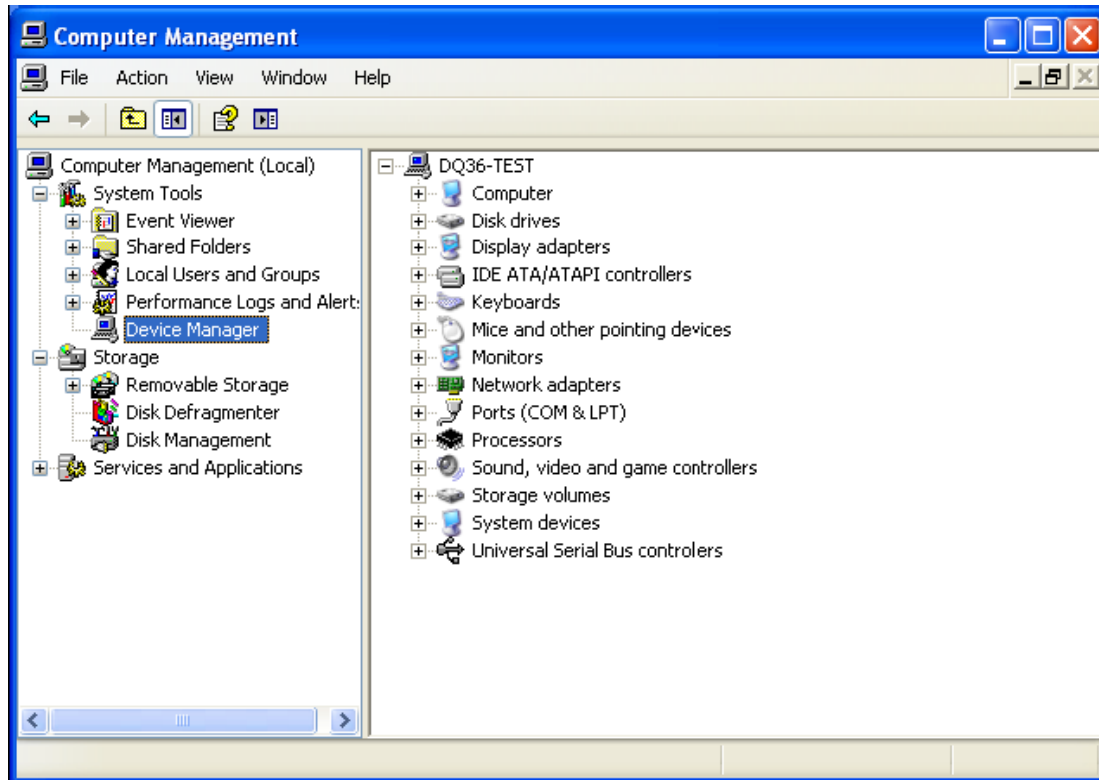

Step 4: Right-click “USB Serial Port (COM6)” and then click “Properties”. The dialog box of properties will then pop up.

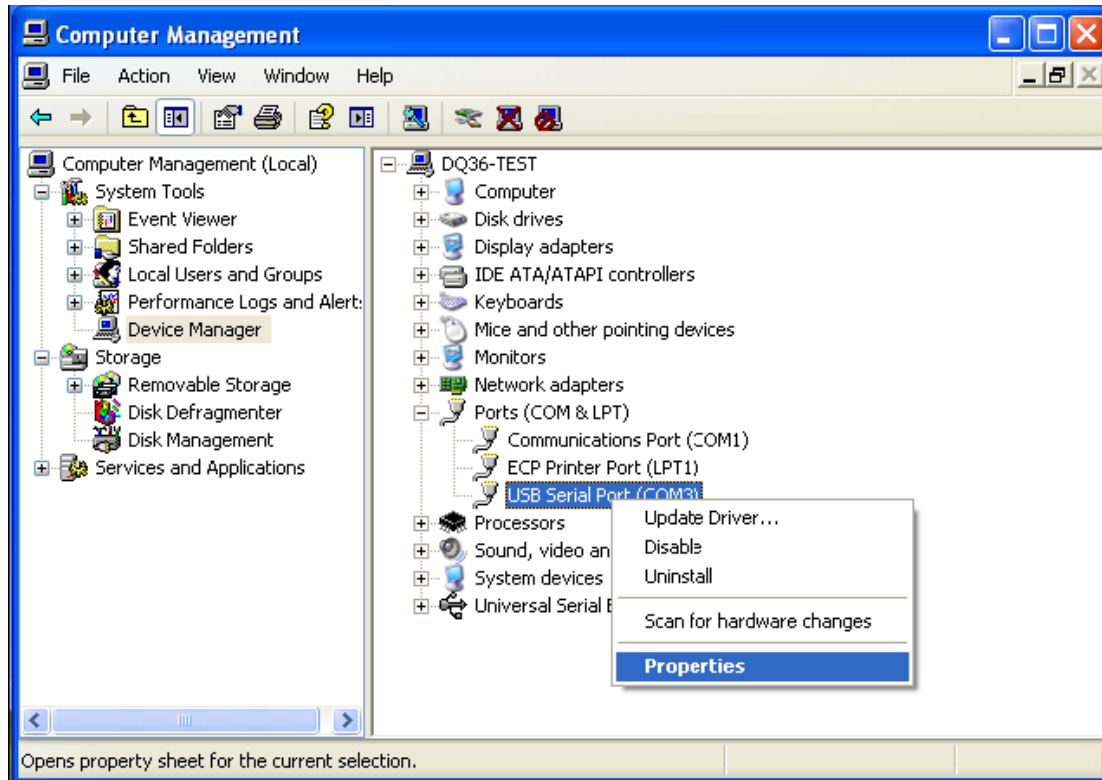

Step 5: Then click “Port Settings” in the dialog box.

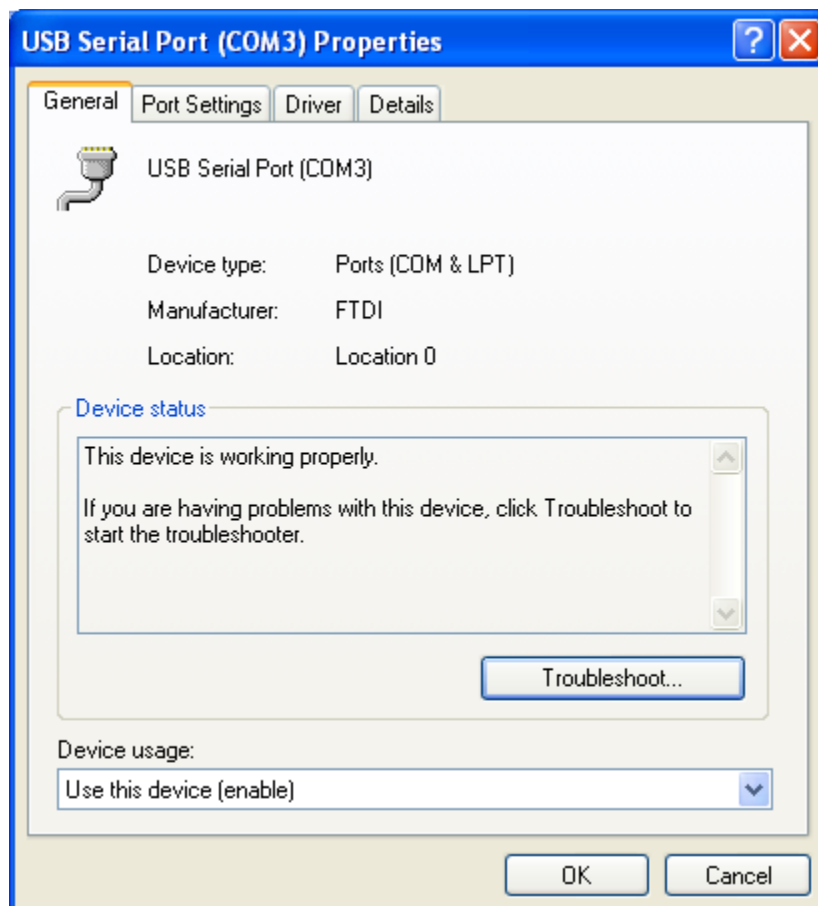

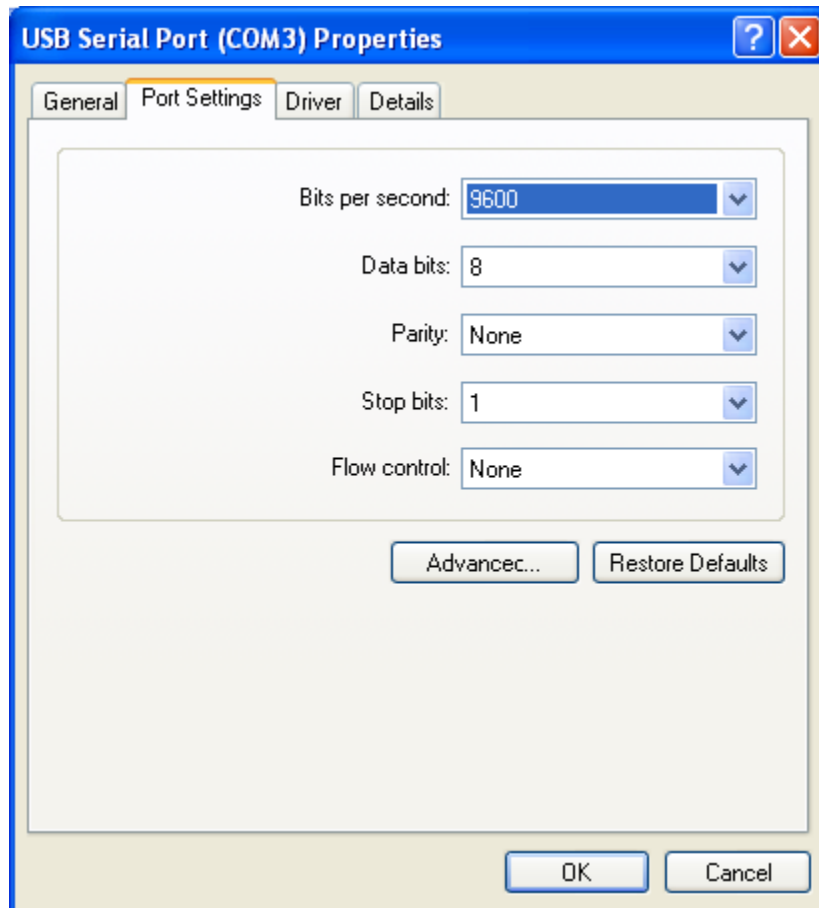

Step 6: Click “Advanced” and then a new dialog box will pop up. Find the “Serial Enumerator” in the miscellaneous options and cancel the tick. Click “OK” to exit.

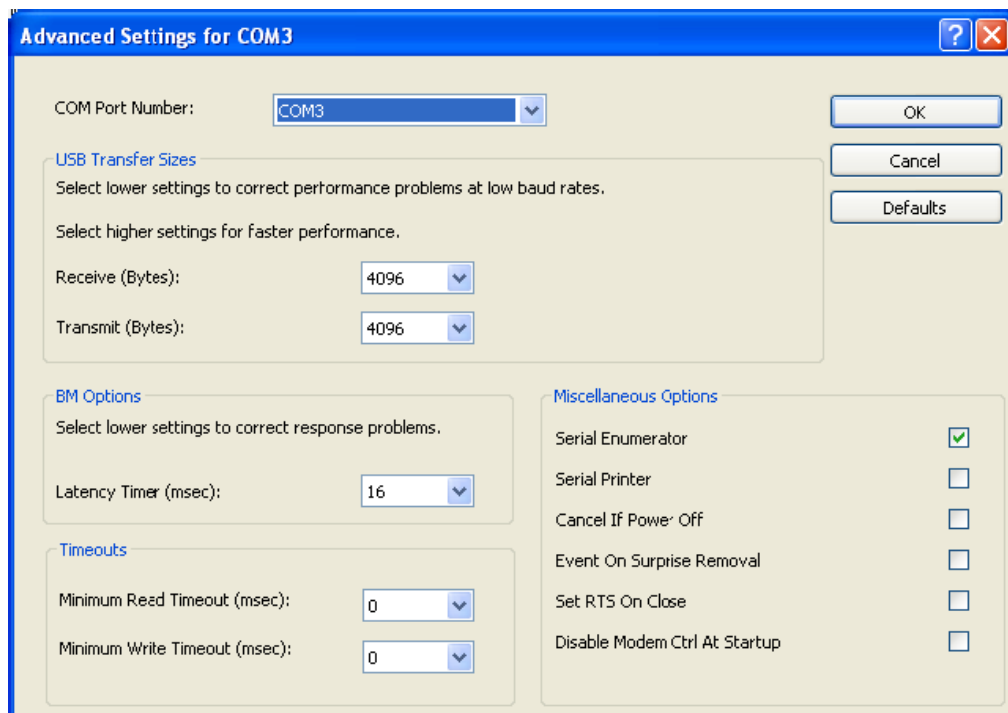

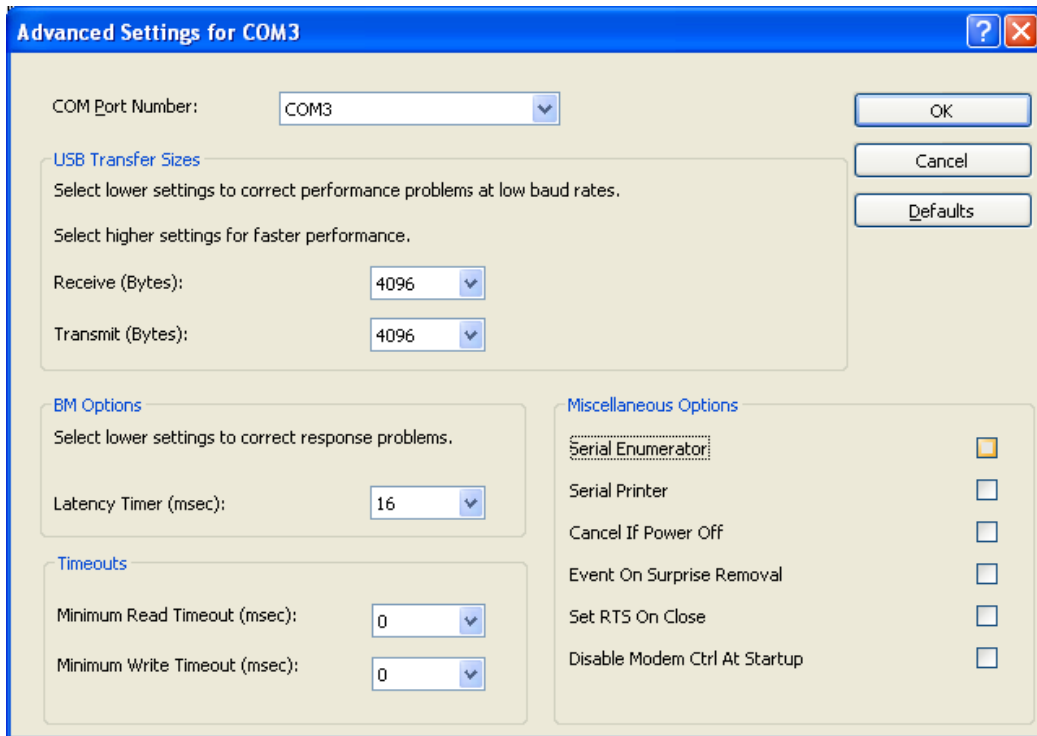

(2) Usage of converter configuring software:

When the converter is working, hold the button “SET” for 5 sec. Function LED will be flickering, indicating that the converter has enter the baud rate setting mode. Then you can use the converter configuring software to set the baud rate of converter. Baud rate supported by the converter (baud rate of air conditioner’s communication interface matches with the baud rate of USB interface automatically):

Ex-factory defaulted baud rate: (unit: bps)

AC is connected with	Baud rate of air conditioner interface	Baud rate of USB interface
CAN	20000/50000 self-adaptive	115200
HBS	57600	38400
RS485	9600	9600

Baud rate look-up table for RS485 interface (unit: bps)

RS485 interface	4800	9600	19200	38400	57600	115200
USB interface	4800	9600	19200	38400	57600	115200

Baud rate look-up table for HBS interface (unit: bps)

HBS interface	9600	19200	38400	57600
USB interface	4800	9600	19200	38400

Baud rate look-up table of CAN interface (unit: bps)

CAN interface	20000	50000	100000	125000
USB interface	115200	115200	256000	256000

Double-click the desktop shortcut.



Select the needed communication serial port and language in the “System Settings”.

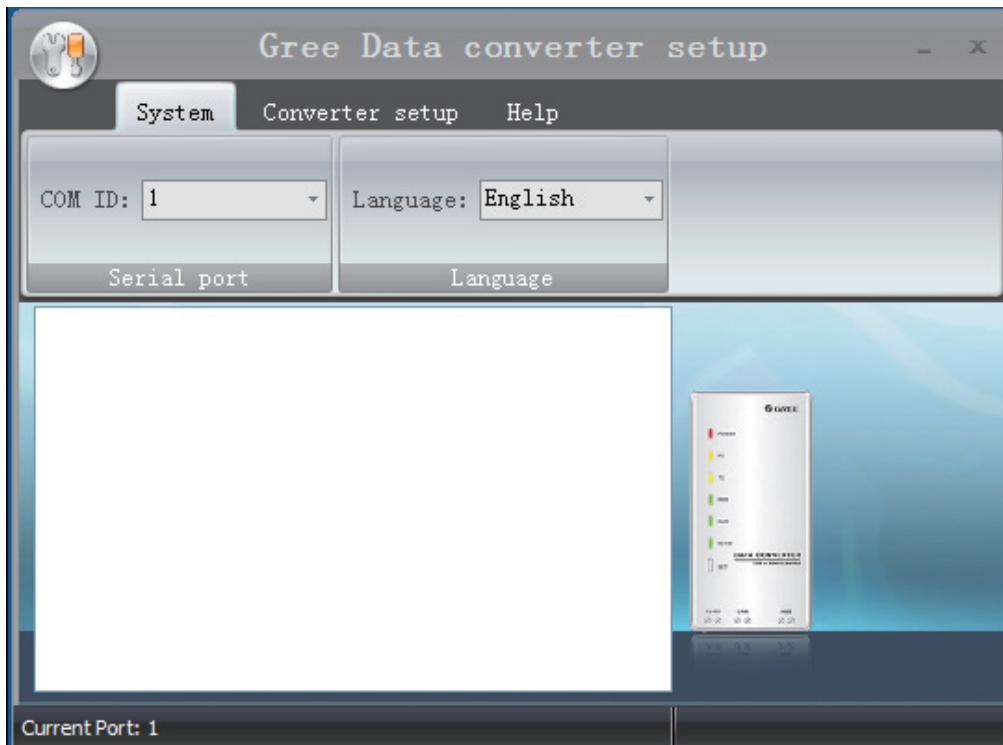

Select the function that is to be set and the corresponding baud rate (refer to the look-up table) in the “Converter Setup”. Then click “Set”.

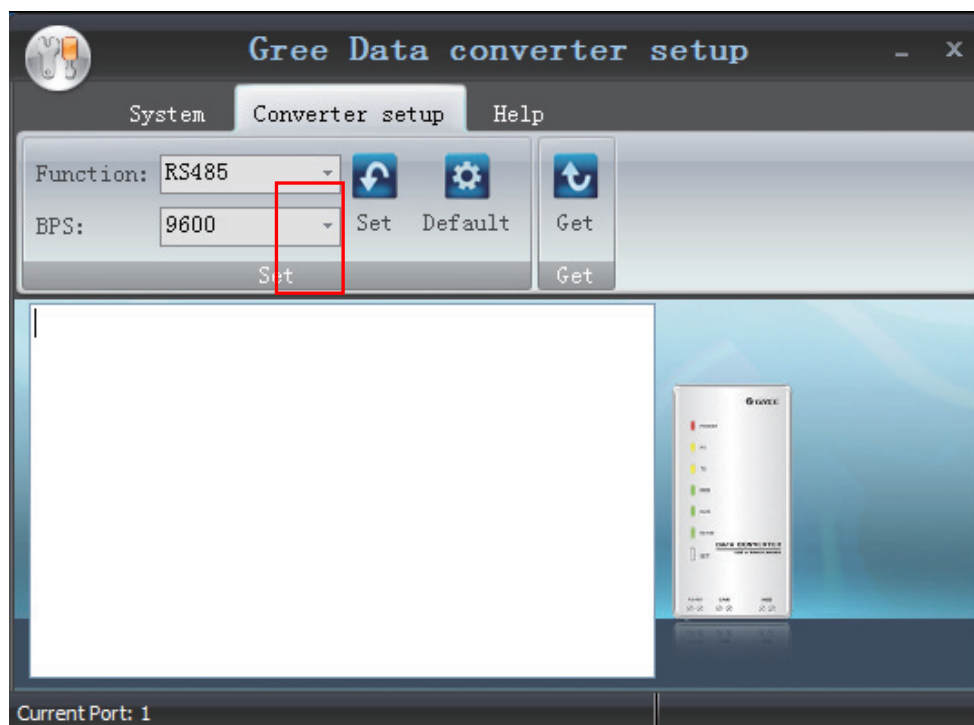

If you want to restore ex-factory settings, click “Default” to restore the default settings.

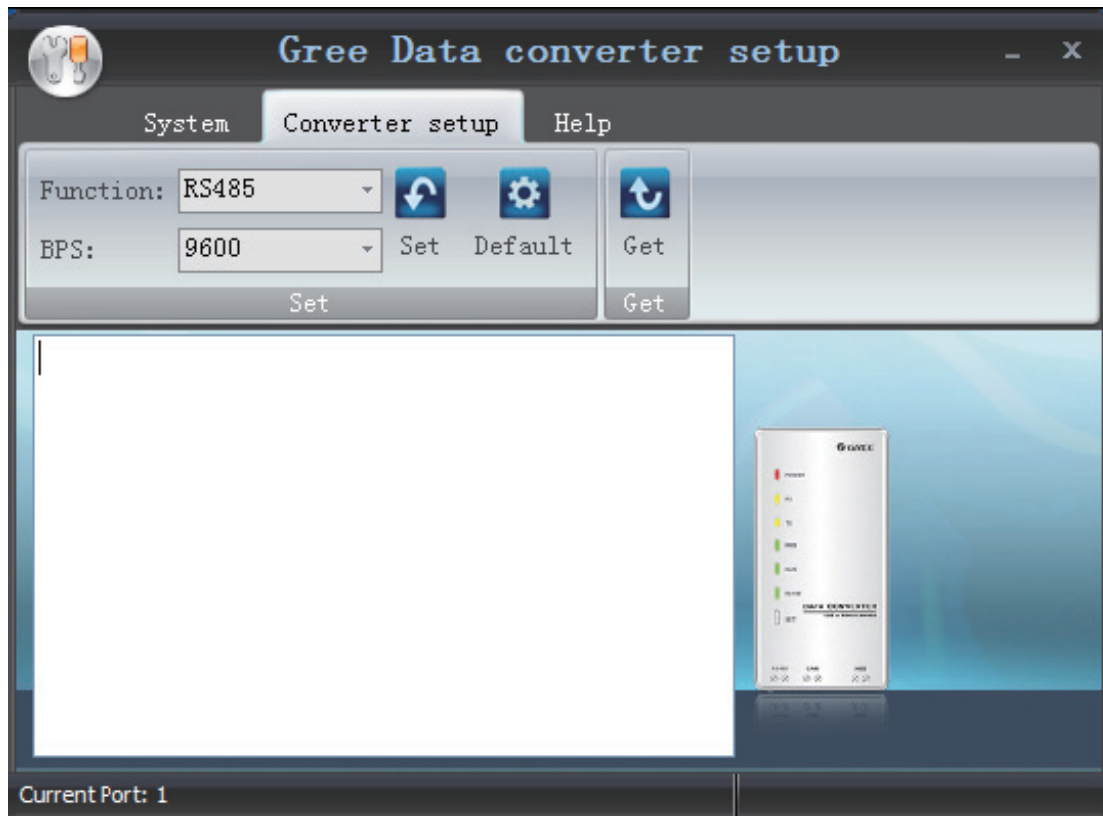

Click “Get” to get the current setting details of converter.

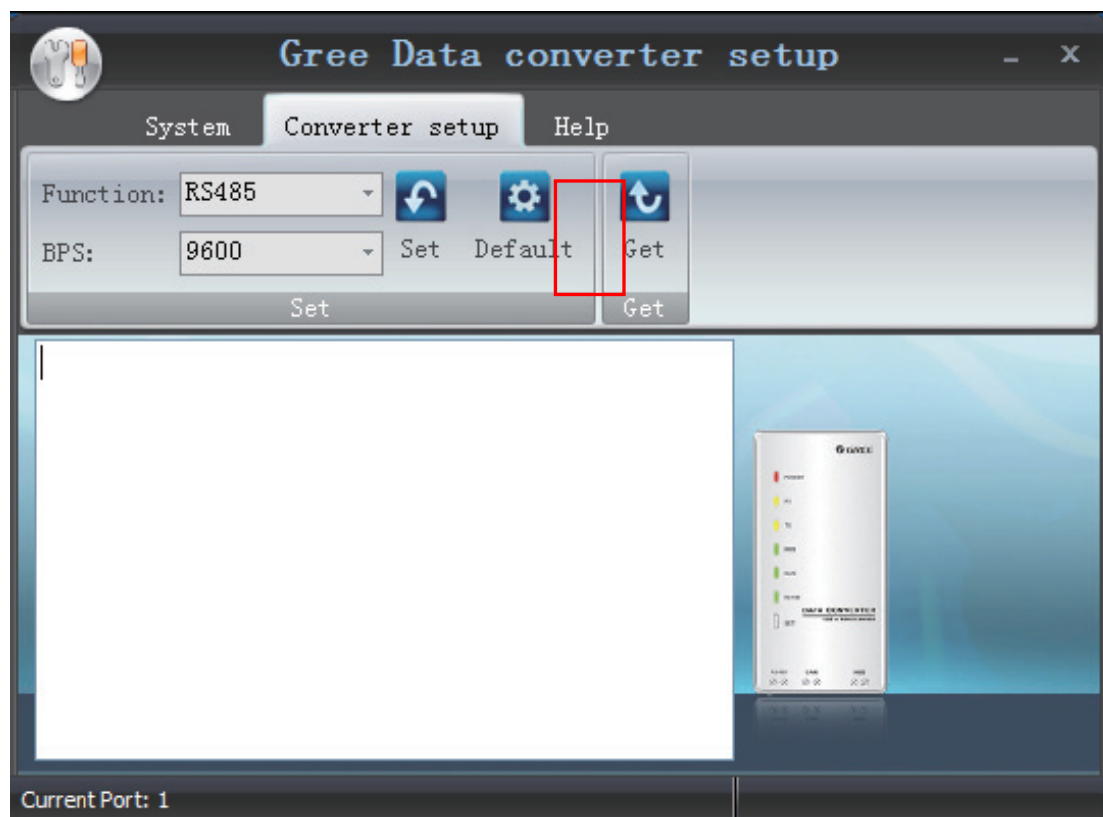

Switchover of Software Languages.

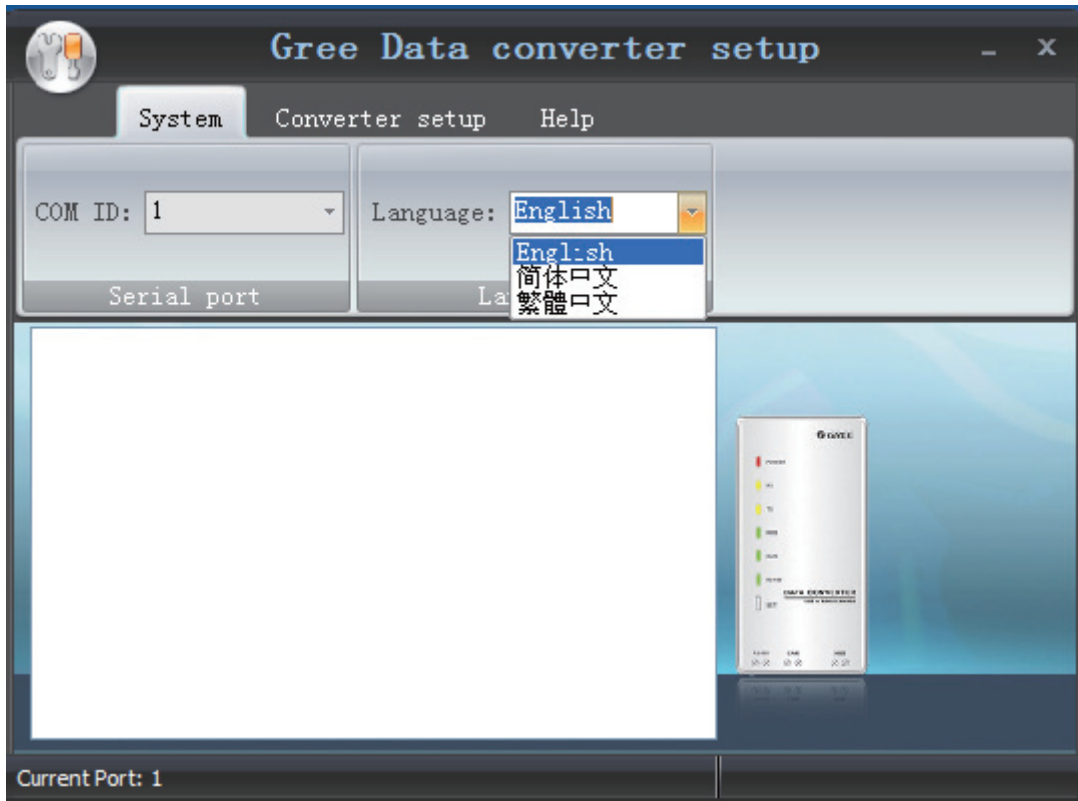

INSTALLATION

INSTALLATION

1 Engineering Installation Preparation and Notice

1.1 Installation Notice

Personnel and property safety are highly concerned during the entire installation process. Installation implementation must abide by relevant national safety regulations to ensure personnel and property safety.

All personnel involved in the installation must attend safety education courses and pass corresponding safety examinations before installation. Only qualified personnel can attend the installation. Relevant personnel must be held responsible for any violation of the regulation.

1.2 Installation Key Points and Importance

VRF air conditioning systems use refrigerant, instead of other agent, to directly evaporate to carry out the system heat. High level of pipe cleanness and dryness is required in the system. Since various pipes need to be prepared and laid out onsite, carelessness or maloperation during installation may leave impurities, water, or dust inside refrigerant pipes. If the design fails to meet the requirement, various problems may occur in the system or even lead to system breakdown.

Problems that usually occur during installation are as follows:

No.	Installation Problem	Possible Consequence
1	Dust or impurities enter into the refrigeration system.	Pipes are more likely to be blocked; air conditioning performance is reduced; compressor wear is increased or even hinder the normal operation of the system and burn the compressor.
2	Nitrogen is not filled into the refrigerant pipe or insufficient Nitrogen is filled before welding.	Pipes are more likely to be blocked; air conditioning performance is reduced; compressor wear is increased or even hinder the normal operation of the system and burn the compressor.
3	The vacuum degree in the refrigerant pipe is insufficient.	The refrigeration performance is reduced. The system fails to keep normal operation due to frequent protection measures. When the problem getting serious, compressor and other major components can be damaged.
4	Water enters into the refrigeration system.	Copper plating may appear on the compressor and reduce the compressor efficiency with abnormal noise generated; failures may occur in the system due to ice plug.
5	The refrigerant pipe specifications do not meet the configuration requirements.	Smaller configuration specifications can increase the system pipe resistance and affect the cooling performance; larger configuration specifications are waste of materials and can also reduce the cooling performance.
6	Refrigerant pipe is blocked.	The cooling performance is reduced; in certain cases, it may cause long-term compressor operating under overheat conditions; the lubricating effect can be affected and the compressor may be burnt if impurities were mixed with the lubricating oil.
7	Refrigerant pipe exceeds the limit.	The loss in pipe is considerable and the unit energy efficiency decreases, which are harmful for long-term running of the system.
8	Incorrect amount of refrigerant is filled.	The system cannot correctly control the flow allocation; the compressor may be operating under over-heating environment or running when the refrigerant flows back to the compressor.

No.	Installation Problem	Possible Consequence
9	The refrigerant pipe leaks.	Insufficient refrigerant circulating in the system decreases the cooling performance of the air conditioner. Long-term operation under such circumstance may cause an overheating compressor or even damage the compressor.
10	Water drainage from the condensate water pipe is not smooth.	Residual water in IDUs can affect the normal operation of the system. The possible water leakage can damage the IDU's decoration.
11	The ratio of slop for condensate water pipe is insufficient or the condensate water pipe is incorrectly connected.	Reverse slop or inconsistent connection of condensate water pipe can hinder the smooth drainage and cause leakage of the IDU.
12	The air channel is improperly fixed.	The air channel will deform; vibration and noise occur during unit operating.
13	The guide vane of air channel is not reasonably manufactured.	Uneven air quantity allocation reduces the overall performance of the air conditioner.
14	The refrigerant pipe or condensate water pipe does not meet the insulation requirement.	Water can easily condensate and drip to damage the indoor decoration, or even trigger the protection mode of system due to overheating operation.
15	The installation space for IDU is insufficient.	Since there is a lack of space for maintenance and checking, indoor decoration might need to be damaged during such operation.
16	The IDU or the location of the air outlet or return air inlet is not designed reasonably.	The air outlet or return air inlet may be short-circuited, thus affecting the air conditioning performance.
17	The ODU is improperly installed.	The ODU is difficult to be maintained; unit exhaust is not smooth, which reduces the heat exchanging performance or even prevent the system from normal operation; in addition, the cold and hot air for heat exchange and the noise may annoy people in surrounding areas.
18	Power cables are incorrectly provided.	Unit components may be damaged and potential safety hazard may occur.
19	Control communication cables are incorrectly provided or improperly connected.	The normal communication in the system fails or the control over IDUs and ODUs turn in a mess.
20	Control communication cables are not properly protected.	The communication cables are short-circuited or disconnected, and the unit cannot be started up due to communication failure.

Understand the special requirement (if any) for unit installation before implementation to ensure installation quality. Relevant installers must have corresponding engineering construction qualifications.

Special type operators involved in the engineering implementation, such as welders, electricians, and refrigeration mechanics must have relevant operating licenses and are accredited with vocational qualification certification.

2 Installation Materials Selection

The materials, equipment and instruments used during air conditioning engineering construction must have certifications and test reports. Products with fireproof requirements must be provided with fireproof inspection certificates and must meet national and relevant compulsory standards. If environmentally-friendly materials are to be used as required by customers, all such materials must meet national environmental protection requirement and be provided with relevant certificates.

2.1 Refrigerant Piping

- (1) Material requirement: Dephosphorization drawing copper pipe for air conditioners.
- (2) Appearance requirement: The inner and outer surface of pipe should be smooth without pinhole, crack, peeling, blister, inclusion, copper powder, carbon deposition, rust, dirt or severe oxide film, and without obvious scratch, pit, spot and other defects.
- (3) Test report: Certifications and quality test reports must be provided.
- (4) The tensile strength must be at least 240 kgf/mm².
- (5) Specifications requirement.

R410A Refrigerant System		
OD (mm/inch)	Wall Thickness (mm/inch)	Model
Φ6.35(1/4)	≥0.8(1/32)	0
Φ9.52(3/8)	≥0.8(1/32)	0
Φ12.70(1/2)	≥0.8(1/32)	0
Φ15.9(5/8)	≥1.0(1/25)	0
Φ19.05(3/4)	≥1.0(1/25)	0

- (6) After the inner part of the copper pipe is cleaned and dried, the inlet and outlet must be sealed tightly by using pipe caps, plugs or adhesive tapes.

2.2 Condensate Water Pipe

- (1) Pipes that can be used for air conditioner drainage include: water supplying UPVC pipe, PP-R pipe, PP-C pipe, and HDG steel pipe.
- (2) All relevant certificates and quality test reports are provided.
- (3) Requirements for specifications and wall thickness.
- (4) Water supplying UPVC pipe: Φ15mm×2mm(9/16inch×1/16inch), Φ32mm×2mm(1-4/16inch×1/16inch), Φ40mm×2mm(1-9/16inch×1/16inch), Φ50mm×2.5mm(1-15/16inch×2/16inch).
- (5) HDG steel pipe: Φ25mm×3.25mm(1inch×2/16inch), Φ32mm×3.25mm(1-4/16inch×2/16inch), Φ40mm×3.5mm(1-9/16inch×2/16inch), Φ50mm×3.5mm(1-15/16inch×2/16inch).

2.3 Insulation Material

- (1) Rubber foam insulation material.
- (2) Flame retardancy level: B1 or higher.
- (3) Refractoriness: at least 120°C(248°F).
- (4) The insulation thickness of condensate water pipe: at least 10mm (3/8 inch).
- (5) When the diameter of copper pipe is equal to or greater than Φ15.9mm (3/4inch), the thickness of insulation material should be at least 20mm (13/16inch); when the diameter of copper pipe is less than 15.9mm (3/4 inch), the thickness of insulation material should be at least 15mm (9/16 inch).

2.4 Communication Cable and Control Cable

NOTICE! For air conditioning units installed in places with strong electromagnetic interference, shielded wire must be used as the communication cables of the IDU and wired controller, and shielded twisted pairs must be used as the communication cables between IDUs and between the IDU and ODU.

Communication cable selection for ODU and IDUs

Material Type	Total Length of Communication Cable between IDU Unit and IDU (ODU) Unit L(m/feet)	Wire size	Remarks
Light/Ordinary polyvinyl chloride sheathed cord.	$L \leq 1000(3280-5/6)$	$\geq 2 \times \text{AWG}18$	(1) If the wire diameter is enlarged to $2 \times \text{AWG}16$, the total communication line length can reach 1500 m (4921-1/4feet). (2) The cord shall be Circular cord (the cores shall be twisted together). (3) If unit is installed in places with intense magnetic field or strong interference, it is necessary to use shielded wire.

2.5 Power Cable

Only copper conductors can be used as power cables. The copper conductors must meet relevant national standard and satisfy the carrying capacity of unit.

2.6 Hanger Rod and Support

- (1) Hanger rod: M8 or M10.
- (2) U-steel: 14# or above.
- (3) Angle steel: 30mm×30mm×3mm(1-3/16inch×1-3/16inch×2/16inch) or above.
- (4) Round steel: $\Phi 10\text{mm}$ (3/8 inch) or above.

3 Installation of Outdoor Unit

3.1 Check before Installation

- (1) Before installation, please check the power cord if it complies with the power supply requirement on the nameplate. Make sure the power supply is safe.
- (2) This air conditioner must be properly grounded through the receptacle to avoid electric shock. The ground wire shouldn't be connected with gas pipe, water pipe, lightning arrester or telephone line.
- (3) Maintain good air circulation to avoid lacking oxygen.
- (4) Read this manual carefully before installation.

3.2 Selection of Installation Site

- (1) Select a location which is strong enough to hold unit's weight so that unit can stand still and erect.
- (2) Make sure the unit is not exposed to sun and rain. And the location can resist dust,

typhoon and earthquake.

- (3) Please keep the unit away from inflammable, explosive and corrosive gas or waste gas.
- (4) Make sure the location has space for heat exchange and maintenance so that unit can operate reliably with good ventilation.
- (5) ODU and IDU should stay as close as possible to shorten the length of refrigerant pipe and reduce bend angles.
- (6) Select a location which is out of children's reach. Keep the unit away from children.

3.3 Carrying and Installing Outdoor Unit

When carrying the outdoor unit, hang the unit in four directions with two sufficient ropes. In order to avoid excursion from the center, the angel of ropes must be smaller than 40° during hanging and moving.

3.4 Installation Notices

In order to ensure proper operation, the selection of installation site must conform to the following principle:

- (1) The discharged air of outdoor unit will not flow back and there is sufficient space around the unit for maintenance.
- (2) The installation site must be well ventilated to ensure sufficient air intake and discharge. Make sure there is no obstacle at the air inlet and air outlet. If there is any obstacle, please remove it.
- (3) The installation site shall be able to withstand the weight of outdoor unit and capable for soundproof and vibration. The air outlet and noise of unit will not affect neighbors.
- (4) The hanging of outdoor unit must use appointed hanging hole. Pay attention to protect the unit during hanging and installation. Prohibit hitting the sheet metal to avoid rust in the future.
- (5) Avoid direct sunlight.
- (6) The rain and condensation water can be drained out smoothly.
- (7) The outdoor unit will not be embedded by the snow and not affected by garbage and oil smog.
- (8) The installation of outdoor unit shall adopt rubber damping pad or spring damper to reduce noise and vibration.
- (9) The installation dimension shall accord with the installation requirement of this manual and the outdoor unit must be fixed at the installation site.
- (10) The installation shall be done by professional technicians.

3.5 Fixing and Damping of Unit

The outdoor unit shall be fixed with 4 M12 bolts and closely contacted with the foundation. Otherwise, big vibration and noise will be caused.

The outdoor unit shall be fixed firmly. The rubber board with thickness over 20mm(13/16inch)

or corrugated rubber damping pad shall be applied between the unit and foundation.

3.6 Outline Dimension and Position of Installation Hole

When carrying the outdoor unit, hang the unit in four directions with two sufficient ropes. In order to avoid excursion from the center, the angel of ropes must be smaller than 40° during hanging and moving.

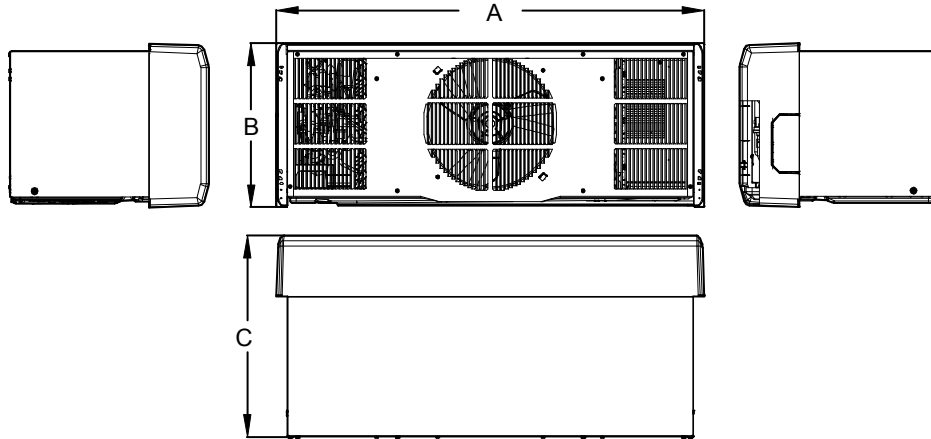

Unit: mm (inch)

Model	A	B	C
GMV-12WP/A-T(U)	1069 (42-1/16)	406 (16)	500 (19-11/16)

3.7 Installation Space Requirement

If all sides of the ODU (including the top) are surrounded by walls, process according to the following requirements for installation space.

GMV-12WP/A-T(U):

Unit: mm (inch)

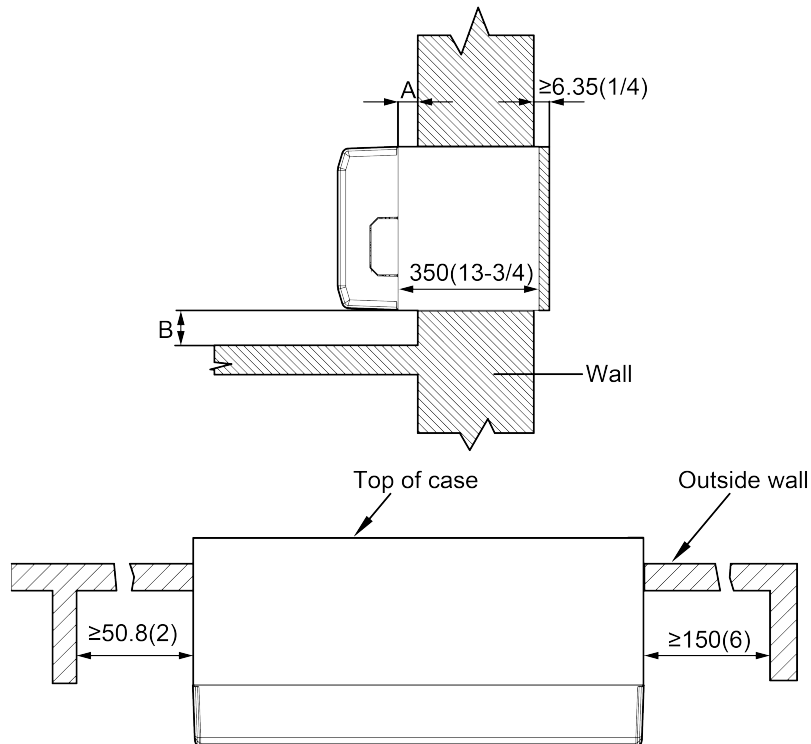

Dimension	A	B	
	Allow for wall finishing	Allow for floor finishing	
	Min.(mm/inch)	Min. (mm/inch)	Max(mm/inch)
No Accessories	6.35(1/4)	6.35(1/4)	—
With Subbase	45(1-3/4)	89(3-1/2)	127(5)
With Lateral Duct	19(3/4)	6.35(1/4)	—

NOTICE	
(1)	If more than one accessory is to be used, use the maximum dimension. If the wall thickness is more than 350mm(13-3/4in.) - (A +6.35mm(1/4in.)), a sleeve extension must be used.
(2)	See the manual for detailed installation instructions.

4 Installation of Electronic Expansion Valve Assy (unit with external EXV)

The EXV of indoor unit is built-in.

5 Installation of Refrigerant Pipeline

5.1 Allowable Length and Height Difference of Connection Pipe

Y type branch joint is adopted to connect indoor and outdoor units. Connecting method is shown in the figure below:

NOTICE! Equivalent length of one Y-type branch is 0.5m(1-5/8feet).

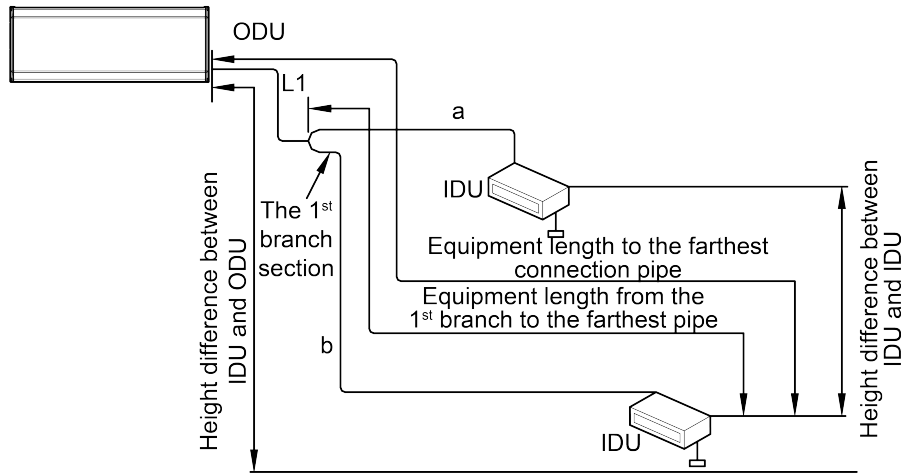

Each Y-type branch equals to 0.5m(1-5/8feet) and each branch header equals to 1.0m(3-1/4feet).

Allowable Length and Height Difference of Connection Pipe.

Piping parameters of GMV-12WP/A-T(U):

—	Allowable value		Fitting pipe
	m	feet	
Total length (actual length) of fitting pipe	30	98-3/8	L1+a+b
Length of farthest fitting pipe (m)	Actual length	30	98-3/8
	Equivalent length	30.5	100-1/8
From the 1 st branch to the farthest indoor pipe	15	49-2/8	b
Height difference between ODU and IDU	ODU at upper side	15	49-2/8
	ODU at lower side	15	49-2/8
Height difference between IDUs	10	32-6/8	—

5.2 Dimension of Pipe (Main Pipe) from ODU to the 1st Indoor Branch

Dimension of pipe from ODU to the 1st indoor branch will be determined by the dimension of outdoor connection pipe.

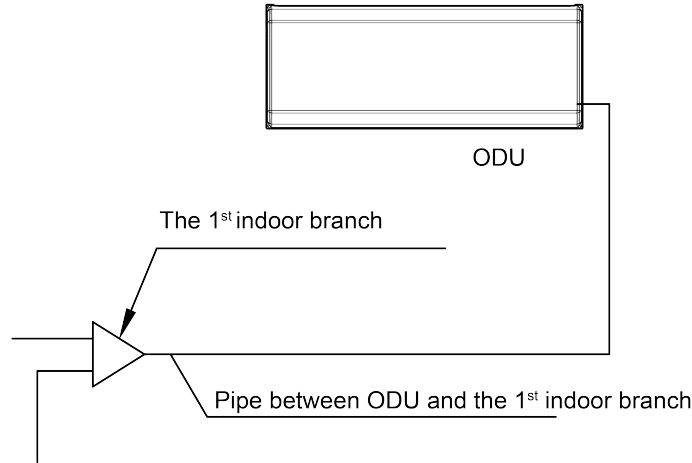

Dimension of outdoor connection pipe:

Basic module	Pipe dimension		Connection method
	Gas pipe (mm/inch)	Liquid pipe (mm/inch)	
GMV-12WP/A-T(U)	Φ12.7 (Φ1/2)	Φ6.35 (Φ1/4)	

5.3 Selection of Indoor Branches

Select indoor branches according to the total capacity of downstream indoor units. if the capacity exceeds that of the outdoor unit, capacity of outdoor unit prevails.

GMV-12WP/A-T(U):

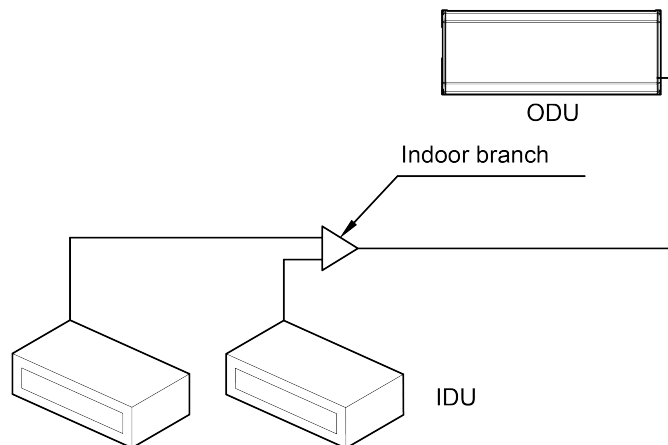

Refrigerant system	Total capacity of downstream indoor units C (Btu/h)	Model
Y type branch	$C < 68200$	FQ01A/A
	$68200 \leq C \leq 102400$	FQ01B/A
	$102400 < C \leq 238800$	FQ02/A
	$238800 < C \leq 460600$	FQ03/A
	$460600 < C$	FQ04/A

5.4 Dimension of Pipe between Indoor Branches

Select pipe between indoor branches according to the capacity of downstream indoor units; if the capacity exceeds that of the outdoor unit, capacity of outdoor unit prevails.

GMV-12WP/A-T(U):

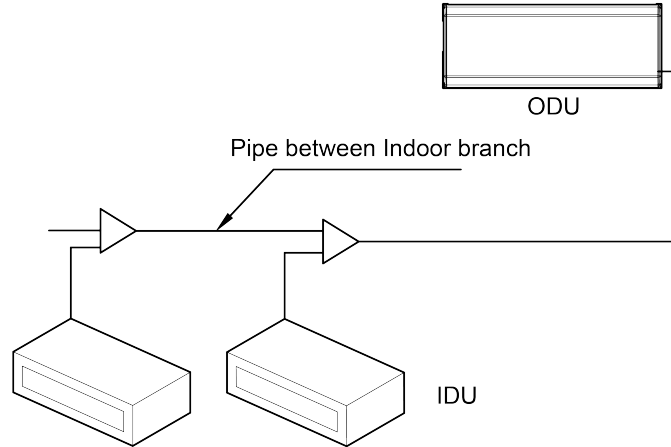

Total capacity of downstream indoor units C (Btu/h)	Pipe (mm/inch)	Liquid pipe (mm/inch)
$C \leq 19000$	$\Phi 12.7$ ($\Phi 1/2$)	$\Phi 6.35$ ($\Phi 1/4$)
$19000 < C \leq 48500$	$\Phi 15.9$ ($\Phi 5/8$)	$\Phi 9.52$ ($\Phi 3/8$)
$48500 < C \leq 76400$	$\Phi 19.05$ ($\Phi 3/4$)	$\Phi 9.52$ ($\Phi 3/8$)

5.5 Dimension of Pipe between Indoor Branch and IDU

Dimension of pipe between indoor branch and IDU should be consistent with the dimension of indoor pipe.

GMV-12WP/A-T(U):

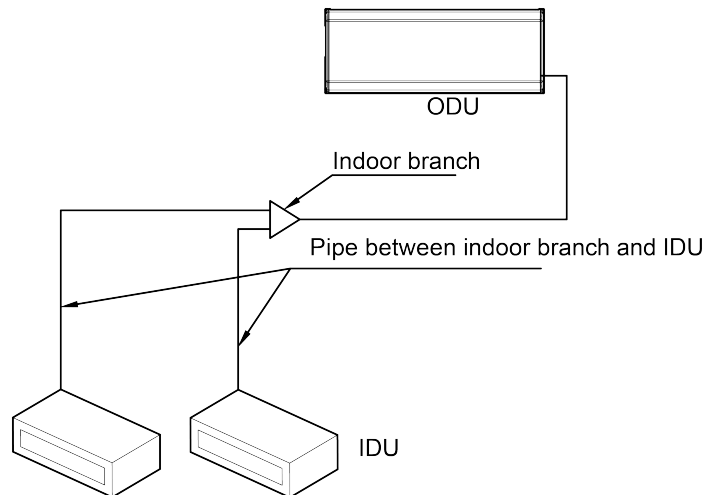

Rated capacity of IDU C(Btu/h)	Gas pipe (mm/inch)	Liquid pipe (mm/inch)
$C \leq 9600$	$\Phi 9.52$ ($\Phi 3/8$)	$\Phi 6.35$ ($\Phi 1/4$)
$9600 < C \leq 17000$	$\Phi 12.7$ ($\Phi 1/2$)	$\Phi 6.35$ ($\Phi 1/4$)
$17000 < C \leq 48000$	$\Phi 15.9$ ($\Phi 5/8$)	$\Phi 9.52$ ($\Phi 3/8$)

Rated capacity of IDU C(Btu/h)	Gas pipe (mm/inch)	Liquid pipe (mm/inch)
48000<C≤55000	Φ19.05 (Φ3/4)	Φ9.52 (Φ3/8)
55000<C≤96000	Φ22.2 (Φ7/8)	Φ9.52 (Φ3/8)

NOTICE! If the distance between IDU and its nearest branch is over 10m(33feet), then the liquid pipe of IDU (rated capacity ≤17000Btu/h) shall be enlarged.

6 Installation of Connection Pipe

⚠ CAUTION

- (1) Conform to the following principles during pipe connection: Connection pipe should be as short as possible, so is the height difference between indoor and outdoor units. Keep the number of bends as little as possible. Radius of curvature should be as large as possible.
- (2) Weld the connection pipe between indoor and outdoor units. Please strictly follow the requirements for welding process. Rosin joint or pin hole is not allowed.
- (3) When laying the pipe, be careful not to distort it. Radius of bending parts should be over 200mm(8inch). Note that pipes cannot be repeatedly bent or stretched; otherwise the material will get harder. Do not bend or stretch the pipe for more than 3 times at the same position.

6.1 Flaring Process

- (1) Use pipe cutter to cut the connection pipe in case it is unshaped.
- (2) Keep the pipe downward in case cutting scraps get into the pipe. Clear away the burrs after cutting.
- (3) Remove the flared nut connecting indoor connection pipe and outdoor unit. Then use flaring tool to fix the flared nut into the pipe (as shown in Fig.10).
- (4) Check if the flared part is flaring evenly and if there is any crack.

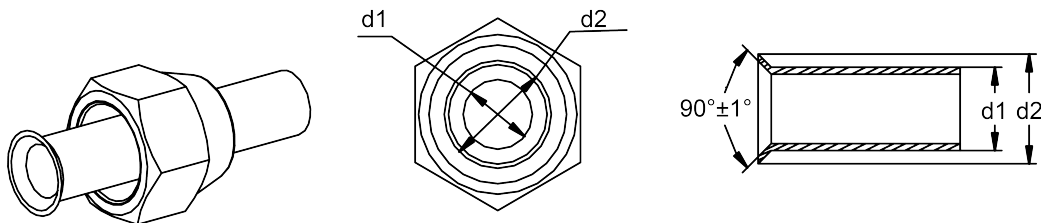
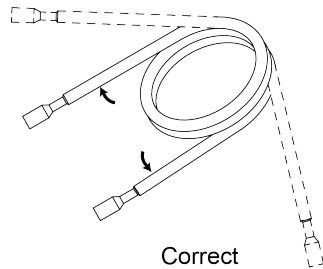

Fig. 10

6.1.1 Pipe Bending

- (1) Reshape the pipe by hand. Be careful not to damage the pipe.
- (2) Do not bend the pipe over 90°.
- (3) (If pipe is repeatedly bent or stretched, it will get hard and difficult to bend and stretch again. Therefore, do not bend or stretch the bend for over 3 times.

- (4) In case that direct bending will open cracks to the pipe, first use sharp cutter to cut the insulating layer, as shown in Fig. 12. Do not bend the pipe until it is exposed. When bending is done, wrap the pipe with insulating layer and then secure it with adhesive tape.



Correct

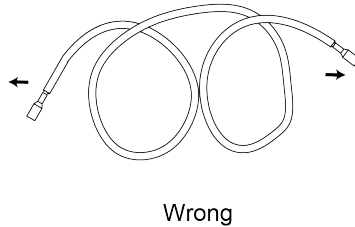

Wrong

Fig. 11

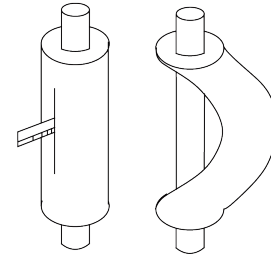

Fig. 12

6.1.2 Indoor Pipe Connection

- (1) Remove pipe cover and pipe plug.
- (2) Direct the flared part of copper pipe to the center of screwed joint. Twist on the flared nut tightly by hand, as in Fig. 13. (Make sure indoor pipe is correctly connected. Improper location of the center will prevent flared nut from being securely twisted. Thread of nut will get damaged if the flared nut is twisted forcibly).
- (3) Use torque wrench to twist on the flared nut tightly until the wrench gives out a click sound. (Hold the handle of wrench and make it at right angle to the pipe. as in Fig. 14

CAUTION
(1) Use sponge to wrap the un-insulated connection pipe and joint. Then tie the sponge tightly with plastic tape.
(2) Connection pipe should be supported by a bearer rather than the unit.
(3) The bending angle of piping should not be too small; otherwise the piping might have cracks. Please use a pipe bender to bend the pipe.
(4) When connecting IDU with connection pipe, do not pull the big and small joints of IDU with force in case the capillary tube or other tubes have cracks and cause leakage.

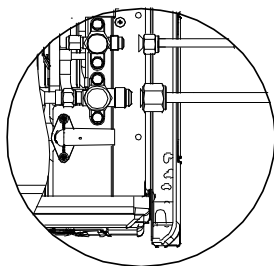

Fig. 13

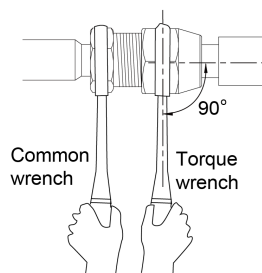

Fig. 14

Pipe Diameter	Tightening Torque
Φ6.35mm(1/4 inch)	15~30(N·m)
Φ9.52mm(3/8 inch)	35~40(N·m)
Φ12.7mm(1/2 inch)	45~50(N·m)
Φ15.9mm(5/8 inch)	60~65(N·m)

6.1.3 Outdoor Pipe Connection

Twist the flared nut on the connection pipe of outdoor valves. Twisting method is the same as for indoor pipe connection.

During engineering installation, the connection pipe inside the unit must be wrapped by insulation sleeve.

Below is the piping diagram of GMV-12WP/A-T(U). According to customer requirement or space limit, outlet pipe can be installed from the front, right or rear side.

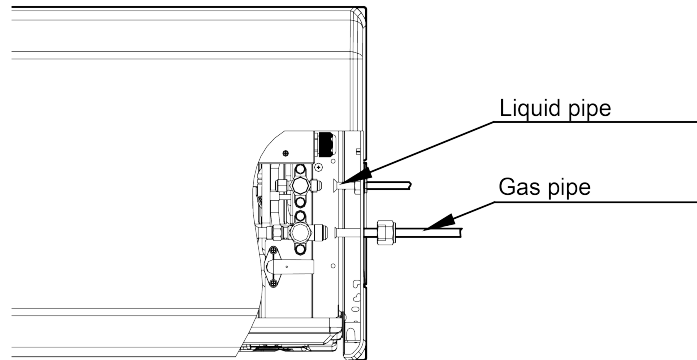

6.1.4 Installation of Y-type Branch

(1) Y-type Branch.

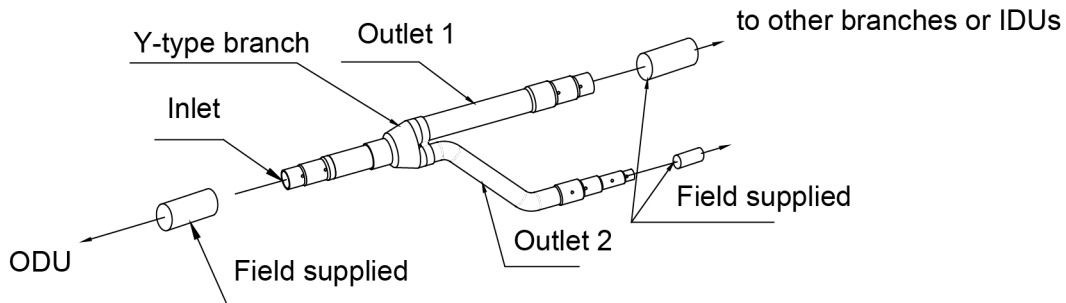

(2) Y-type branch has several pipe sections with different dimension, which facilitates to match with various copper pipes. Use pipe cutter to cut in the middle of the pipe section that is of proper dimension and remove burrs as well. See Fig. 17.

(3) Y-type branch must be installed vertically or horizontally.

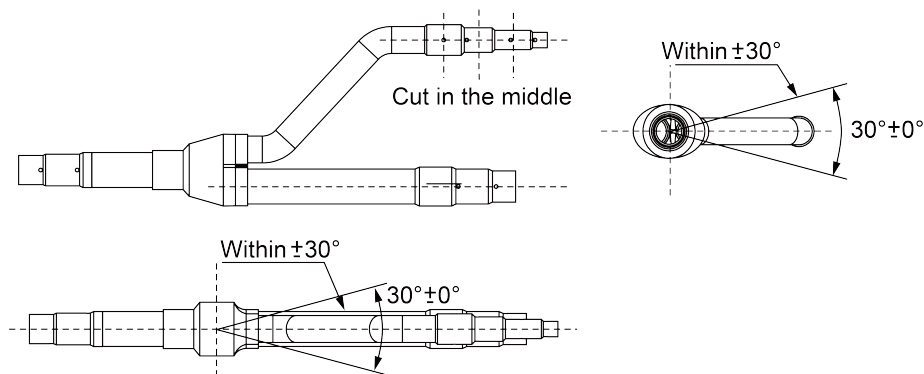

Fig. 17

NOTICE

Branch shall be isolated by insulating material that can bear 120°C (248°F) or even higher temperature. The attached foam of branch cannot be taken as insulating material.

6.1.5 Thermal Insulation for Pipeline

- (1) For multi VRF system, every copper pipe should be labeled so as to avoid misconnection.
- (2) At the branch inlet, leave at least 500mm(19-3/4inch) straight pipe section.
- (3) Thermal insulation for pipeline.
 - 1) To avoid condensate or water leakage on the connection pipe, the gas pipe and liquid pipe must be wrapped with thermal insulating material and adhesive tape for insulation from the air.
 - 2) Joints of indoor and outdoor unit should be wrapped with insulating material and leave no gap between pipe and wall. See Fig. 18.

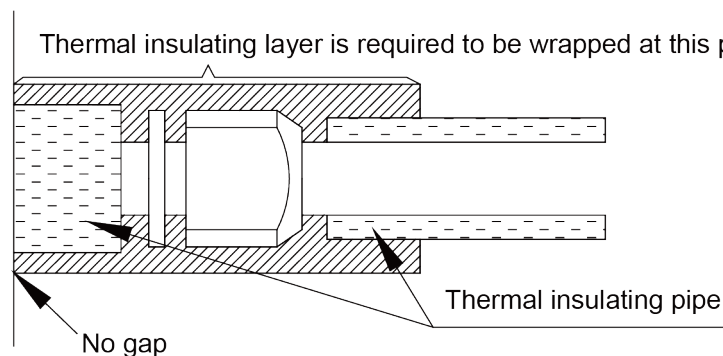

Fig. 18

- 3) When wrapping the tape, the later circle should cover half of the former one. Don't wrap the tape too tight, otherwise the insulation effect will be weakened.
- 4) After wrapping the pipe, apply sealing material to completely seal the hole on the wall.

NOTICE

- (1) Thermal insulating material shall be able bear the pipe temperature. For heat pump unit, liquid pipe should bear 70°C (158°F) or above and gas pipe should bear 120°C (248°F) or above. For cooling only unit, both liquid pipe and gas pipe should bear 70°C (158°F) or above.
- (2) Thermal insulating material of branches should be the same as that of the pipeline. The attached foam of branches cannot be taken as insulating material.

6.1.6 Support and Protection of Pipeline**CAUTION**

- (1) Support should be made for hanging connection pipe. Distance between each support cannot be over 1m(3-1/4feet).
- (2) Protection against accidental damage should be made for outdoor pipeline. When pipeline exceeds 1m(3-1/4feet), a pinch board should be added for protection.

6.2 Vacuum Pumping, Refrigerant Adding

⚠ CAUTION

Do not purge the air with refrigerants but use a vacuum pump to vacuum the installation! There is no extra refrigerant in the outdoor unit for air purging!

6.2.1 Vacuum Pumping

- (1) Outdoor unit has been charged with refrigerant before delivery. Field-installed connection pipe needs to be charged with additional refrigerant.
- (2) Confirm whether outdoor liquid and gas valves are closed.
- (3) Use vacuum pump to withdraw the air inside indoor unit and connection pipe from the outdoor valve, as shown below.

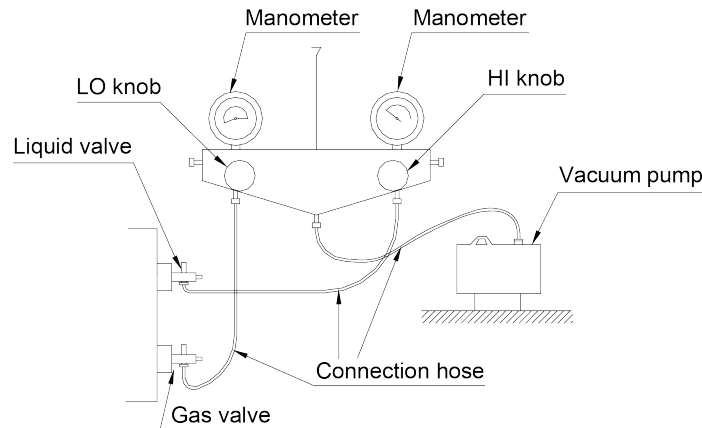

Fig. 20

6.2.2 Refrigerant Adding

- (1) Refrigerant quantity of outdoor unit before delivery:

Model	GMV-12WP/A-T(U)
Refrigerant Qty (kg/oz)	0.8 (28.2)

NOTICE

- (1) The refrigerant amount charged before delivery doesn't include the amount that needs to be added to indoor units and the connection pipeline.
- (2) Length of connection pipe is decided on site. Therefore the amount of additional refrigerant shall be decided on site according to the dimension and length of field-installed liquid pipe.
- (3) Record the amount of additional refrigerant for convenience of after-sales service.

- (2) Calculation of the amount of additional refrigerant.

Calculation method of the quantity of additional refrigerant (based on liquid pipe)

Quantity of additional refrigerant = \sum length of liquid pipe \times quantity of additional refrigerant per meter(39-3/8inch)+ Quantity of additional refrigerant for each set of indoor unit: 0.2kg (7oz)

Diameter of liquid pipe (mm/inch)	Φ 22.2 (Φ 7/8)	Φ 19.05 (Φ 3/4)	Φ 15.9 (Φ 5/8)	Φ 12.7 (Φ 1/2)	Φ 9.52 (Φ 3/8)	Φ 6.35 (Φ 1/4)
kg/m	0.35	0.25	0.17	0.11	0.054	0.022
oz/inch	0.314	0.224	0.152	0.099	0.048	0.020

NOTICE! Liquid pipe that is within 20m(65-5/8feet) doesn't need to be added with refrigerant.

First confirm that there is no leakage from the system. When compressor is not working, charge additional R410a with specific amount to the unit through the filling opening of the liquid pipe valve of the outdoor unit. If required amount cannot be quickly filled due to pressure increase of the pipe, then set the unit in cooling startup and fill refrigerant from the low pressure check valve of the outdoor unit.

(3) Calculation example.

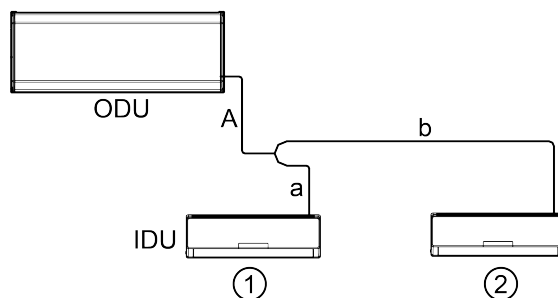

IDU:

No.	IDU ①	IDU ②
Model	Wall-mounted type GMV-ND06G/B4B-T(U)	Wall-mounted type GMV-ND06G/B4B-T(U)

Liquid pipe:

No.	A	a	b
Pipe size(mm/inch)	Φ6.35(Φ1/4)	Φ6.35(Φ1/4)	Φ6.35(Φ1/4)
Length(m/feet)	5(16-3/8)	5(16-3/8)	5(16-3/8)

Total length of each liquid pipe

Φ6.35: $A+a+b = 5+5+5=15\text{m}$ (49-1/8feet)

Quantity of indoor unit: 2 sets

Therefore, the minimum quantity of additional refrigerant $= 0.2 \times 2 + 15 \times 0.022 = 0.73\text{kg}$ (25.7oz)

7 Electric Wiring

⚠ WARNING

(1) All electrical installation must be performed by qualified technicians in accordance with local laws, regulations and this user manual.
(2) Use air conditioner specialized power supply and make sure that it is consistent with system's rated voltage.
(3) Do not pull the power cord with force.
(4) Caliber of the power cord must be large enough. A damaged power cord or connection wire must be replaced by specialized electrical cords.
(5) Connect the unit to specialized grounding device and make sure it is securely grounded. It's a must to install air switch and current circuit breaker that can cut off the power of the entire system. The air switch should include magnetic trip function and thermal trip function so that system can be protected from short circuit and overload.
(6) Air conditioner belongs to class I electrical appliance, so it must be securely grounded.
(7) The yellow-green wire inside the unit is a ground wire. Do not cut it off or secure it with tapping screws, otherwise it will lead to electric shock.
(8) Power supply must include secure grounding terminal. Do not connect the ground wire to the following: ①Water pipe; ②Gas pipe; ③Drain pipe; ④Other places that are deemed as not secure by professional technicians.

7.1 Wiring Diagram

- Connection of power cord and communication wire Separate power supply for Indoor and Outdoor.

GMV-12WP/A-T(U):

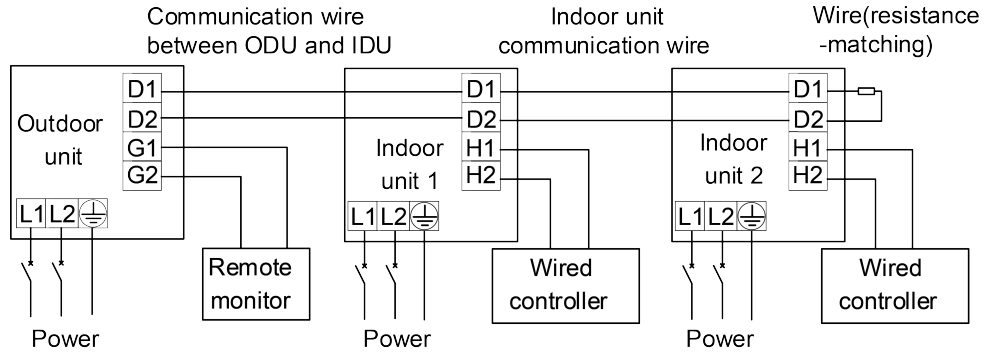

- The wiring diagram for power cord of outdoor unit and communication wire.

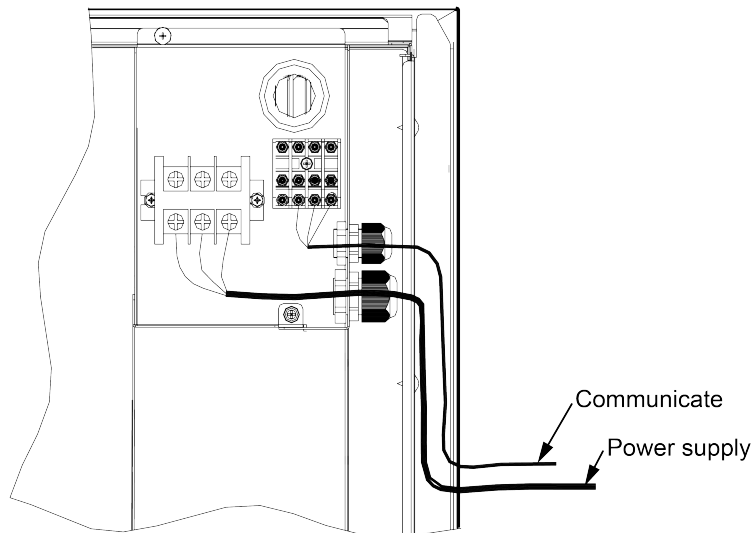

There are two wiring diagrams for communication wires of indoor/outdoor units and remote monitor:

- Real line method.
- Broken line method. Please select it based on the actual installation situation.

There are two wiring diagrams for power cord:

- Real line method.
- Broken line method. Please select it based on the actual installation situation.

7.2 Power Cable Wire Gauge and Circuit Breaker Selection

Model	Power supply	Max Fuse Size/Fusable Max. (A)	Max Ckt, Bkr Size/Disjoncteur Max. (A)	Min. Circuit Ampacity (A)
GMV-12WP/A-T(U)	208V/230V~ 60Hz	15	15	13.5

8 Debugging of Unit

⚠ CAUTION

- (1) After the initial installation is finished and the main board of outdoor unit is replaced, it must perform debugging. Otherwise, the unit can't operate.
- (2) The debugging must be performed by professional person or under the the guide of professional person.

8.1 Preparation for Debugging

- (1) Do not disconnect the power before the installation is finished.
- (2) All wires for controller and electric wires must be connected correctly and reliably.
- (3) Check the the fixing ring of the foot of compressor for transportaion is removed.
- (4) Remove all sundries from the unit, such as metal chips, joint, forceps holder, and so on.
- (5) Check whether the appearance and pipeline system are damaged during carry or transportation process.
- (6) Calculate the required added refrigerant-charging volume according to the length of pipe of system and pre-charge the refrigerant. If refrigerant can't be added any more when the required refrigerant-charging volume hasn't been reached, record to refrigerant volume which still needs to be added and continue to add refrigerant during run test operation process. Please refer to below run test for the refrigerant-adding stage during run test process.
- (7) After adding refrigerant, please make sure the valve for outdoor is opened completely.
- (8) For the convenient of troubleshooting, the unit can't be connected to the PC which installed with related debugging software and make sure that the the datas in real time of this unit can be inspected by this computer. Please refer to Service Manual for the installation and connection of the bebugging software.
- (9) Before turn test, please do make sure that the preheat time for compressor is 8h above and touch the compressor to see whether preheat is normal. You can perform run test only after normal preheat. Otherwise, it may damage the compressor.

8.2 Debugging of Unit

Description of test operation procedures and main board display of ODU.

GMV-12WP/A-T(U)

Description of each stage of debugging progress			
Progress	Debugging code		Code meaning and operation method
	LED		
	Code	Display status	
01_Set master unit	A0	ON	System is not debugged, hold main board's SW3 button for 5s to start debugging.
	01	ON	2s later, next step starts.
02_Allocate addresses	02/Ad	Display circularly	System is allocating addresses. 10s later, display as below:
	02/L7	Display circularly	No master indoor unit. Display will be on for 1min, during which master IDU can be set manually. If not, system will set the unit with minimum IP address as the master IDU.
	02/oC	Display circularly	Allocation is finished. 2s later, next step starts.
03_Confirm the quantity of ODU	03/01	Display circularly	System is confirming. 1s later, next step starts.
04_Confirm the quantity of IDU	04/00~16	Display circularly	"00~16" displays the quantity of indoor unit. Confirm the number manually. If the number is not consistent the display one, cut off power of IDU and ODU and check whether communication wire of IDU is correctly connected. After the check, connect power and start debugging from progress 01. If the number is then correct, press main board's SW3 button to confirm. Then the display is as below:
	04/oC	Display circularly	System has confirmed the quantity. 2s later, next step starts.
	00~16/CL	Display circularly	"00~16" displays the quantity of indoor unit identified by the system. "CL" means the amount of indoor unit is very little (amount of indoor unit<2), at this moment, all buttons are invalid, the system cannot enter into the next judgment.
05_Detect ODU's internal communication and capacity ratio	05/C2	Display circularly	Communication between master ODU and driver has error. Check the communication connection of ODU's main board and drive board. When the error is eliminated, start next step. If power is off during troubleshooting, then restart debugging from progress 01 after power is on.
	05/oC	Display circularly	Communication of master ODU and driver is normal. Unit will display as in the left for 2s and detect the capacity ratio of IDU and ODU. If the ratio is within range, then next step will start 2s later. If the ratio is out of range, unit will display as below:
	05/CH	Display circularly	Rated capacity ratio of IDU is too high. Change the combination way of IDU and ODU to make the ratio within range. And restart debugging from progress 01.
	05/CL	Display circularly	Rated capacity ratio of IDU is too low. Change the combination way of IDU and ODU to make the ratio within range. And restart debugging from progress 01.
06_Detect outdoor components	06/error code	Display circularly	Outdoor component's error. Besides "06", the other blinking will display the related error code. After errors are eliminated, system will start next step automatically. If power is off during troubleshooting, then restart debugging from progress 01 after power is on.
	06/oC	Display circularly	System detects no error on outdoor component. 10s later, next step starts.

Description of each stage of debugging progress			
—	Debugging code		Code meaning and operation method
Progress	LED		
	Code	Display status	
07_ Detect indoor components	07/XX/error code	Display circularly	System detects error on indoor components. XX means the project code of IDU with error, e.g. no.1 IDU has d5 and d6 errors, meanwhile no.3 IDU displays error d6 and d7, then the nixie tube will display “07”, “01”, “d5”, “d6”and “03” circularly. After errors are eliminated, system will start next step automatically. If power is off during troubleshooting, then restart debugging from progress 01 after power is on.
	07/XXXX/error code	Display circularly	If errors occur in IDU which the project code is ≥ 3-digit number, then it will display the 2 big digits of project code first, then the 2 small digits, finally the error code, e.g.: L1 error occurs in no.101 IDU, then the nixie tube will display “01”, “01” and “L1” circularly. Display method is the same for several IDUs with multiple errors.
	07/oC	Display circularly	No error on components of IDU. 5s later, next step starts.
08_ Confirm preheated compressor	08/U0	Display circularly	Preheat time for compressor is less than 8 hours. Display will be as in the left until the preheat time reaches 8 hours. Press main board's SW3 button to confirm manually that the preheat time has reached 8 hours. Then start next step (Note: Compressor may get damaged if it is started without 8 hours of preheat time).
	08/oC	Display circularly	Compressor has been preheated for 8 hours. 2s later, next step starts.
09_ Refrigerant judgments before startup	09/U4	Display circularly	System is lack of refrigerant and display will be as in the left. Please cut off power of IDU and ODU and check if there is leakage on pipeline. Solve the leakage problem and complement refrigerant into the unit. Then connect power and restart debugging from progress 01 (Note: Before re-charging refrigerant, unit must be power off in case system starts progress 10 automatically).
	09/oC	Display circularly	Refrigerant is normal and unit will display as in the left for 2s. Then next step starts.
10_ Status judgments of outdoor valves before startup	10/on	Display circularly	Valves of ODU are being inspected. Compressor will start operation for 2min or so and then stop. The opening and closing status of outdoor valves are as below:
	10/U6	Display circularly	Outdoor valves are not fully turned on. Press main board's SW4 button and display shows “09/OC”. Then check if the gas and liquid valves of ODU are completely open. After confirmation, press the SW4 button again. Then compressor will start running for about 2min to inspect the status of valves.
	10/oC	Display circularly	Valves status is normal. Unit will display as in the left for 2s and then start next step.

Description of each stage of debugging progress			
—	Debugging code		Code meaning and operation method
Progress	LED		
	Code	Display status	
12_ Confirm debugging startup	12/AP	Display circularly	Ready for units to start debugging. Press main board's SW3 button to confirm startup of debugging. 2s later, main board will display as below:
	12/AE	Display circularly	Startup is confirmed. After displaying for 2s, system will choose "15_Cooling debugging" or "16_Heating debugging" according to ambient temperature. If the project requests to add refrigerant but it is not complemented before debugging, then refrigerant can be added in this process through the L-VALVE.
15_ Cooling debugging	15/AC	Display circularly	Debugging for cooling mode. If no malfunction occurs for 50min when compressor is running, then the system is certified as normal. After shutting down the unit for 5s, the system will enter normal standby status.
	15/error code	Display circularly	Malfunction occurs when debugging for cooling mode.
16_ Heating debugging	16/AH	Display circularly	Debugging for heating mode. If no malfunction occurs for 50min when compressor is running, then the system is certified as normal. After shutting down the unit for 5s, the system will enter normal standby status.
	16/error code	Display circularly	Malfunction occurs when debugging for heating mode.
17_ Debugging finished	oF	ON	The entire unit has finished debugging and under standby-by condition.

8.3 Parameters Reference Value for the Normal Operation of Unit

No.	Debug item	Parameter name	Unit	Reference					
1	System parameters	ODU parameters	Outdoor temperature	°C(°F)	—				
2			Compressor discharge temp	°C(°F)	When compressor starts, discharge temp in cool mode is within 70~105°C (158~221°F) and at least 10°C (50°F) higher than the high pressure saturation temp. As for temp in heat mode, it is within 65~90°C (149~194°F) and at least 10°C (50°F) higher than the high pressure saturation temp.				
3			Defrosting temp	°C(°F)	In cool mode, defrosting temp is 4~10°C (39~50°F) lower than system's high pressure value; In heat mode, defrosting temp is about 2°C(36°F) different from system's low pressure value.				
4			System high pressure	°C(°F)	In cool mode, the normal high pressure value is within 20°C~55°C (68~131°F). According to the change of ambient temp and system's operating capacity, the high pressure value will be 10°C~30°C (50~86°F) higher than ambient temp. The higher ambient temp is, the smaller temp difference is. If ambient temp is 25~35°C (77~95°F) in cool mode, system's high pressure value will be within 44~53°C(111~127°F). In heat mode, if ambient temp is above -5°C (23°F), system's high pressure value is within 40~52°C (104~126°F). If ambient temp is low and many IDUs are turned on, the high pressure will be lower.				
5			System low pressure	°C(°F)	When ambient temp in cool mode is 25~35°C (77~95°F), the low pressure value is 0~8°C (32~46°F). When ambient temp in heat mode is above -5°C (23°F), the low pressure value is -15~8°C (5~46°F).				
6			Opening angle of thermal EXV	PLS	In cool mode, the thermal electronic expansion valve remains 480PLS. In heat mode, the adjustable opening angle of EXV is 60~480PLS.				
7			Compressor's operating freq	Hz	GMV-12WP/A-T(U)	Changes in 15Hz~75Hz.			
8			Compressor's operating current	A	When compressor works normally, the current is no more than 8.2A.				
9			Compressor's IPM temp	°C(°F)	When ambient temp is below 35°C (95°F), IPM temp is lower than 80°C (176°F) and the highest temp won't be above 95°C (203°F).				
10			Fan motor's operating freq	Hz	Changes in 0~70Hz according to system's pressure.				
11			IDU parameters	IDU ambient temp	°C(°F)	—			
12				Indoor heat exchanger's inlet temp	°C(°F)	According to ambient temp, for a same IDU in cool mode, the inlet temp will be 1°C~7°C (34~45°F) lower than the outlet temp, and 4~9°C (39~48°F) higher than the low pressure value. For a same IDU in heat mode, the inlet temp will be 10°C~20°C(50~68°F) lower than the outlet temp.			
13						Opening angle of indoor EXV	PLS	In cool mode, the opening angle of indoor EXV varies within 70~480PLS.	
14								In heat mode, the opening angle of indoor EXV varies within 70~480PLS.	

No.	Debug item	Parameter name	Unit	Reference
15	Communication parameters	Communication data	—	Number of IDUs detected by software is the same with the actual number. No communication error.
16	Drainage system	—	—	Indoor unit can drain water out completely and smoothly. Condensate pipe has no backward slope of water; Water of outdoor unit can be drained completely through drainage pipe. No water drop from unit base.
17	Others	—	—	Compressor and indoor/outdoor fan motor do not have strange noise. Unit can operate normally.

MAINTENANCE

MAINTENANCE

1 Malfunction List

1.1 Malfunction List for the Wired Controller

Indoor:

Error Code	Content	Error Code	Content	Error Code	Content
L0	Indoor Unit Error	L9	Quantity Of Group Control Indoor Units Setting Error	d7	Humidity Sensor Error
L1	Indoor Fan Protection	LA	Indoor Units Incompatibility Error	d8	Water Temperature Sensor Error
L2	E-heater Protection	LH	Low Air Quality Warning	d9	Jumper Cap Error
L3	Water Full Protection	LC	Outdoor-Indoor Incompatibility Error	dA	Indoor Unit Hardware Address Error
L4	Wired Controller Power Supply Error	d1	Indoor Unit Circuit Board Error	dH	Wired Controller Circuit Board Error
L5	Anti-freezing Protection	d3	Ambient Temperature Sensor Error	dC	Capacity DIP Switch Setting Error
L7	No Master Indoor Unit Error	d4	Inlet Pipe Temperature Sensor Error	dL	Outlet Air Temperature Sensor Error
L8	Power Insufficiency Protection	d6	Outlet Pipe Temperature Sensor Error	dE	Indoor Unit CO ₂ Sensor Error
o1	Over low voltage of IDU bus	o2	Over high voltage of IDU bus	o3	IDU IPM module protection
o4	IDU startup failure	o5	IDU overcurrent protection	o6	IDU current detecting circuit error
o7	IDU non-synchronism protection	o8	IDU drive communication error	o9	Communication error of IDU master controller
oA	Over high temperature of IDU module	ob	Temperature sensor error of IDU module	oC	IDU charging circuit error
o0	Other drive error	db	Special Code: Field Debugging Code	—	—

1.2 Status Display Table for Indicators on Main Board of Outdoor Unit

Definition:

LED1: It displays “00” for hot water mode as for DC Inverter Side Discharge VRF.

LED2: It displays “AC” for AC mode, cooling and cooling OFF mode for indoor unit, and displays “AH” for heating and heating OFF mode for indoor unit.

LED3: It displays on or off status of compressor and malfunction code. It displays “ON” when the compressor is operating and “OFF” when the compressor stops operation. When there's malfunction for the unit, it will display corresponding malfunction code; when there're multiple malfunctions, the malfunction codes will be displayed in turn.

Outdoor:

Error Code	Content	Error Code	Content
E0	Malfunction of ODU (uniform)	F0	Main board of ODU is poor
E1	High-pressure protection	F1	Malfunction of high-pressure sensor
E2	Discharge low-temperature protection	F3	Malfunction of low-pressure sensor

Error Code	Content	Error Code	Content
E3	Low-pressure protection	F5	Malfunction of discharge temperature sensor of compressor 1
E4	High discharge temperature protection of compressor	FP	Malfunction of DC motor
E5	High discharge temperature protection of compressor 1	b1	Malfunction of outdoor ambient temperature sensor
EC	Drop protection of discharge temperature sensor of compressor 1	b2	Malfunction of defrosting temperature sensor 1
J1	Over-current protection of compressor 1	b4	Malfunction of liquid temperature sensor of sub-cooler
J7	Gas-mixing protection of 4-way valve	b5	Malfunction of gas temperature sensor of sub-cooler
J8	High pressure ratio protection of system	b6	Malfunction of inlet tube temperature sensor of vapor liquid separator
J9	Low pressure ratio protection of system	b7	Malfunction of exit tube temperature sensor of vapor liquid separator
JA	Protection because of abnormal pressure	b9	Malfunction of gas temperature sensor of heat exchanger
JC	Water flow switch protection (GMV-12WP/A-T(U) is Water Full Protection)	bA	Malfunction of oil-return temperature sensor 1
JL	Protection because high pressure is too low	bH	Clock of system is abnormal
P0	malfunction of driving board of compressor (uniform)	H0	Malfunction of driving board of fan (uniform)
P1	Driving board of compressor operates abnormally (uniform)	H1	Driving board of fan operates abnormally (uniform)
P2	Voltage protection of driving board power of compressor (uniform)	H2	Voltage protection of driving board power of fan (uniform)
P3	Reset protection of driving module of compressor	H3	Reset protection of driving module of fan
P4	Drive PFC protection of compressor	H4	Drive PFC protection of fan
P5	Over-current protection of inverter compressor	H5	Over-current protection of inverter fan
P6	Drive IPM module protection of compressor	H6	Drive IPM module protection of fan
P7	Malfunction of drive temperature sensor of compressor	H7	Malfunction of drive temperature sensor of fan
P8	Drive IPM high temperature protection of compressor	H8	Drive IPM high temperature protection of fan
P9	Desynchronizing protection of inverter compressor	H9	Desynchronizing protection of inverter fan
PH	High-voltage protection of compressor's drive DC bus bar	HH	High-voltage protection of fan's drive DC bus bar
PC	Malfunction of current detection circuit drive of compressor	HC	Malfunction of current detection circuit of fan drive
PL	Low voltage protection for DC bus bar of drive of compressor	HL	Low voltage protection of bus bar of fan drive
PE	Phase-lacking of inverter compressor	HE	Phase-lacking of inverter fan
PF	Malfunction of charging loop of driven of compressor	HF	Malfunction of charging loop of fan drive
PJ	Failure startup of inverter compressor	HJ	Failure startup of inverter fan
PP	AC current protection of inverter compressor	HP	AC current protection of inverter fan
Ed	Low temperature protection for drive module	—	—

Debugging:

Error Code	Content	Error Code	Content
U0	Preheat time of compressor is insufficient	C4	Malfunction of lack of IDU
U2	Wrong setting of ODU's capacity code/jumper cap	C5	Alarm because project code of IDU is inconsistent
U4	Refrigerant-lacking protection	C8	Emergency status of compressor
U5	Wrong address for driving board of compressor	C9	Emergency status of fan
U6	Alarm because valve is abnormal	CH	Rated capacity is too high
U8	Malfunction of pipeline for IDU	CC	Malfunction of lack of main control unit
U9	Malfunction of pipeline for ODU	CL	Rated capacity is too low
UC	Setting of main IDU is successful	CF	Malfunction of multiple main control units
UL	Wrong button-dial	CJ	Address DIP switch code of system is shocking
UE	Charging of refrigerant is invalid	CP	Malfunction of multiple wired controller
C0	Communication malfunction between IDU, ODU and IDU's wired controller	CU	Communication malfunction between IDU and the receiving lamp plate
C2	Communication malfunction between main control and inverter compressor driver	Cb	Overflow distribution of IP address
C3	Communication malfunction between main control and inverter fan driver	—	—

Status:

Error Code	Content	Error Code	Content
A0	Unit waiting for debugging	AP	Debugging confirmation when starting up the unit
A1	Inquiry of compressor operation parameters	AU	Long-distance emergency stop
A2	Refrigerant recovery operation of after-sales	Ab	Emergency stop of operation
A3	Defrosting	Ad	Limit operation
A4	Oil-return	n0	SE operation setting of system
A6	Heat pump function setting	n1	Setting of defrosting cycle K1
A7	Quiet mode setting	n2	Setting of upper limit of IDU/ODU capacity distribution ratio
A8	Vacuum pump mode	n4	Limit setting for max. capacity/output capacity
A9	IPLV test	n6	Inquiry of malfunction
AA	EU AA level EER test mode	n7	Inquiry of parameters
AH	Heating	n8	Inquiry of project code of IDU
AC	Cooling	nA	Heat pump unit
AL	Charge refrigerant automatically	nH	Heating only unit
AE	Charge refrigerant manually	nC	Cooling only unit
AF	Fan	nE	Negative code
AJ	Cleaning reminding of filter	nF	Fan model
q1	Anti-ice temperature setting under low temperature condition	qA	Heat recover status
q2	Shield setting for compressor frequency	qH	main body conducts heating
q3	Upper limit of correction value for target low pressure is Z0	qC	The main body conducts cooling

Error Code	Content	Error Code	Content
q4	Upper limit of correction value for target low pressure is Z2	qL	Static pressure setting
q5	Setting for general unit and high sensible heat unit (0 represents general, 1 represents high sensible heat)	qE	EVI operation status setting
q6	Setting for engineering ability correction factor θ	qF	Compulsory cooling mode
q7	Select Centigrade or Fahrenheit	qJ	Dual heat source water emptying
q8	Low temperature protection correction value for discharge	qy	Working mode of compressor heating zone
q9	Defrost mode setting	—	—

2 Troubleshooting

Troubleshooting principle

(1) Communication malfunction.

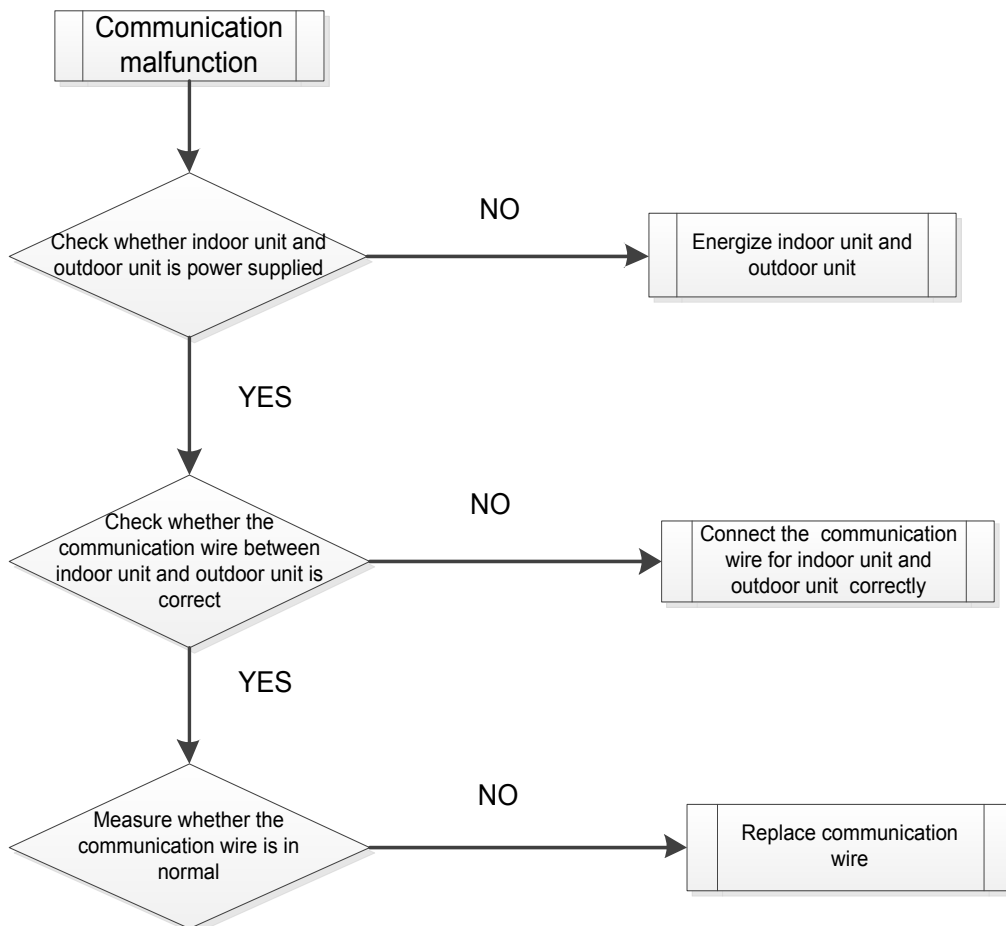

(2) High pressure protection.

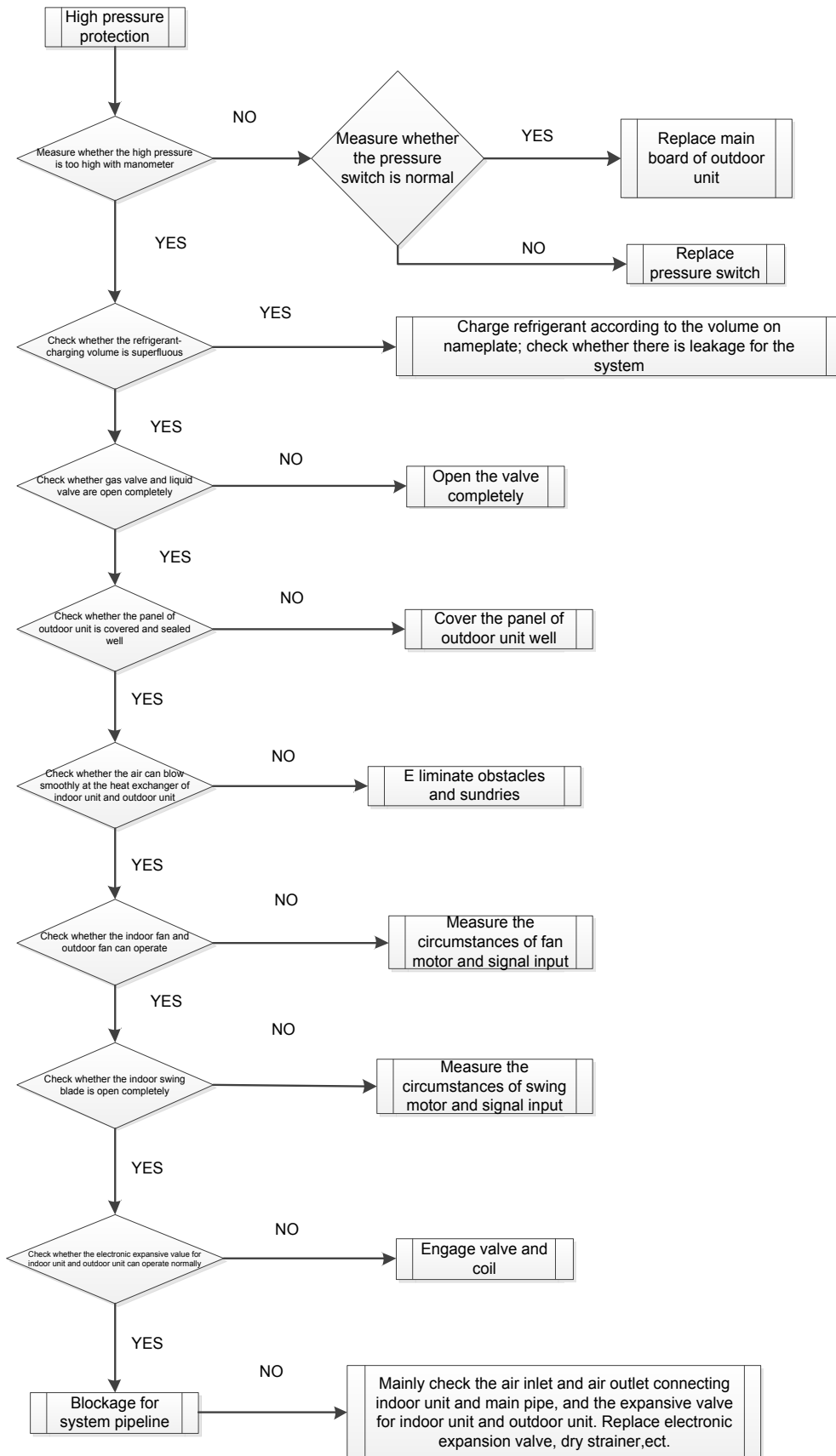

(3) Low-pressure protection.

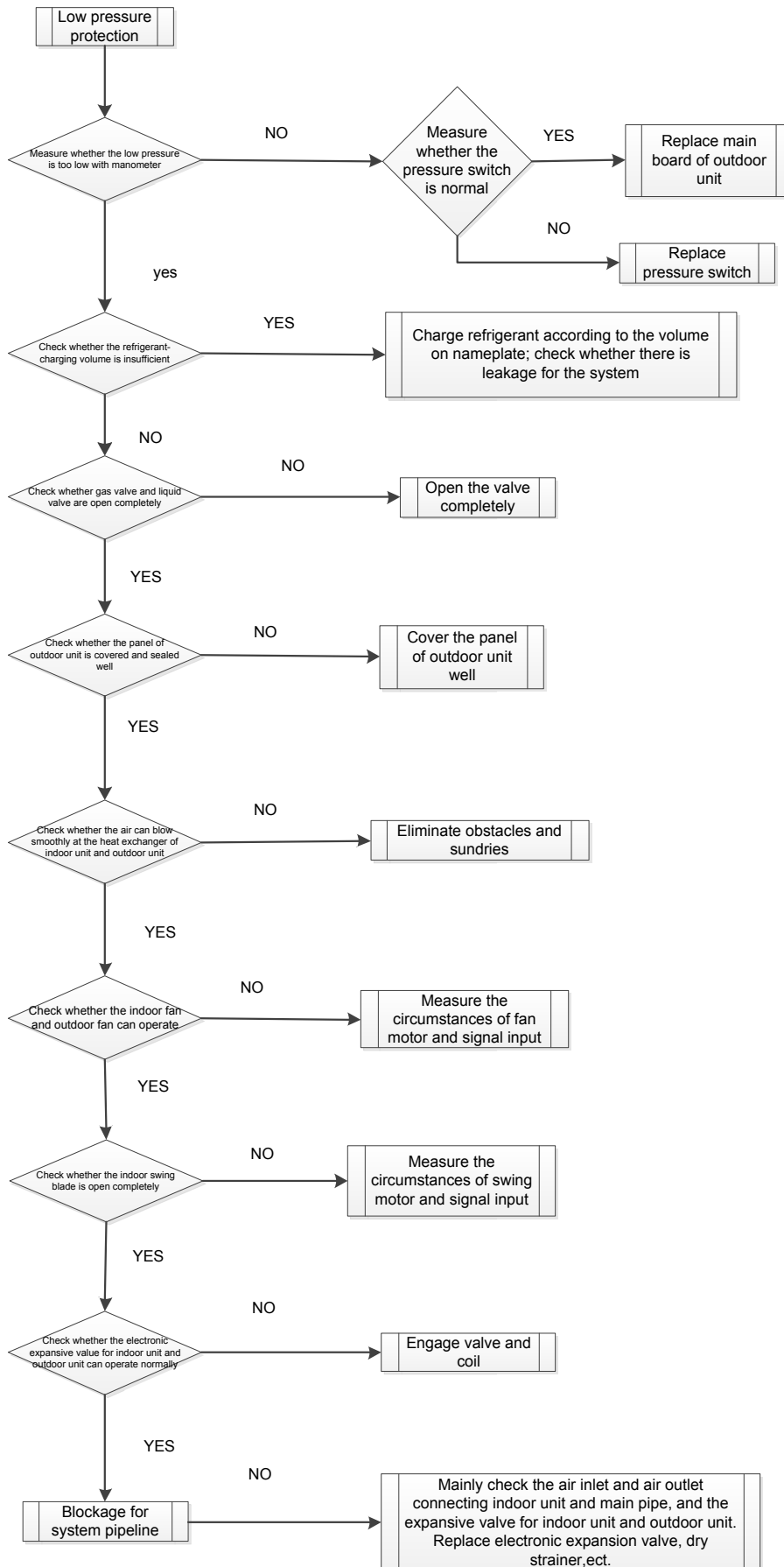

(4) Discharge temperature protection.

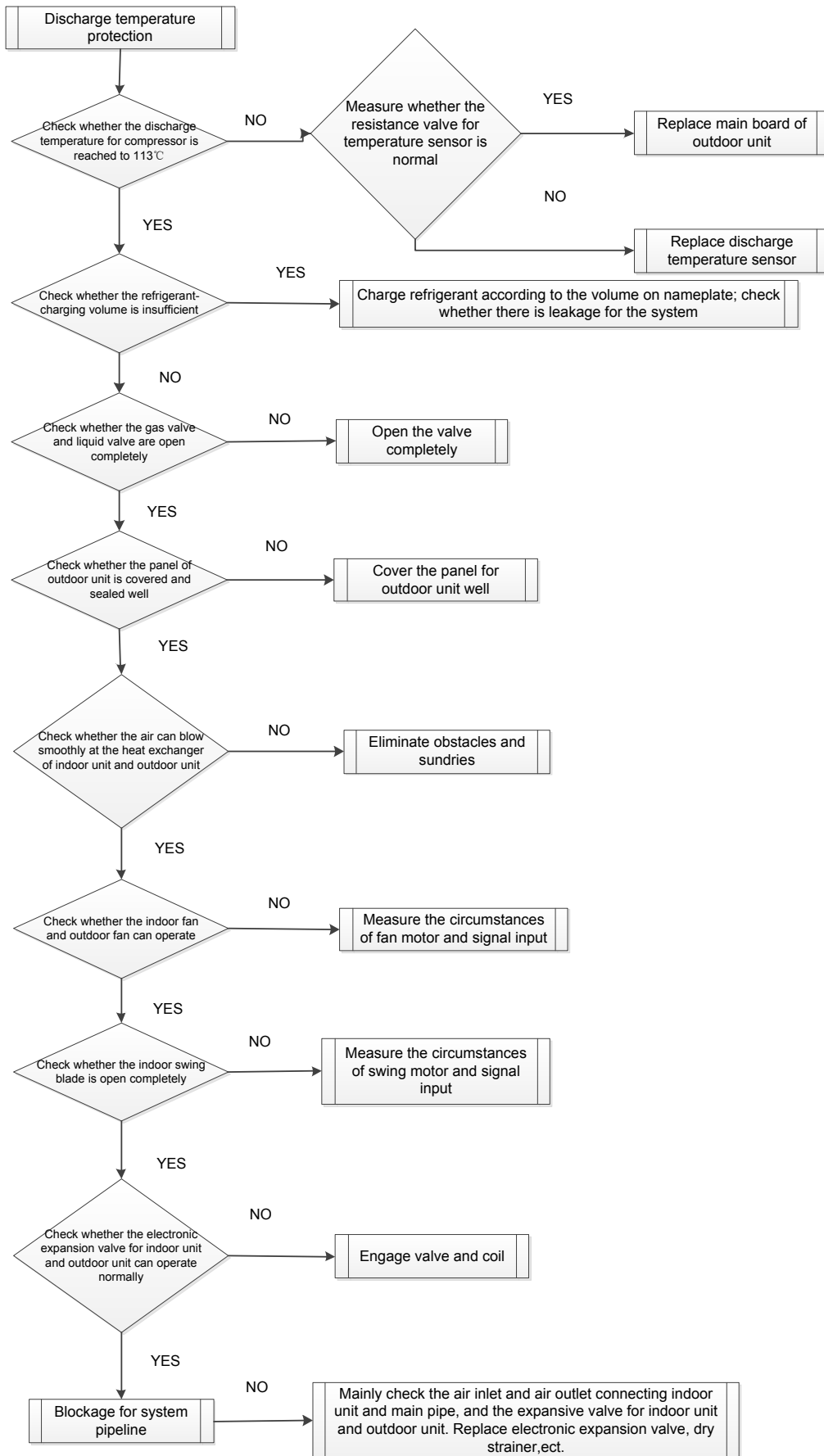

(5) Malfunction of temperature sensor.

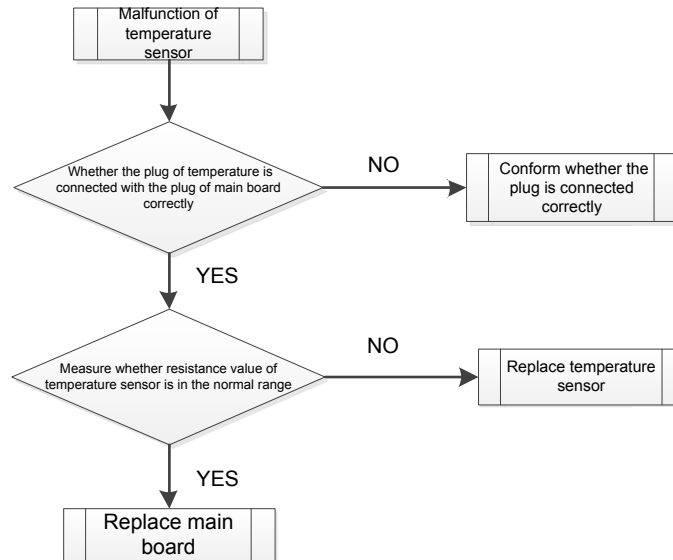

(6) Malfunction of sensor.

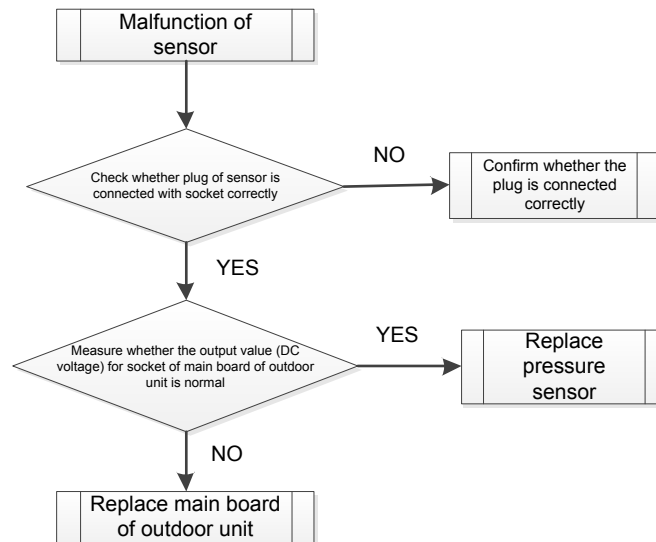

(7) Unit and main board can't be energized.

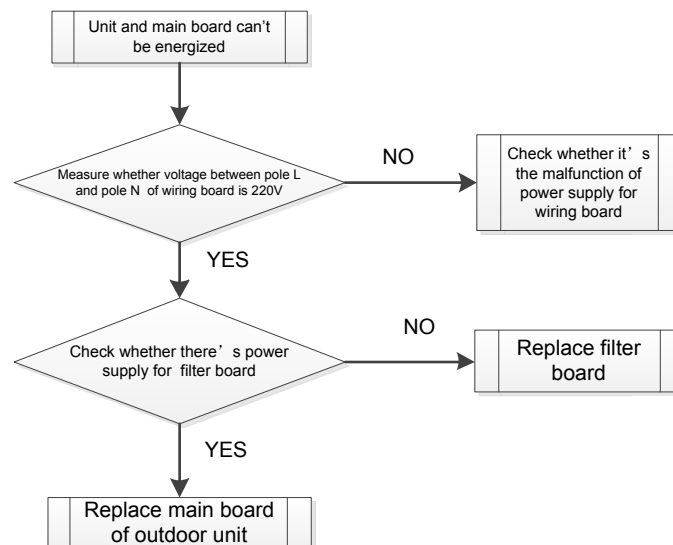

(8) Failure start-up.

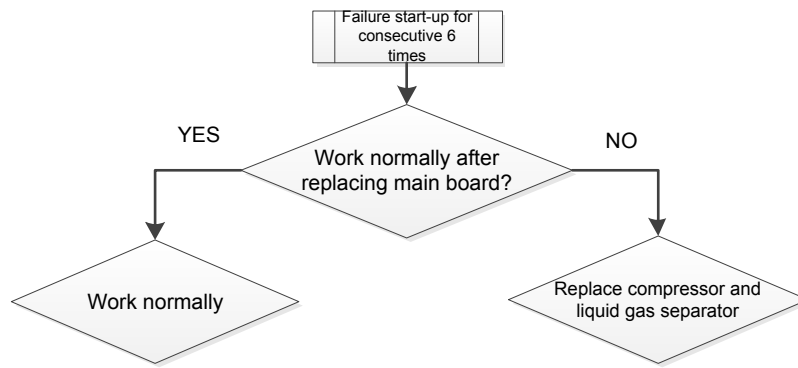

(9) Reset protection for drive module of compressor, drive PFC protection for compressor, malfunction of drive temperature sensor for compressor, circuit malfunction of drive current detection for compressor.

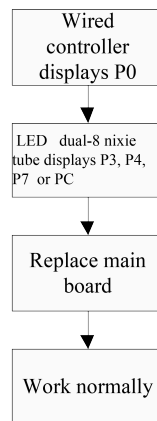

(10) Drive IPM overtemperature protection for compressor.

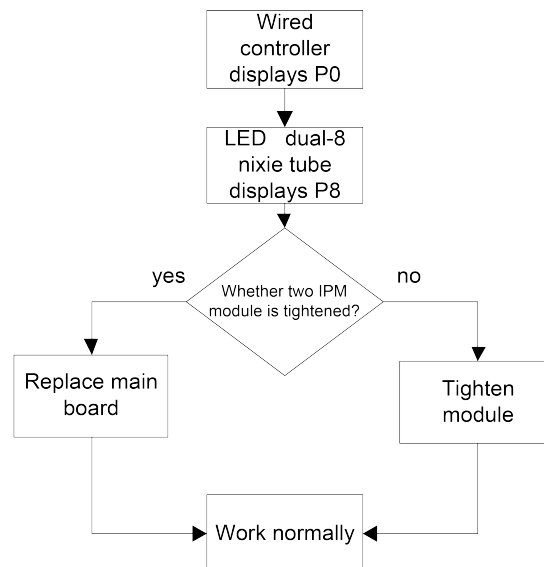

(11) Desynchronizing protection for inverter compressor.

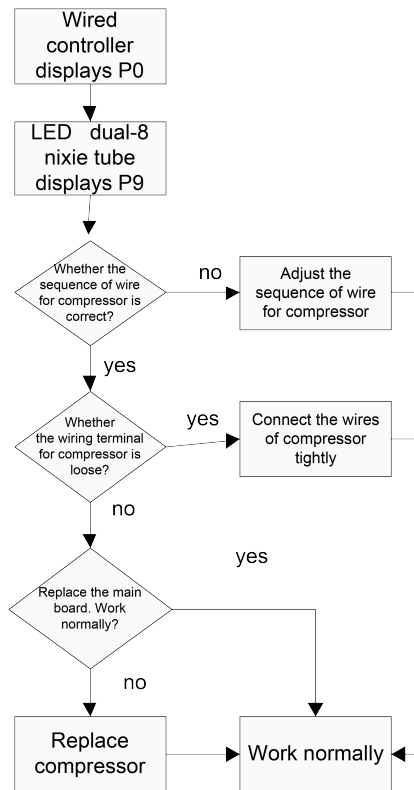

(12) Failure startup for inverter compressor.

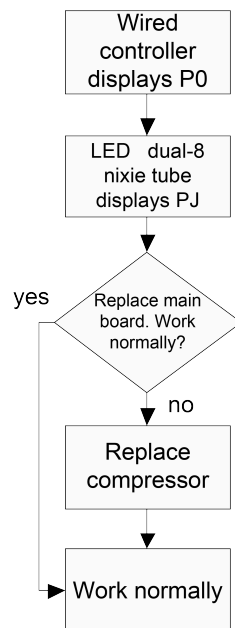

(13) Loop malfunction of driven charging for compressor.

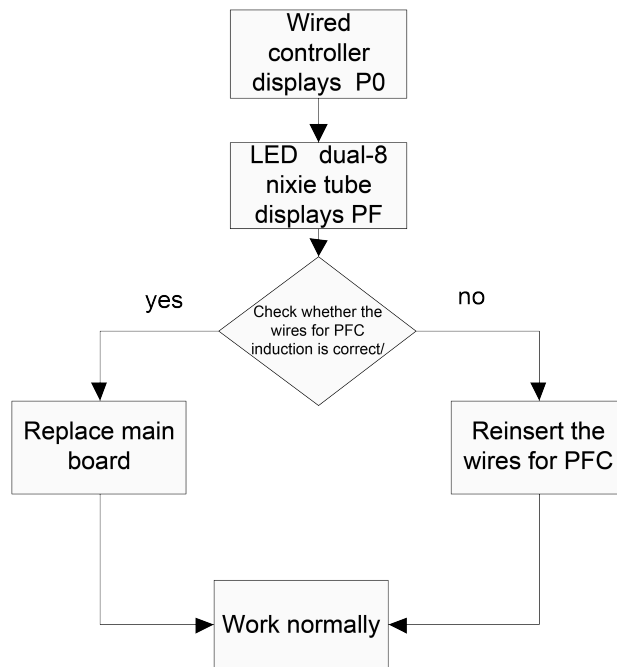

(14) Malfunction of memory chip for inverter compressor.

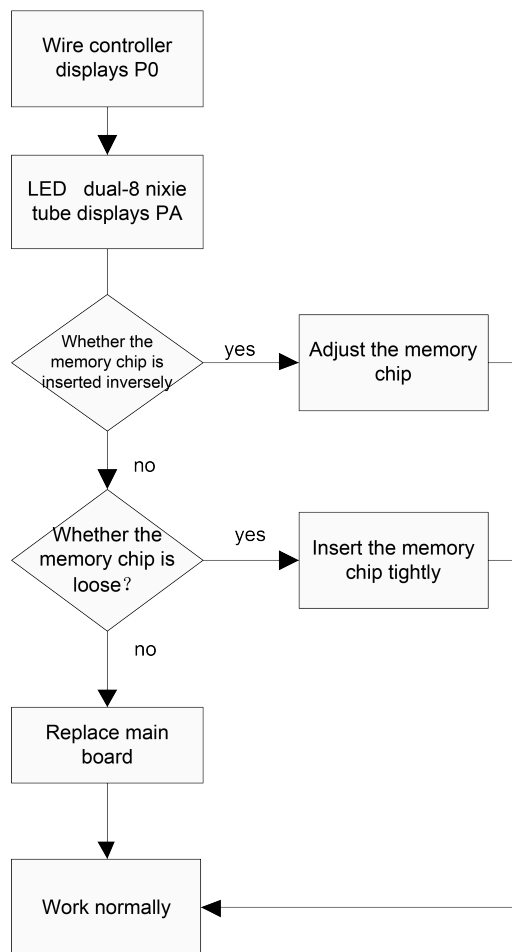

(15) Overcurrent protection for inverter compressor, IPM module protection, phase-lacking of inverter compressor.

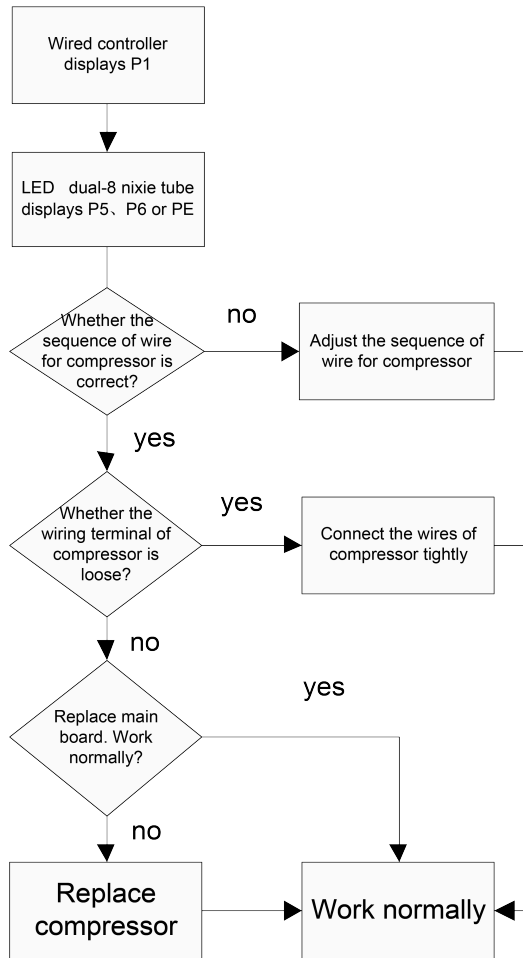

(16) High pressure protection for driven DC bus bar of compressor, low pressure protection for driven DC bus bar of compressor.

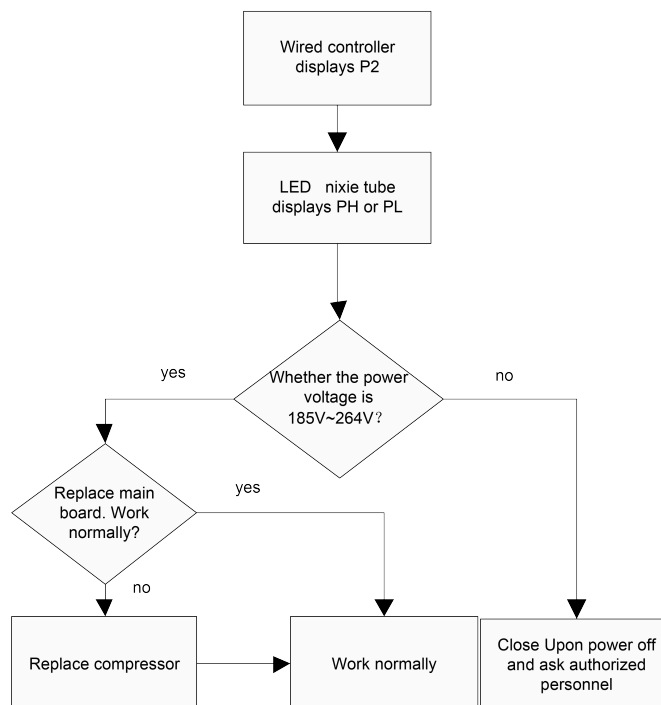

(17) AC current protection for inverter compressor.

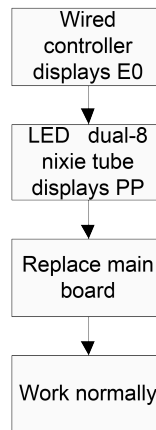

(18) Communication malfunction between main controller and driver of inverter compressor.

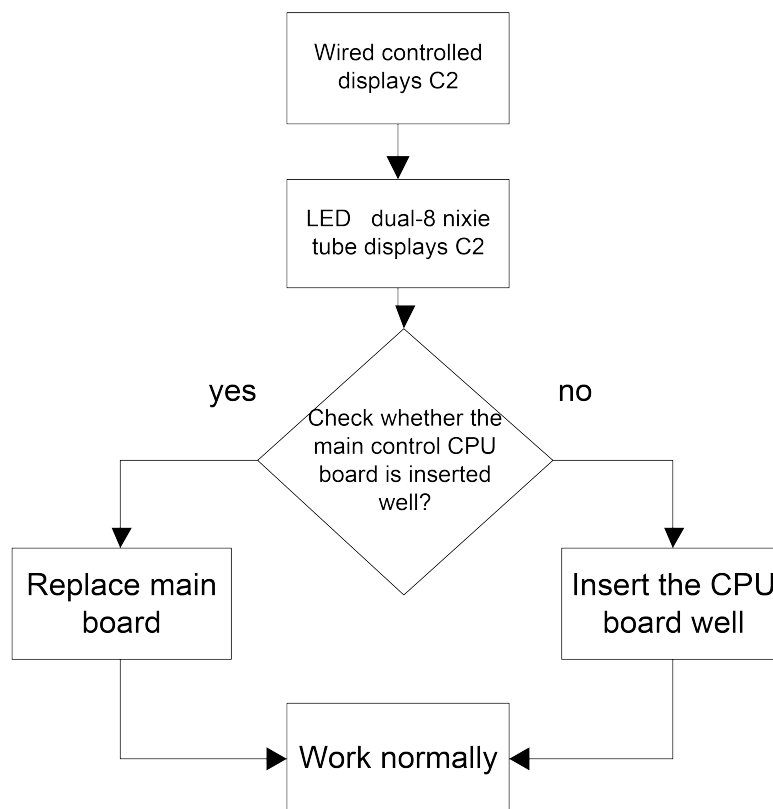

3 Power Distribution of Unit

3.1 Power Distribution of Unit

The control logical relationship among parts inside the electric box of unit is showed by the mongline diagram (CAD source file).

The main loop is showed by bold line (line width: 1mm); the control loop is showed by slim line (line width: 0.2mm).

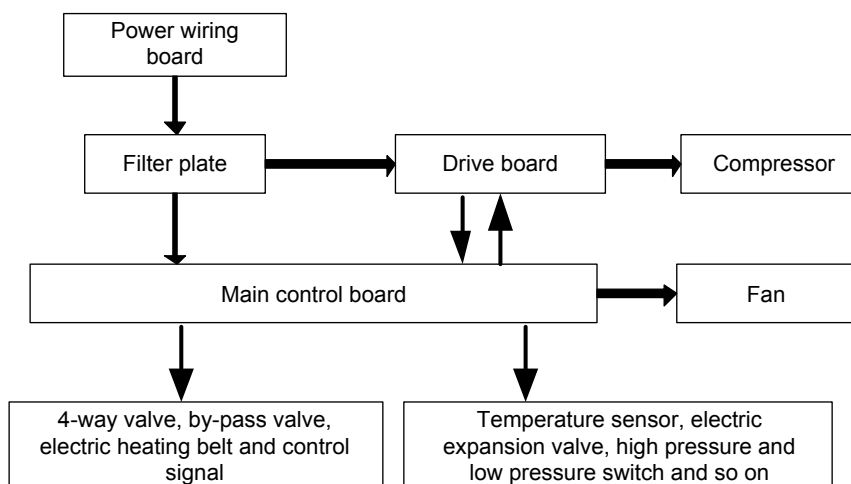

(Bold line is the power line and the slim line is the control line)

3.2 Main Electric Parts

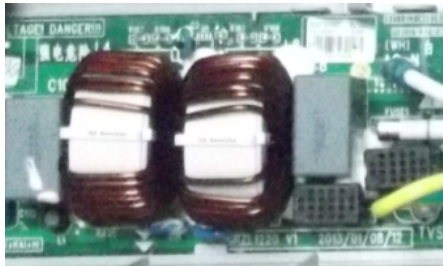
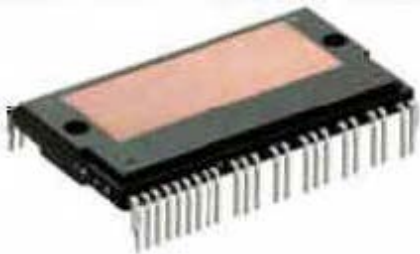
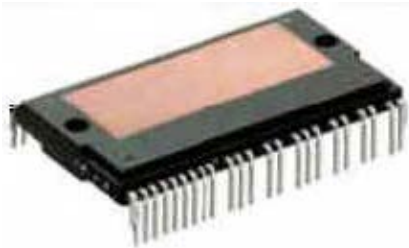
Name	Photo	Function introduction
Filter plate		It main effect is to eliminate the interference of power for protecting unit's anti-interference capability and prevent the interference to other electric appliances.
IPM Module		There are three complementary IGBT tube inside the IPM module. They are controlled by PWM wave and then bring the pressure of DC bus bar to different stator windings of compressor at different stage, and then generate current on the stator. Meanwhile, magnetic field will be generated on the stator winding, and push the operation of rotor and then drive compressor to operate.
PFC module		Four diodes and two MOS pipe are intergrated inside the PFC module. It will transform AC input power into DC power. Meanwhile, MOS pipe is controlled by PWM wave. Pressure will be increased by induction.

3.3 Circuit Diagram

GMV-12WP/A-T(U)

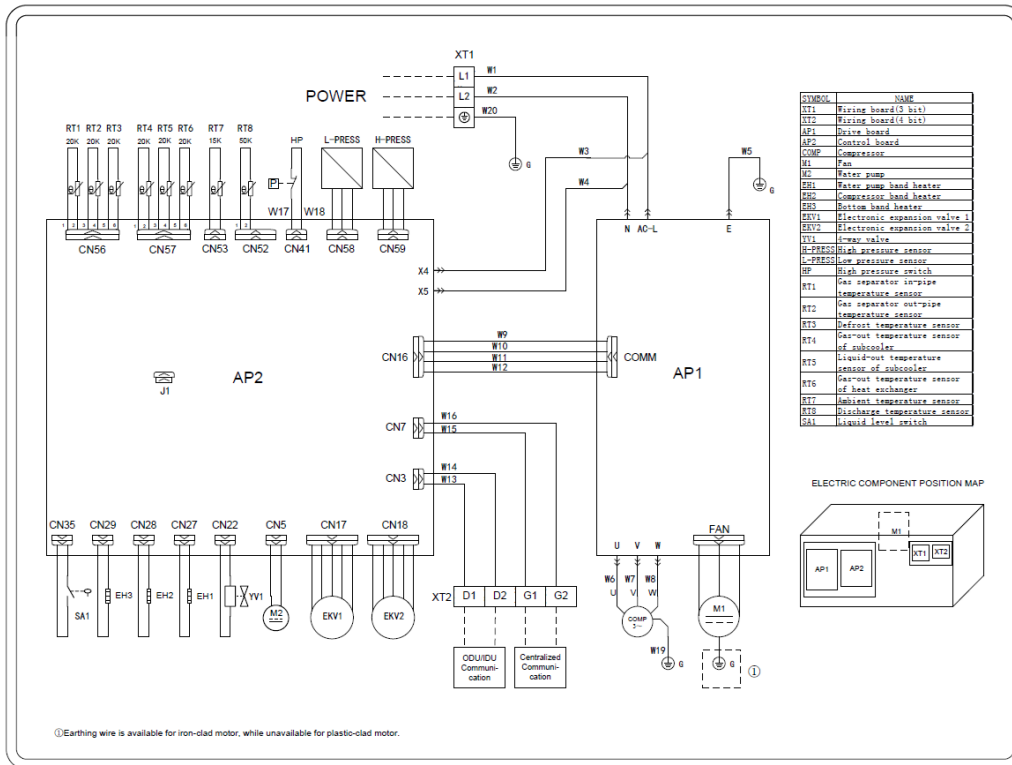

4 Removal of Parts

4.1 Key Parts

Photo	Name	Function
	compressor	Core part of air conditioning system. It sucks low temperature and low pressure gas, compress it to high temperature and high pressure gas, and then discharge it.
	Electronic expansion valve	Throttling device. It transforms high pressure refrigerant liquid into low pressure steam.
	4-way valve	It changes the flow direction of refrigerant for switching between cooling and heating.

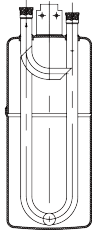
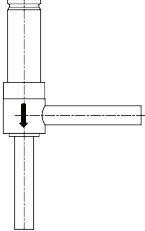
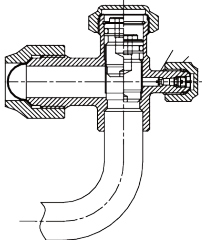
Photo	Name	Function
	Vapour liquid separator	It stays between outlet of evaporator and suction outlet of compressor. It used for separating low temperature and low pressure refrigerant.
	Solenoid valve	—
	Cut-off valve	It used for connecting indoor unit and outdoor unit, and used for maintenance and installation.

4.2 Removal of Key Parts

4.2.1 GMV-12WP/A-T(U), Series Unit

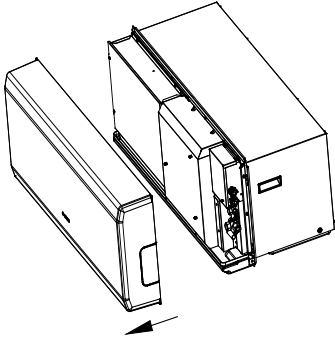
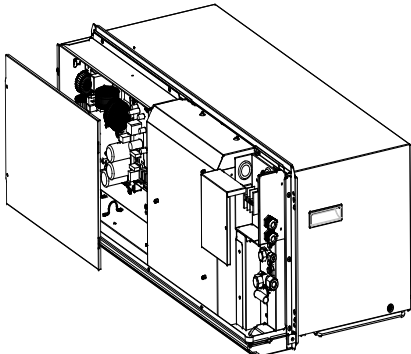
Removal operation for panel		
Remark: Before removing the panel, please make sure that the unit is disconnected with the power		
Process	Photo	Operation Instruction
(1) Remove Injection Molding Panel		<ul style="list-style-type: none"> ● Loose the spring clasp at both ends of panel forcibly. ● Then remove the Injection Molding Panel.
(2) Remove electric box cover and terminal box cover.		<ul style="list-style-type: none"> ● Loose screws fixing the electric box cover and the terminal box cover with a screwdriver. ● Remove the electric box and the terminal box cover.

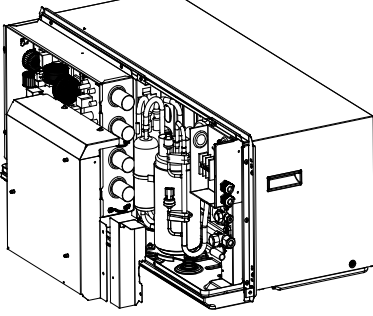
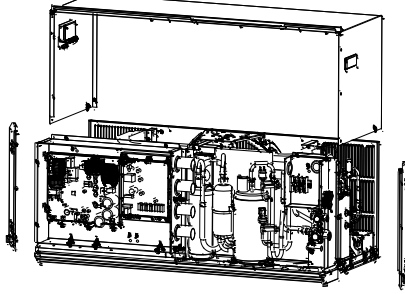
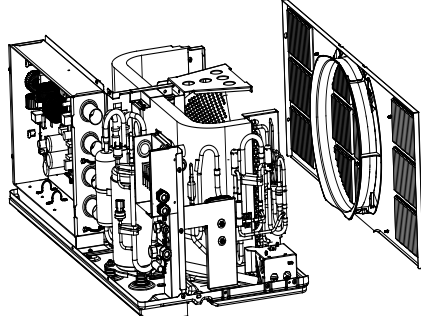
Removal operation for panel		
Remark: Before removing the panel, please make sure that the unit is disconnected with the power		
Process	Photo	Operation Instruction
(3) Remove soundproof case panel.		<ul style="list-style-type: none"> ● Loose the screws fixing the soundproof case panel with a screwdriver. ● Remove the soundproof case panel.
(4) Remove top cover.		<ul style="list-style-type: none"> ● Loose the screws fixing the front panel, left side, right side and rear panel with screwdriver. ● Then remove the top cover.
(5) Remove rear panel and grille.		<ul style="list-style-type: none"> ● Loose the screws fixing the rear panel and grille with screwdriver. ● Then remove the rear panel and grille.

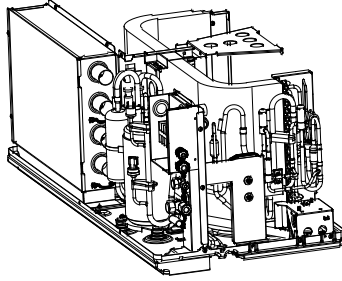
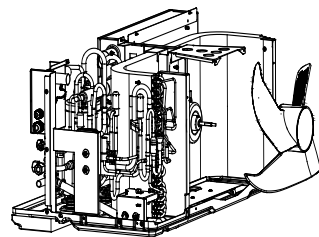
Removal operation for blade and motor.		
Remark: Before removing the motor, please make sure that the unit is disconnected with the power.		
Process	Photo	Operation Instruction
(1) Removal operation for panel.		<ul style="list-style-type: none"> ● Loose the screws fixing the panel with screwdriver. ● Then remove the operation for panel.
(2) Remove blade.		<ul style="list-style-type: none"> ● Loosen nuts fixing the blade with wrench. ● Then remove the blade and put it on the floor flatly.

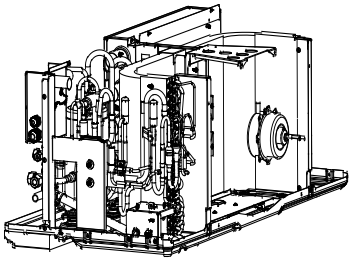
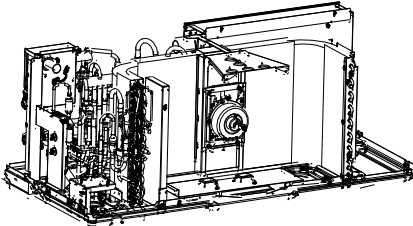
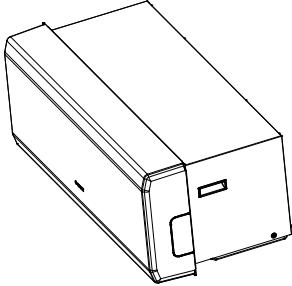
Removal operation for blade and motor.		
Remark: Before removing the motor, please make sure that the unit is disconnected with the power.		
Process	Photo	Operation Instruction
(3) Remove motor.		<ul style="list-style-type: none"> ● Loose screws fixing the motor with screwdriver. ● then remove the power cord of motor. ● Take out the damaged motor.
(4) Install motor.		<ul style="list-style-type: none"> ● Replace the motor, tighten screws with screwdriver and then connect the power cord of motor.
(5) Assemble unit.		<ul style="list-style-type: none"> ● Assemble the unit in the the converse sequence.

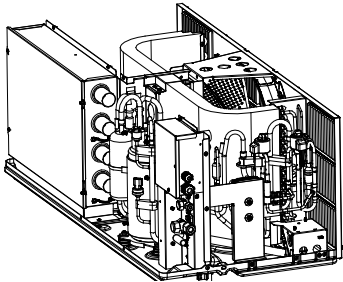
Removal operation of compressor.		
Remark: Before removing the compressor, please make sure that there's no refrigerant inside the pipeline and the power is disconnected.		
Process	Photo	Operation Instruction
(1) Remove wiring cover of compressor. (2) Disconnect compressor and connected pipeline. (3) Loose nuts fixing the foot of compressor.		<ul style="list-style-type: none"> ● Loose screws fixing the compressor with screwdriver. ● Then pull out the power cord Note: When removing the power cord, make marks for different color power cords and corresponding wiring terminals for wrong. ● Weld suction pipe and discharge pipe of compressor. ● Then pull out the connection pipe from the compressor. Note: During welding process, do not let the flame burn out other parts. ● Twist off the nuts for compressor with wrench.

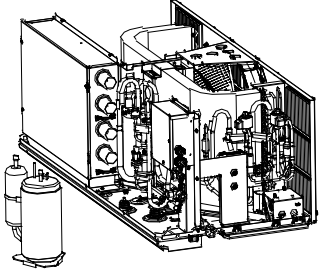
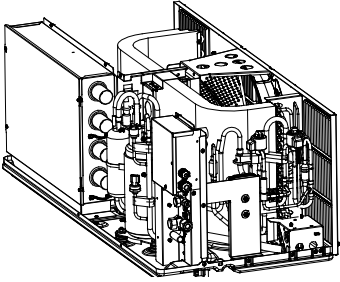
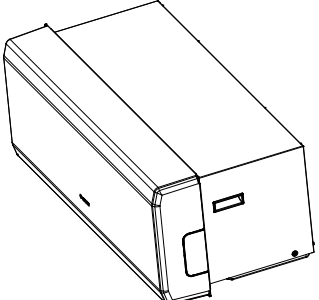
Removal operation of compressor.		
Remark: Before removing the compressor, please make sure that there's no refrigerant inside the pipeline and the power is disconnected.		
Process	Photo	Operation Instruction
(4) Remove the compressor from the chassis.		<ul style="list-style-type: none"> ● Take out the compressor and replace it. Note: When replacing the compressor, do not damage nearby pipelines and other parts.
(5) Fix the new compressor at the chassis. (6) Connect suction pipe and discharge pipe of compressor and pipeline of system again. (7) Connect the power cord of compressor well.		<ul style="list-style-type: none"> ● After replacing the compressor, fix the nuts at the bottom of compressor. ● Weld the connection pipe of compressor, connect the pipeline and compressor Note: During welding process, do not let flame burn out other parts. ● Loose screws fixing the power cord with screwdriver. ● Conenct the power cord well again.Note: When connecting the power cord, make marks for different color power cords and corresponding wiring terminals.
(8) Check and open the upper cover plate.		<ul style="list-style-type: none"> ● Check whether the pipeline is connected well. ● Check whetehr all parts and connection wires are connected well. ● If there's no problem after checking, install front and rear cover plates.

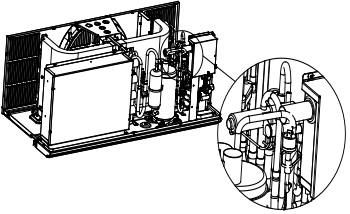
Removal operation for 4-way valve		
Remark: Before removing the 4-way valve, please make sure that there's no refrigerant inside the pipeline of system and then power is disconnected.		
Process	Photo	Operation Instruction
(1) Disconnect the coil of 4-way valve from the 4-way valve. (2) Disconnect the 4-way valve and connection pipeline.		<ul style="list-style-type: none"> ● Remove the coil of 4-way valve at first. ● Weld those 4 connection spots on 4-way valve, and then pull out the connection pipeNote: During welding process, do not let the flae burn out other parts.

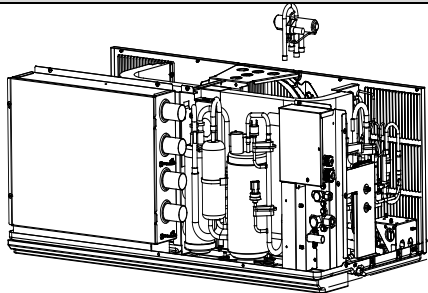
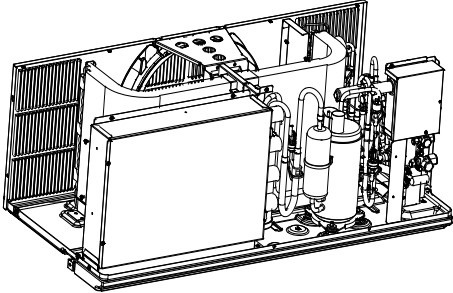
Removal operation for 4-way valve		
Remark: Before removing the 4-way valve, please make sure that there's no refrigerant inside the pipeline of system and then power is disconnected.		
Process	Photo	Operation Instruction
(3) Replace 4-way valve.		<ul style="list-style-type: none"> ● Replace 4-way valve Note: During welding process, do not let the flame burn out other parts.
(4) Replace 4-way valve.		<ul style="list-style-type: none"> ● Weld the connection position between 4-way valve and pipeline Note: During welding process, do not let flame burn out other parts.

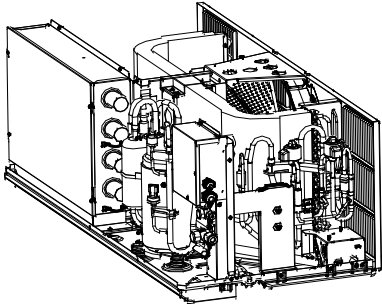
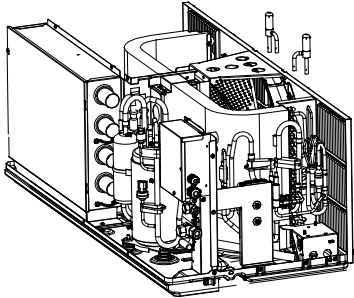
Removal operation for electronic expansion valve.		
Remark: Before removing the electronic expansion valve, please make sure that there's no refrigerant in the pipeline of system and the power is disconnected.		
Process	Photo	Operation Instruction
(1) Disconnect the electronic expansion valve from the pipeline.		<ul style="list-style-type: none"> ● Remove the coil of electronic expansion valve at first. ● Weld the connection pipe for expansion valve, and then pull out the connection pipe. Note: During welding process, do not let flame burn out other parts.
(2) Take out the electronic expansion valve and replace it.		<ul style="list-style-type: none"> ● Take out the electronic expansion valve and replace it.

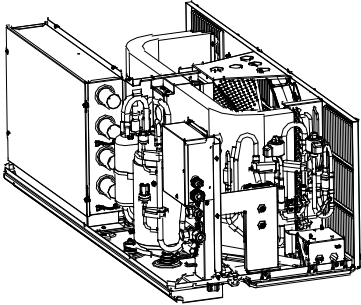
Removal operation for electronic expansion valve.		
Remark: Before removing the electronic expansion valve, please make sure that there's no refrigerant in th pipeline of system and the power is disconnected.		
Process	Photo	Operation Instruction
(3) Replace electronic expansion valve.		<ul style="list-style-type: none"> ● Weld the connection pipe of electronic expansion valve. ● Ininstall the coil of electronic expansion valve <p>Note: During welding process, do not let the flame burn out other parts.</p>

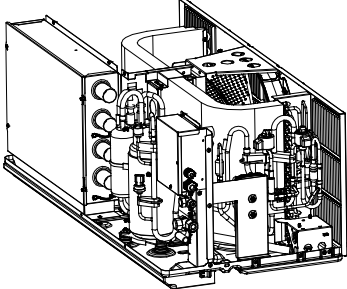
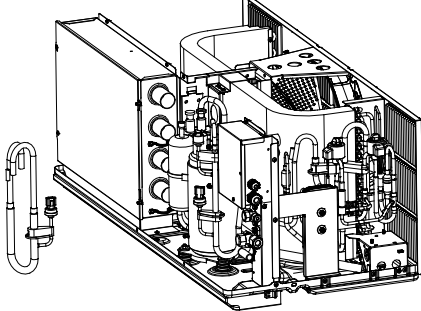
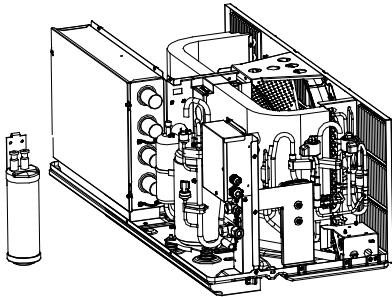
Removal operation of gas liquid separator		
Remark: Before removing the gas liquid separator, please make sure that there's no refrigerant inside the pipeline of system and disconnect the power		
Process	Photo	Operation Instruction
(1) Disconnect inlet pipe and exit pipe of gas liquid separator.		<ul style="list-style-type: none"> ● Weld those two connection spots on the gas liquid separator and then pull out the connection pipe <p>Note: During welding process, do not let flame burn out other parts.</p>
(2) Take out the connection pipe		<ul style="list-style-type: none"> ● Take out the connection pipe.
(3) Replace gas liquid separator.		<ul style="list-style-type: none"> ● Loose 2 screws with screwdriver. ● Replace gas lliquid separator.

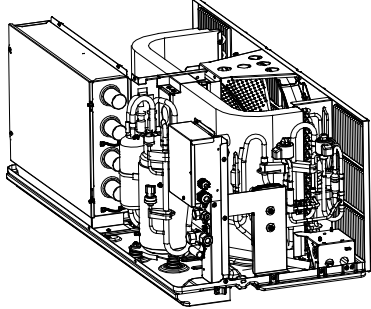
Removal operation of gas liquid separator		
Remark: Before removing the gas liquid separator, please make sure that there's no refrigerant inside the pipeline of system and disconnect the power		
Process	Photo	Operation Instruction
(4) Replace gas liquid separator.		<ul style="list-style-type: none"> ● Weld the pipe connected with gas liquid separator. ● Fix the screws at the base of gas liquid separator well again <p>Note: During welding process, do not let flame burn out other parts.</p>

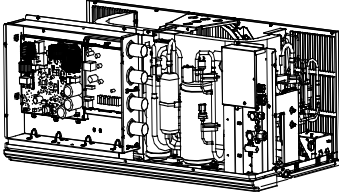
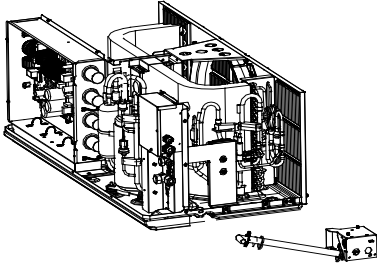
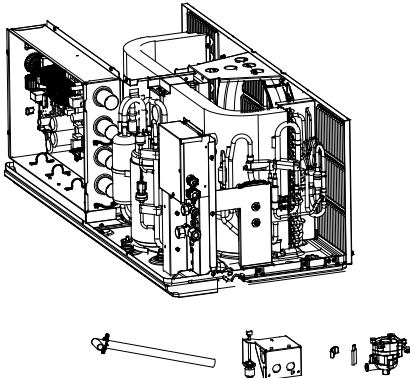
Remove water pump.		
Remark: Before removing the water pump, please make sure that the unit is disconnected with the power.		
Process	Photo	Operation Instruction
(1) Remove water pump and screw fixing the drainage pipe sub-assy.		<ul style="list-style-type: none"> ● Loose the power cord for the water pump and the electric heating of water pump. ● Loose the screws fixing the water pump support and the drainage pipe with a screwdriver.
(2) Take out the water pump and the drainage pipe sub-assy.		<ul style="list-style-type: none"> ● Take out the water pump and the drainage pipe sub-assy.
(3) Replace water pump.		<ul style="list-style-type: none"> ● Loose screws fixing the water pump with a screwdriver. ● Loose screw fixing the electric heating belt of water pump with a screwdriver and then remove the electric heating element of water pump. ● Replace the water pump. ● Install the electric heating element and drainage pipe of water pump.

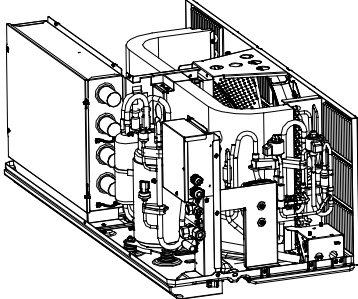
Remove water pump.		
Remark: Before removing the water pump, please make sure that the unit is disconnected with the power.		
Process	Photo	Operation Instruction
(4) Replace water pump.		<ul style="list-style-type: none"> ● Install the water pump and the drainage pipe sub-assy. ● Connect the power cord for the water pump and the electric heating of water pump.

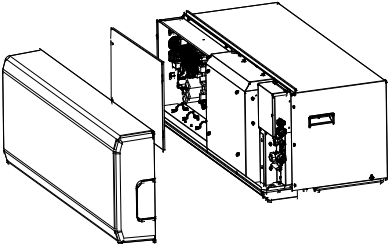
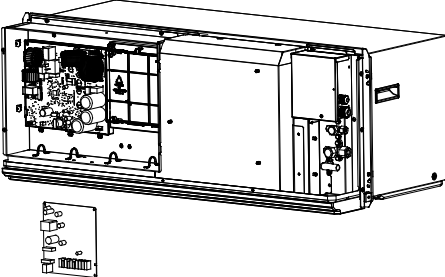
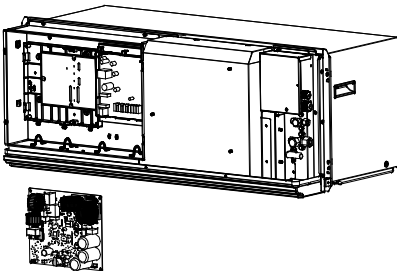
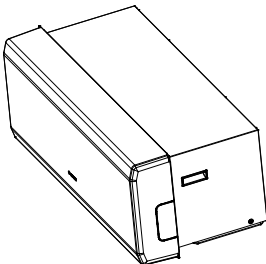
Remove electric box		
Remark: Before removing the electric box, please make sure that the unit is disconnected with the power.		
Process	Photo	Operation Instruction
(1) Remove front side plate and electric box cover.		<ul style="list-style-type: none"> ● Loose spring clasps at both ends of panel; ● Remove screws fixing the electric box with a screwdriver, and then remove the electric box cover.
(2) Remove main board.		<ul style="list-style-type: none"> ● Pull the wires of main board. ● Remove the screws fixing the main board and then remove the main board. ● Replace the main board and then tighten the screws. ● Connect the wires of main board according to the wiring diagram.
(3) Replace drive board.		<ul style="list-style-type: none"> ● Pull the wires on the drive board. ● Twist off screws fixing the drive board and then remove the driven board. ● Replace the drive board and then tighten the screws. ● Connect the wires of drive board according to the wiring diagram.
(4) Check and open the upper cover plate.		<ul style="list-style-type: none"> ● Check whether the pipeline is connected well. ● Check whetehr all parts and connection wires are connected well. ● If there's no problem after checking, install front and rear cover plates.

5 Common Maintenance

5.1 Vacuum Drying for the System

5.1.1 Selection Requirement for the Vacuum Pump

Do not use different vacuum pump for vacuum-pumping for different refrigerant system.

The final vacuum for the vacuum pump should reach -0.1MPa .

The air discharge volume for the vacuum pump should reach 4L/S above.

The precision of vacuum pump should reach 0.02mmHg above.

The system vacuum pump for R410A must be with check valve.

5.1.2 Operation Procedure and Notices for Vacuum Drying

(1) Operation procedure.

- 1) Before vacuum-pumping, please confirm that the cut-off valve for gas pipe and liquid pipe is at off status.
- 2) Use charging conduct pipe to connect the governing valve and vacuum heat pump to the detection joint of gas valve and liquid valve.
- 3) After vacuum-pumping for 4h, check whether the vacuum degree is reached to -0.1MPa or above; If not, there may be gas leakage. Please perform the leakage inspection again. If there's no gas leakage, please vacuum pump for another 2h.
- 4) If the required vacuum degree can't be satisfied after vacuum-pumping for two times, there are water inside the pipeline. Please drain out the water by the method of vacuum damage. The detailed method: charge 0.05MPa nitrogen into the pipeline, vacuum pump for 2h and then keep the vacuum for 1h. If -0.1MPa vacuum degree still can't be reached, repeat this operation until the water is drained out completely.

(2) After the vacuum pump is finished, turn off the valve of governing valve and stop vacuum pump and keep it for 1h. Please confirm that the pressure of governing valve hasn't been increased.

- 1) Vacuum pump for the gas pipe and liquid valve at the same time.

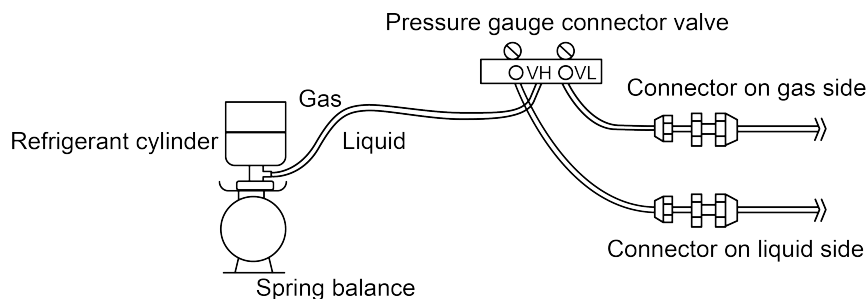

- 2) When turn off the vacuum pump to stop vacuum-pumping, please turn off the valve at first and then de-energize the vacuum pump.
- 3) Keep the vacuum pump for 2h and confirm that the pressure of vacuum meter hasn't been increased.

5.2 Fill and Charge Refrigerant

5.2.1 Filling Procedure of Refrigerant

Refrigerant quantity of outdoor unit before delivery:

Model	GMV-12WP/A-T(U)
Refrigerant Qty (kg/oz)	0.8 (28.2)

NOTICE

- (1) The refrigerant amount charged before delivery doesn't include the amount that needs to be added to indoor units and the connection pipeline.
- (2) Length of connection pipe is decided on site. Therefore the amount of additional refrigerant shall be decided on site according to the dimension and length of field-installed liquid pipe.
- (3) Record the amount of additional refrigerant for convenience of after-sales service.

Calculation of the amount of additional refrigerant see part of 6.2.2 Refrigerant Adding.

5.3.2 Operation Procedure for Adding Refrigerant

- (1) Put the charging tank on the weightometer, record the reading and then calculate the data after charging refrigerant.
- (2) Use charging conduct pipe to connect the double-ended manometer with governing valve and liquid-charging tank to the detection head of gas valve and liquid valve. Before connection, please release some refrigerant and then drain out the air inside the charging conduct pipe.
- (3) Confirm that the gas valve and liquid valve for outdoor unit is at off status.
- (4) When the unit hasn't been turned on, open the governing valve for the liquid-charging tank and then charge refrigerant from gas pipe and liquid pipe at the same time.
- (5) Observe the data weightometer, close the valve after it is reached to requirement and then close the valve for liquid-charging tank.
- (6) If the refrigerant can't be added completely, add it when turning on the unit. Charge refrigerant from the detection joint of cooling gas pipe or detection joint of gas valve.

5.2.3 Notice for Filling Refrigerant

- (1) Calculate the section and length of cooling liquid pipe precisely for the precision refrigerant-charging volume.
- (2) Measure the additional refrigerant volume precisely.
- (3) Invert to charge the R410A for ensuring the liquid-charging.
- (4) When the temperature is low, heat the liquid-storage tank with hot water or hot wind for helping refrigerant-charging. However, prohibit use flame to heat the liquid-storage tank directly. Otherwise, it may cause personal injury or property damage due to explosion.

5.3 Airtightness Test

5.3.1 Importance of Airtightness Test

The airtightness of VRF system is the leak tightness of the pipeline for refrigerant, which the guarantee for safe and reliable operation. The leakage of refrigerant may affect the operation of air

conditioner seriously, or even damage compressor and then lead to breakdown of system. Therefore, it needs to perform the airtightness test. If there's gas leakage after the system is installed completely, because the indoor ceiling decoration are all finished, it's will be very difficult to find out the leakage point. Thus, the airtightness test of the system must be finished before finishing indoor decoration.

5.3.2 Operation Procedure for the Airtightness Test

Before ex-factory, cut-off valve for gas pipe and liquid pipe of outdoor unit is turned off. Please confirm that before operation.

Before testm please smear a little corresponding lubricant oil at Blanking plug. and pipe terminal, and use two wrenches for fixing Blanking plug.

Do not allow to connect the pipeline of outdoor unit for test during airtightness test.

The system test pressure for R410A is 4.15MPa (3.0MPa for R22 refrigerant system). Nitrogen must be used as the medium for the airtightness test and the nitrogen should be dry. Increase pressure slowly for three steps:

Step 1: Increase pressure slowly to 0.5MPa, stop for 5min and then check the gas leakage. Big leakage may be found out;

Step 2: Increase pressure slowly to 1.5MPa, stop for 5min to check the airtightness. Small leakage may be found out;

Step 3: Increase pressure slowly to 4.15MPa for R410A slowly (3.0MPa for R22 refrigerant system), stop for 5min and perform the strength test. Minor leakage or sand hole may be found. Increase pressure to test pressure, keep it for 24h and observe whether the pressure is decreasing. If not, the pressure is qualified.

5.3.3 Cautions

- (1) The test manometer range for R410A should be 4.5MPa above (3.5MPa above for R22 refrigerant system).
- (2) Record the data on manometerk, ambient temperature and test time at the same time;
- (3) Pressure modification: when temperature changes 1°C, the temperature will change 0.01MPa correspondingly.
- (4) Pressure should be kept the same.
- (5) If it needs to keep pressure for a long time, decrease the pressire lower than 0.55MPa pr below. Long-time high pressure can lead to leakage at the welding position, which may cause riskl.
- (6) Before the airtightness for the pipeline of refrigerant is finished, do not allow to insulate and bundle the welding positions and connection position of bellmouth of indoor unit.

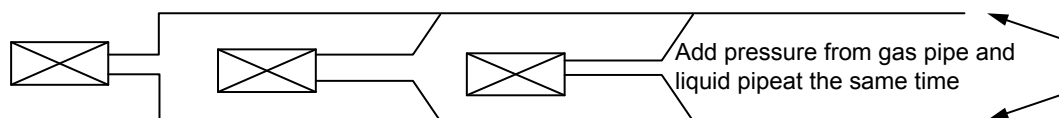

NOTICE! Before airtightness test, all welding lines can't be insulated and bundled.

6 Exploded View of Unit and Parts' List

Exploded view for outdoor unit and parts' list.

(1) Model: GMV-12WP/A-T(U)

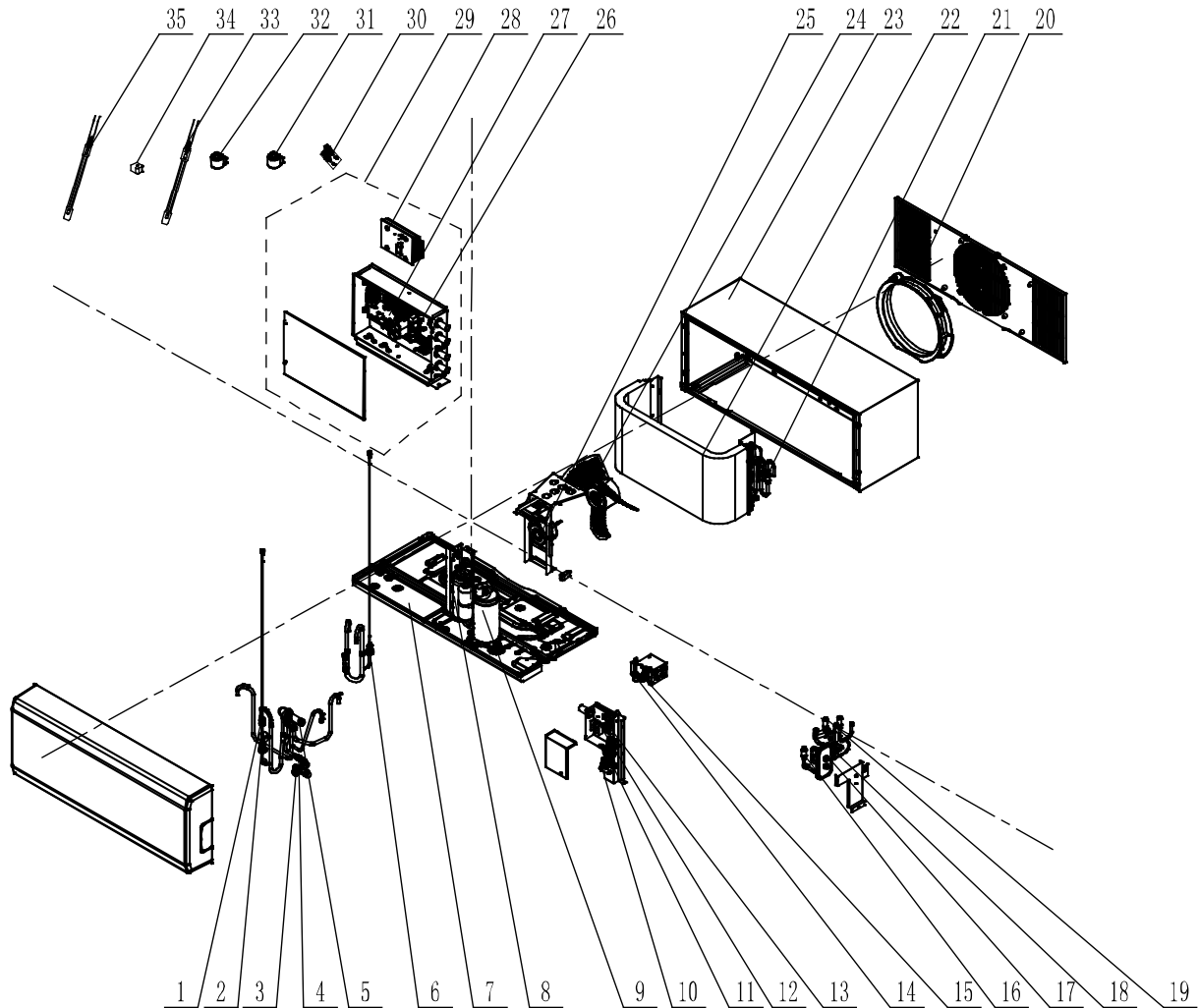

Parts list

NO.	Name of Part	GMV-12WP/A-T(U)	
		Product Code	CN850W0930
1	Pressure Protect Switch	46020006	1
2	Pressure Sensor	430044000015	1
3	Cut off Valve	07304100015	1
4	Strainer	0721212101	1
5	4-Way Valve	430004032	1
6	Pressure Sensor	430044000016	1
7	Chassis Assy	209058060135	1
8	Gas-Liquid Separator	07223048	1
9	Compressor and Fittings	00103873	1
10	Drainage Joint	200038060002	1
11	Cut off Valve	070001000004	1
12	Terminal Board	422000060004	1
13	Terminal Board	422000000015	1

NO.	Name of Part	GMV-12WP/A-T(U)	
		Product Code	CN850W0930
14	Liquid Level Switch	43002400000503	1
15	Water Pump	812007060052	1
16	Strainer	07213050	1
17	Plate-Type Heat Exchanger	010007060010	1
18	Discharge Charge Valve	07133771	1
19	Electronic Expansion Valve	072009000001	1
20	Diversion Circle	200150060011	1
21	Strainer	0741520000201	1
22	Condenser Assy	011002060511	1
23	Cabinet Assy	000006060026	1
24	Axial Flow Fan	10333002	1
25	Brushless DC Motor	1501308522	1
26	Main Board	300027060516	1
27	Main Board	300027060543	1
28	Radiator	430034060054	1
29	Electric Box Assy	100002065729	1
30	Sensor Sub-Assy	390002060093	1
31	Electric Expand Valve Fitting	4304413262	1
32	Electric Expand Valve Fitting	4304413271	1
33	Electrical Heater(Compressor)	7651350201	1
34	4 Way Valve Coil	4300040095	1
35	Electrical Heater (Chassis)	7651000420	1



GREE ELECTRIC APPLIANCES, INC. OF ZHUHAI 519070

Add: West Jinji Rd, Qianshan Zhuhai, Guangdong, China

Tel: (+86-756)8522218

Fax: (+86-756)8669426

E-mail: gree@gree.com.cn www.gree.com

JF00304109