



# **Owner's Manual**

## **Original Instructions**

### **E-Smart Zone Controller**

Model:

CE54-24/F(C)

Thank you for choosing this product. Please read this Owner's Manual carefully before operation and retain it for future reference.

If you have lost the Owner's Manual, please contact the local agent or visit [www.gree.com](http://www.gree.com) or send an email to [global@gree.com.cn](mailto:global@gree.com.cn) for the electronic version.

GREE ELECTRIC APPLIANCES, INC. OF ZHUHAI

## To Users

Thank you for selecting Gree's product. Please read this instruction manual carefully before installing and using the product, so as to master and correctly use the product. In order to guide you to correctly install and use our product and achieve expected operating effect, we hereby instruct as below:

- (1) This appliance is not intended for use by persons (including children) with reduced physical, sensory or mental capabilities, or lack of experience and knowledge, unless they have been given supervision or instruction concerning use of the appliance by a person responsible for their safety. Children should be supervised to ensure that they do not play with the appliance.
- (2) This instruction manual is a universal manual, some functions are only applicable to particular product. All the illustrations and information in the instruction manual are only for reference, and control interface should be subject to actual operation.
- (3) In order to make the product better, we will continuously conduct improvement and innovation. We have the right to make necessary revision to the product from time to time due to the reason of sales or production, and reserve the right to revise the contents without further notice.
- (4) For personal injury or property loss and damage caused by improper operation such as improper installation and debugging, unnecessary maintenance, violation of related national laws and rules and industrial standard, and violation of this instruction manual, etc., we will bear no liability.
- (5) The final right to interpret for this instruction manual belongs to Gree Electric Appliances Inc. of Zhuhai.

# Contents

<b>1 Safety Notices (Please be sure to abide them)</b> .....	<b>1</b>
<b>2 User Notice</b> .....	<b>1</b>
<b>3 Installation Instructions</b> .....	<b>2</b>
3.1 Installation Requirements.....	4
3.2 Wiring Instructions .....	4
3.3 Installation Procedures.....	9
3.4 Removal Procedures.....	10
<b>4 Display and Operation Instructions</b> .....	<b>10</b>
4.1 Main Page Display and Buttons .....	11
4.2 General Buttons .....	12
4.3 Buttons Operation Instructions .....	12
<b>5 Functions Description</b> .....	<b>13</b>
5.1 All ON/OFF .....	13
5.2 Single Unit Control .....	13
5.3 Group Control .....	16
5.4 Local Setting .....	17
5.5 Engineering Setting.....	18
5.6 Operation Notice .....	19

## 1 Safety Notices (Please be sure to abide them)



**WARNING:** If not abide them strictly, it may cause severe damage to the unit or the people.



**NOTE:** If not abide them strictly, it may cause slight or medium damage to the unit or the people.



This sign indicates that the items must be prohibited. Improper operation may cause severe damage or death to people.



This sign indicates that the items must be observed. Improper operation may cause damage to people or property.



### **WARNING!**

This product can't be installed at corrosive, inflammable or explosive environment or the place with special requirements, such as kitchen. Otherwise, it will affect the normal operation or shorten the service life of the unit, or even cause fire hazard or serious injury. As for the above special places, please adopt special air conditioner with anti-corrosive or anti-explosion function.

## 2 User Notice

- ◆ All indoor units must be supplied with unified power.
- ◆ Make sure communication cord is connected with the proper port, otherwise there may occur communication malfunction.
- ◆ Never knock on, throw or frequently detach the centralized controller.
- ◆ Never operate the centralized controller with wet hands.
- ◆ Never scratch the screen of centralized controller by hard or sharp objects.
- ◆ If the centralized controller is connected with the ODU network or the last indoor unit of the IDU network, then a matching resistance must be connected between G1 and G2 ports.
- ◆ All photos in this manual is only for reference, please refer to the actual product for the final effect.

### 3 Installation Instructions

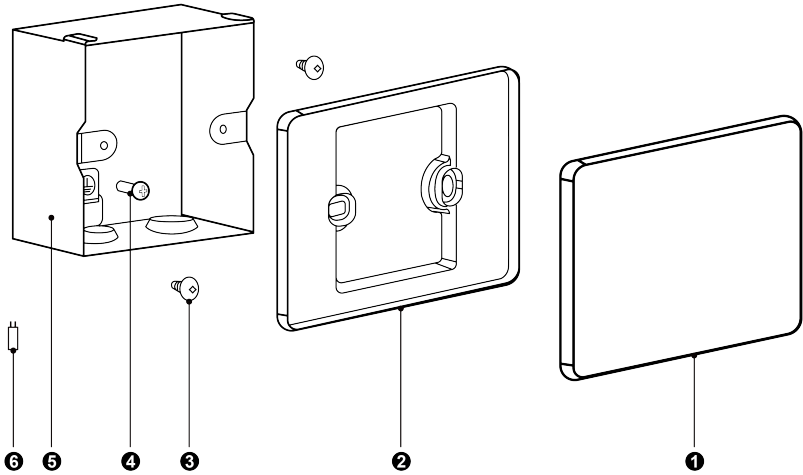

Fig.3.1 Parts of Centralized Controller

No.	①	②	③	④
Name	Touch screen of controller	Rear cover of controller	Self-tapping screw ST4.2×9.5 MC (Used to secure the rear cover of controller)	Screw M4×12 (used to secure ground wire)
QTY	1	1	2	1
No.	⑤	⑥	—	—
Name	Wiring box installed in wall	Matching resistance	—	—
QTY	1	1	—	—

Unit: mm

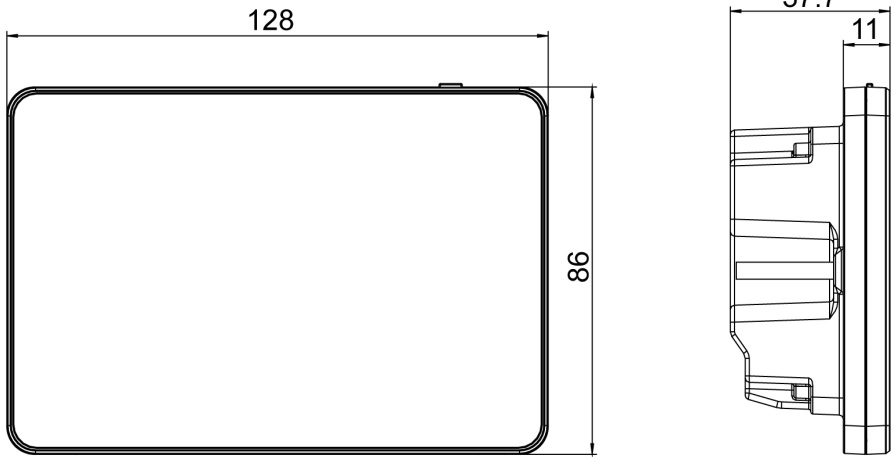

Fig.3.2 Dimension of Centralized Controller

Unit: mm

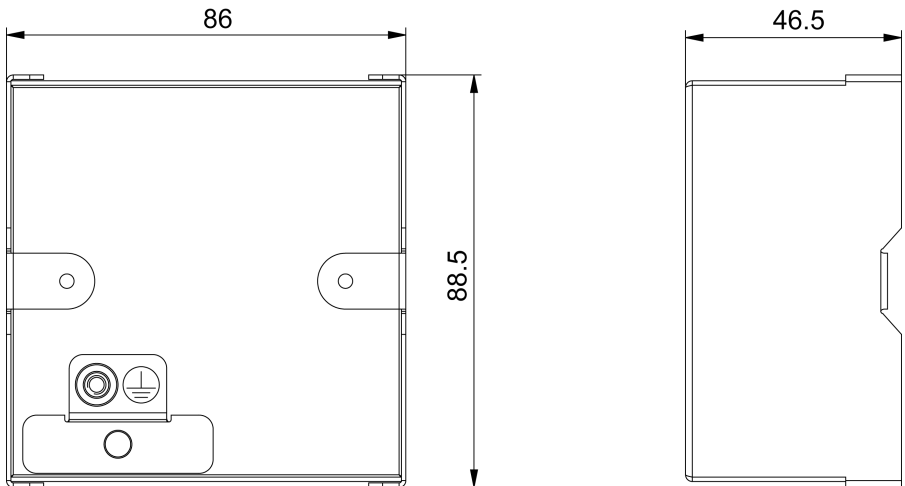

Fig.3.3 Dimension of Wiring Box Installed in Wall

### 3.1 Installation Requirements

Communication cord of the centralized controller must be selected according to the table below. Never use the cable that is not in compliance with instructions of this manual.

Network	Cord type	Cord standard	Cord size (mm <sup>2</sup> /AWG)	Total length L(m/feet)	Remark
Indoor network	Light/ Ordinary polyvinyl chloride sheathed cord. (60227 IEC 52 /60227 IEC 53)	IEC 60227- 5:2007	2×0.75~2×1.25 (2×AWG18~2×AWG16)	L≤1000m (L≤3280-5/6feet)	If cord size is 2×1mm <sup>2</sup> (2×AWG16), communication cord can be stretched longer. But the total length can't exceed 1500m(4921-1/4feet).
Outdoor network				L≤500 (L≤820-1/5feet)	Total length of communication cord can't exceed 500m(820-1/5feet).



**NOTES:**

- ① The cord should be Circular cord (the cores should be twisted together).
- ② If unit is installed in places with intense magnetic field or strong interference, it is necessary to use shielded wire.
- ③ Never install the centralized controller in the following places:
  - a) Places with corrosive gas or serious dust, salt mist or oil smoke.
  - b) Wet and damp places or places with direct sunlight.
  - c) Places near high temperature objects or places where units might be splashed by water.

### 3.2 Wiring Instructions

#### 3.2.1 Wiring Ports

Port print	G1、G2	F1、F2	L、N
Meaning	CAN communication port	<b>【Reserved】</b>	Power port

### 3.2.2 Power Supply

- (1) The centralized controller should use independent power supply.
- (2) The range of input voltage: 100~240VAC; Frequency range: 50/60Hz.
- (3) Maximum rated power: 3W.
- (4) The supply cord of this control can be replaced only by the manufacturer or his accredited service agent.
- (5) Select power cord according to the following table. Never use the power cord that is not in compliance with instructions of this manual.

Cord type	Cord standard	Cord size (mm <sup>2</sup> )
Single-core soft conductive unsheathed cord(60227 IEC 08)	IEC 60227-3 2007	1.5

### 3.2.3 Connection Method

There are three methods to connect centralized controller with the air conditioning system:

Method 1: Connect with IDU network

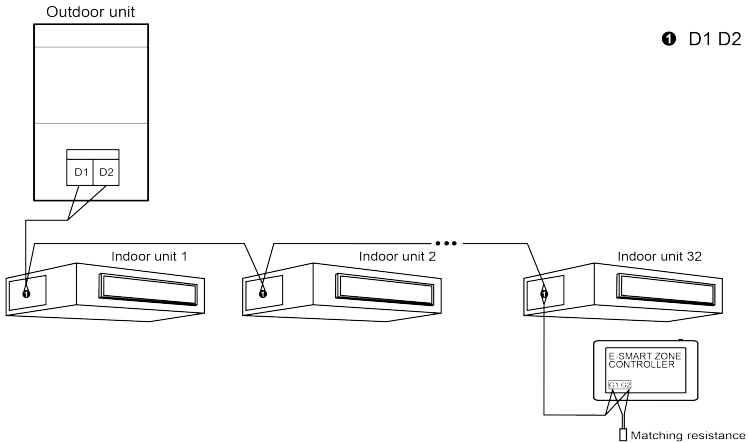

Fig.3.4 Centralized Controller Connected with IDU Network



Method 2: Connect with ODU network

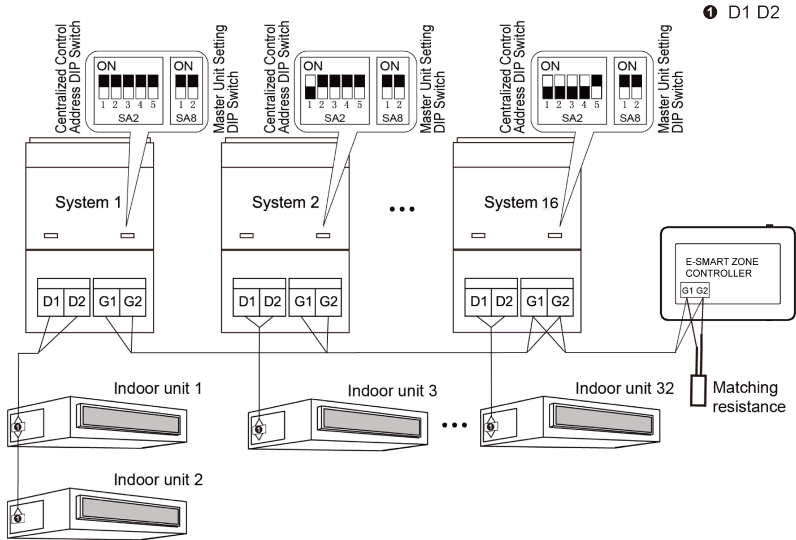

Fig.3.5 Centralized Controller Connected with ODU Network

Method 3: Connect with heat recovery mode converter network

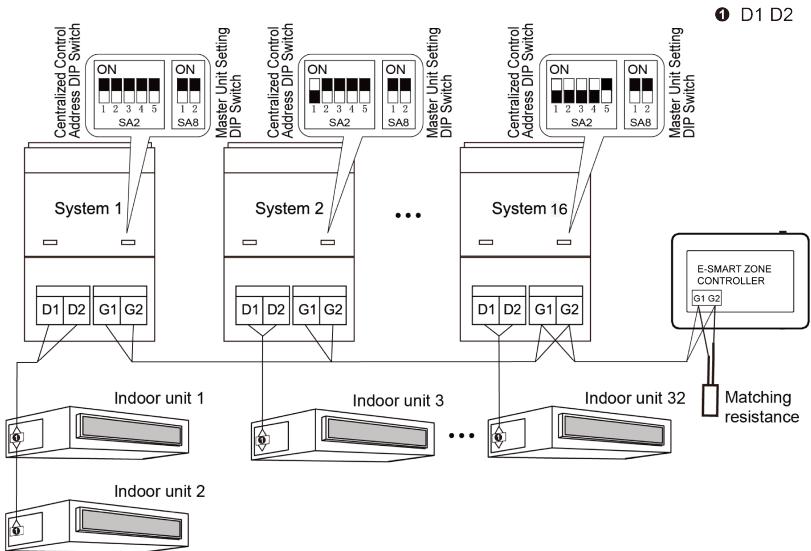

Fig. 3.6 Centralized Controller Connected with Heat Recovery Mode Converter Network

### Wiring Instructions:

- (1) The smart centralized controller is applicable to multi VRF units, connectable with IDU network, ODU network or mode converter network. One centralized controller can control up to 16 sets of outdoor unit system and up to 32 sets of indoor unit.
- (2) If the centralized controller is to be connected with the IDU network, connect according to Fig.3.4. The controller can connect with any one indoor unit in series, that is, connect the controller's G1 and G2 ports with the D1 and D2 ports correspondingly with communication wires. When the controller is connected with the terminal unit of IDU network, a matching resistance needs to be added with the communication wires at the G1 and G2 ports.
- (3) If the centralized controller is to be connected with the ODU network, connect according to Fig.3.5. The centralized controller can only be connected with the terminal system of the ODU network. A matching resistance needs to be added with the communication cords at the G1 and G2 ports.
- (4) The centralized control address DIP switch (SA2\_Addr-CC) indicates the centralized control address required when different refrigerating systems are controlled in a centralized manner. The default factory setting is "00000".
- (5) If the centralized controller is to be connected with the heat recovery network, connect according to Fig. 3.6. The method 2 is also applicable to centralized controller connected with the heat recovery network.

If the centralized controller is to be connected with the ODU network, set the ODU centralized control address DIP switch according to the following methods:

- 1) The DIP switch must be set on the master outdoor unit and set the Master Unit Setting DIP Switch (SA8) to "00". Otherwise, the setting is invalid;
- 2) On the same refrigerating system, the centralized control address DIP switch on a non-master unit is invalid, and it is unnecessary to change the settings;
- 3) The centralized control address DIP switch on the master outdoor unit of a refrigerating system must be set to "00000", and this system is the master

## E-Smart Zone Controller

---

mode system;

- 4) The centralized control address DIP switch on the master unit of other refrigerating systems must be set as follows:

SA2					Address NO.
DIP1	DIP2	DIP3	DIP4	DIP5	
1	0	0	0	/	2
0	1	0	0	/	3
1	1	0	0	/	4
0	0	1	0	/	5
1	0	1	0	/	6
0	1	1	0	/	7
1	1	1	0	/	8
0	0	0	1	/	9
1	0	0	1	/	10
0	1	0	1	/	11
1	1	0	1	/	12
0	0	1	1	/	13
1	0	1	1	/	14
0	1	1	1	/	15
1	1	1	1	/	16

- 5) The centralized control address DIP switch cannot be the same between different refrigerating systems. Otherwise, address conflicts may occur and the unit cannot run properly.

### 3.3 Installation Procedures

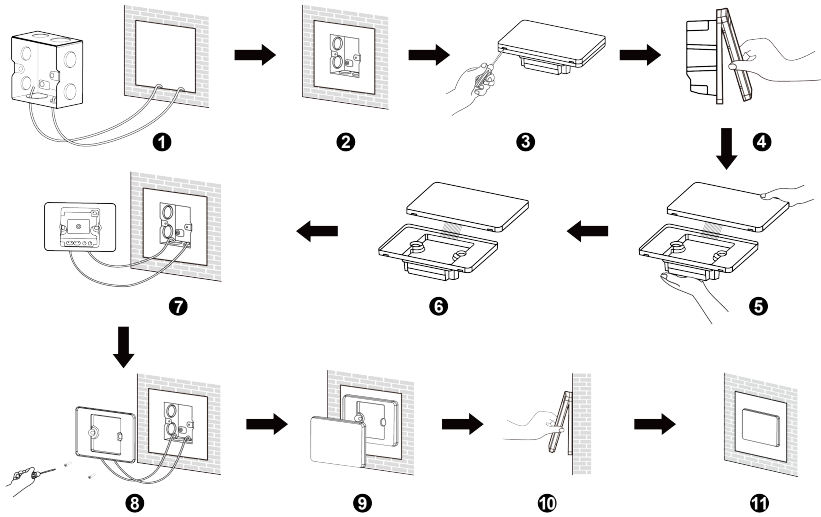

Fig.3.7 Installation Diagram

Fig.3.7 shows the simple installation procedures of centralized controller.

Please pay attention to the following matters:

- (1) Before installation, first cut off the power supply of indoor unit. The power must be cut off during the whole installation process.
- (2) During the installation, be careful not to damage the touch screen.
- (3) Before installation, please make the following preparations:
- (4) In case that the centralized controller is installed on wall, dig a installation hole with the size of 86mm×88.5mm×46.5mm on the wall.
- (5) In step ①, pull out the power core and communication wire, and then lead them separately from the wire orifice of the electric box rear cover. Never lead the cords through the same orifice.
- (6) In step ②, secure the wiring box on the wall.
- (7) In step ⑥, pull out the wire connecting the touch screen and controller's rear cover. Then put the touch screen on a safe place.
- (8) In step ⑦, connect the communication wire to G1,G2 terminals, and connect the neutral wire and live wire to the L, N terminal; connect the ground wire to position ⊕ on the electric box rear cover. Secure it with

screw M4×12.

- (9) In step ⑧, locate the controller's rear cover onto the wiring box with screw ST4.2×9.5MC.
- (10) In step ⑨, connect the wire between touch screen and controller's rear cover.

## 3.4 Removal Procedures

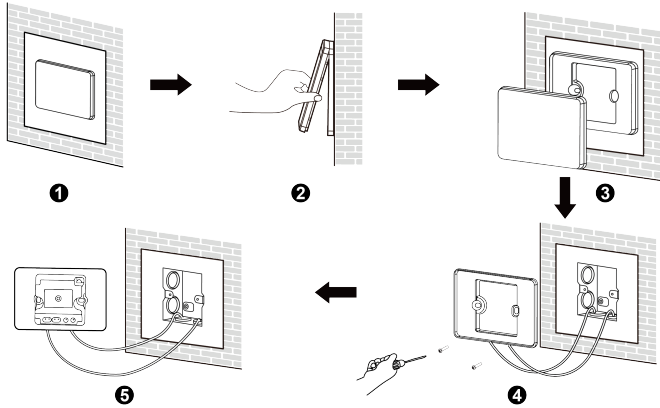

Fig.3.8 Diagram of Removal

## 4 Display and Operation Instructions

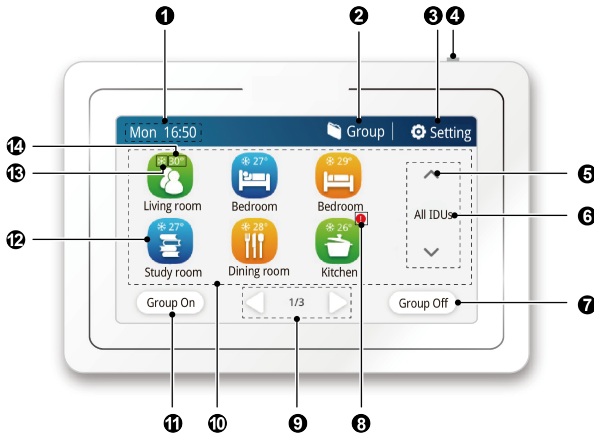





















Fig4.1 Main Page

## 4.1 Main Page Display and Buttons

No.	Name	Instructions
1	System time	When the controller is connected with communication network, current day, hour, minute, a.m./p.m.(12-hour clock);
2	Group entrance	Press this button to enter group list page for group control and editing, etc.
3	Setting entrance	Press this button to enter setting page for local setting and engineering setting, etc.
4	Touch button	Press the Touch Button to turn on/off the screen of E-Smart Zone Controller; Press and hold the Touch Button for 5sec to reset the E-Smart Zone Controller.
5	Area switch	Press the Touch Button to switch area;
6	Area name	Current area name;
7	Group OFF button	Press this button once to turn off current zone indoor units in current area.
8	Icon of master IDU, error or shield status	When this indoor unit is master IDU, or with error or is shielded, the corresponding icon will be displayed if one of the three status is valid. The display priority is: master IDU-error-shield.
9	Page index	Under current status, when the IDU quantity exceeds the quantity that can be displayed in a page, sliding left or right can turn over the page.
10	IDU display	Display in separate page the list of indoor units that are controlled by the E-Smart Zone Controller. Sliding left or right can turn over the page.
11	Group ON button	Press this button once to turn on current zone indoor units in current area.
12	IDU icon	Press the button to enter the page of indoor unit control. Grey icon indicates that IDU is off.
13	Operation mode icon	When indoor unit is on, the current operation mode will be displayed:  Auto  Cooling  Dry  Fan  Heating  Floor heating  Heat supply  3D heating
14	Set temperature icon	When indoor unit is on, set temperature will be displayed here.

## 4.2 General Buttons

Display	Name	Meaning	Display	Name	Meaning
	Return	Press this button to return to the previous page		Option	Option is selected/not selected
	Page up	One page up		Page down	One page down
	Add	Press this button to add group		Edit	Press this button to edit the group
	Reduce	Press this button to decrease value		Increase	Press this button to increase value
	Left	Press this button to decrease value		Right	Press this button to increase value
	Down	Press this button to decrease value		Up	Press this button to increase value

## 4.3 Buttons Operation Instructions

The centralized controller uses a capacitive touch screen so that user can operate the units by just touching the screen.

Buttons on the screen are presented in the following ways:

(1) Icon

Icon button can be operated directly. See section 4.2 for more details.

(2) Text

Press Text button to enter corresponding page; (take IDU parameter setting page as an example):

**Filter Dirty Alarm** Press it to enter parameter setting of this item;

(3) Icon + Text

According to the meaning of Text, select a certain function or enter a certain page. (take sound setting as an example):

 **Sound** Press it to enter sound setting page;

(4) Zone button

On the timer page, as indicated in Fig.4.2, each rectangle frame constitutes a zone button.

Press the zone button, timer setting page will pop in.



Fig.4.2 Page of Timer List

## 5 Functions Description

### 5.1 All ON/OFF

On the home page, press “Group Off” button to turn off all indoor units.

Press “Group On” button to turn on all indoor units. Then indoor units will work according to memory.

### 5.2 Single Unit Control

On the home page, press the icon of indoor unit to enter the single unit control.

Parameters of single unit control include parameters of general control and advanced control.

#### 5.2.1 General Control Parameters

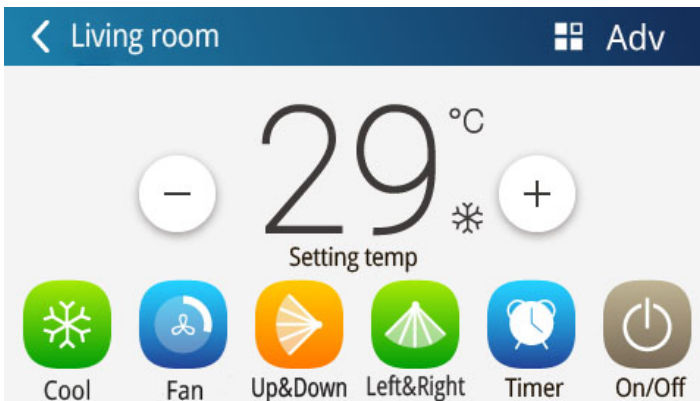

Fig.5.1 Page of Single IDU Control



### (1) On/off

Press the on/off button to turn unit on or off.

When unit is turned off, mode, temperature, fan speed and swing can't be set.

### (2) Mode setting

Press the Mode buttons to set unit's operation mode.

Modes for indoor units of different series are not all the same. If a certain mode is not available for the indoor unit, the icon of the corresponding mode cannot be selected.

### (3) Temperature setting

Press the up or down buttons to adjust temperature. Each time pressing the button will increase/decrease the temperature by 1°C/°F.

Touch the temperature value zone (figure "29" as shown in Fig. 5.1) can switch to display "indoor temp". The corresponding indoor temperature value will be displayed.

### (4) Fan speed setting

Press fan speed button to set unit's fan speed.

**NOTE:** Unit defaults to low fan speed in dry mode. Fan speed cannot be set in dry mode or floor heating mode.

### (5) Swing setting

Pressing the button "Left & Right" or "Up & Down" or can turn on or off the swing function.

**NOTE:** Swing types for indoor units of different series are not all the same.

### (6) Malfunction view

When indoor unit fails to function well, press  **Error** to view the information of malfunctions.

## 5.2.2 Advanced Control Parameters

Press Advance Button to enter the advance page.

Press icon buttons to turn on or off the corresponding function.

(1) Functions of Sleep, Quiet, Auto Quiet, E-Heater, Absence, Rapid and Energy Saving can only be effective when unit is turned on.

(2) When sleep function is on, quiet function will be turned on subsequently. Sleep function will not be effective under auto, fan or floor heating mode.

(3) Absence function can only be turned on in heating mode. When absence

function is on, set temperature is 8°C.

- (4) Rapid cooling function can only be effective in cool mode. Likewise, rapid heating function can only be effective in heat mode.
- (5) When shield all function is on, other shield buttons will be invalid.

**NOTE:** When the centralized controller matches different air conditioning units, some functions will vary.



Fig.5.2 Advance Page

### 5.2.3 Timer Setting

Press timer button to enter timer setting list page (Fig. 4.2).

Press timer option zone button of timer list (timer ON/OFF, set information repeatedly) to enter timer editing page;

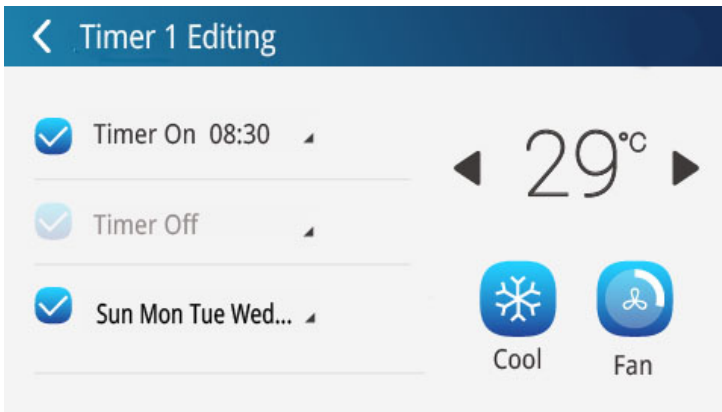

Fig. 5.3 Timer Editing Page

(1) Setting of timer mode, fan speed and set temperature;

The same as single unit control;

(2) Setting of timer ON/OFF time

Click "Timer On \*\*:\*\*" zone button to enter the setting page of timer on time for setting timer on time;

Press "Timer Off \*\*:\*\*" zone button to enter the setting page of timer off time for setting timer off time;

(3) Timer repeat setting

Press repeat zone button to enter timer repeat setting page for repeat setting;

**NOTE:** after finishing timer on, timer off and repeat setting, press  button before each option icon for activating or cancelling the option;

### 5.3 Group Control

Press the Group button on the home page to enter the page of group function.

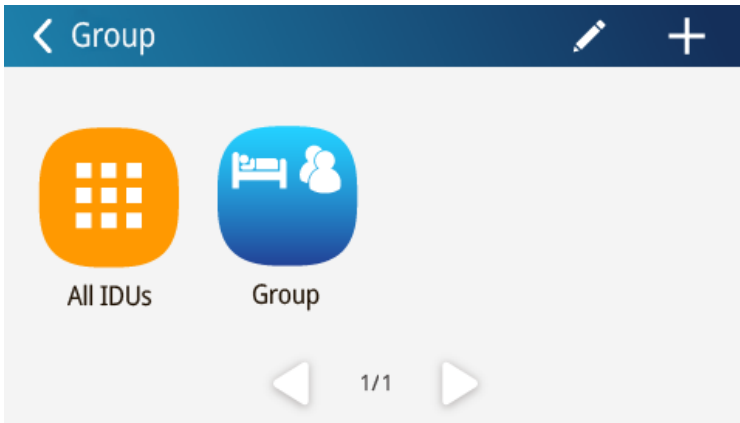



Fig.5.4 Group Page

Press the icon button (All IDU or blue icon button) to enter the page of group control. Control parameters are the same as single unit control.

Press  to send out the group control order.

(1) Edit group

Press  to enter the page of group editing.

Press the group needs to be edited and enter the group editing page. User can set the group name and add indoor units to the group.

Press Save button to save the setting.

**NOTE:** One set of indoor unit can be set in up to 5 groups.

(2) Add group

Press **+** to add new groups. Then the page of group editing will pop in.

User can set the group name and add indoor units to the group.

(3) Delete group

Press Delete button to delete the selected group.

## 5.4 Local Setting

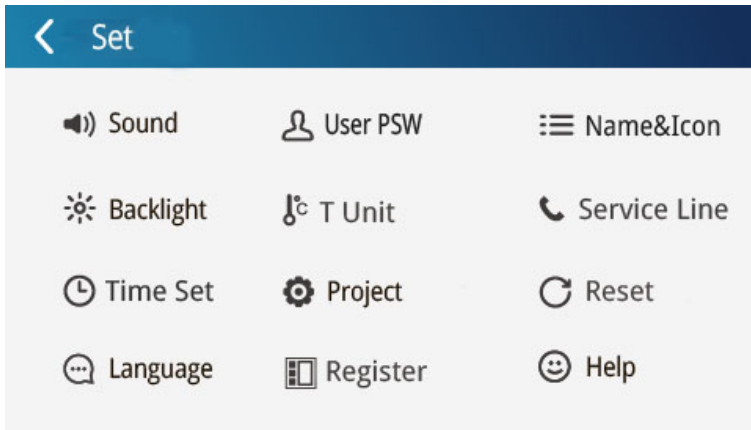

Fig.5.5 Setting Page

Press Setting on the home page to enter the setting page.

**Project** is set by professional engineering staff; other settings can be set by the user.

Local setting includes:

(1) Sound, language, temperature unit

Press the button to select one kind of setting.

(2) Time setting

1)Set time format: either 12hr clock or 24hr clock.

2)Set the date and time of the centralized controller system.

(3) User password

Press the button can activate or inactivate user password.

When password is activated, it can be set or changed in 6~10 numbers or characters.

Press the Save button to save the password.

**NOTE:** If user password is activated, user needs to input password to enter the control page when centralized controller is turned on or activated.

### (4) Backlight setting

Pressing this button can set the timeout period of screen backlight. Screen will be shut off and the centralized controller will enter sleep mode when the timeout period is over.

Pressing backlight degree  or  can adjust the backlight degree.

**NOTE:** When centralized controller is in sleep mode, user can wake it up by touching any part of the touch screen or the touch button at the right upper button of the screen.

### (5) Customer Service

User can set the name and phone number of the local customer service center for the convenience of acquiring immediate solutions and technical support.

Press Save button to save the setting.

### (6) Restore default settings

Press  button to restore local setting, group setting, schedule setting, names and icons of indoor units, and other relevant ex-factory default settings.

- 1) When switching between CAN1 and CAN2, or reset unit IP, restore the ex-factory setting for centralized controller.
- 2) After debugging for the centralized controller is finished, connect it to the network. If connect the centralized controller to the network during debugging process, it needs to restore the defaulted ex-factory setting.

## 5.5 Engineering Setting

On the home page, press setting to enter into setting interface.

### (1) Indoor unit register

Enter into the indoor unit register interface, select the chosen indoor unit according to the displayed engineering No. of indoor unit icon, and then press Confirm button to save, it will display the registered indoor unit on the home page.

**NOTE:** There are 32 sets of indoor units can be registered at most.

## (2) Name setting

Switch to indoor unit name setting interface to select the engineering No., and set the name and icon of indoor unit.

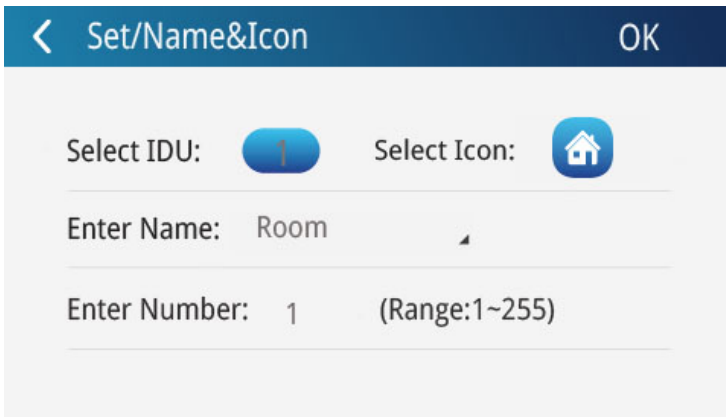



Fig. 5.6 Setting Page of Indoor Unit

Press  button to select the required indoor unit that needs to be set.

- (1) **Name:** number or letter can be input (it should not be over 15 letters).
- (2) **Icon:** press to select the preset icon.
- (3) **Engineering No.:** it can be set in 1-255.
- (4) Press Save button to successfully save the setting. Then the indoor unit list on the home page will display the new name and icon of indoor units.

## 5.6 Operation Notice

Press Setting on the homepage to enter the setting page.

Press  Help to enter help page and then press “  ” button to switch to operation notice.

On the page of operation notice, user can view the information of the local unit, customer service information, operation instructions and other notices.

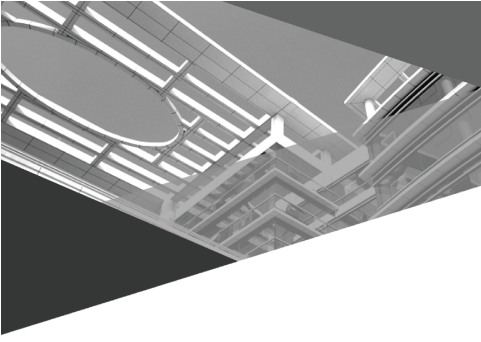

GREE ELECTRIC APPLIANCES, INC. OF ZHUHAI

Add: West Jinji Rd, Qianshan, Zhuhai, Guangdong, China, 519070

Tel: (+86-756) 8522218

Fax: (+86-756) 8669426

E-mail: [gree@gree.com.cn](mailto:gree@gree.com.cn) [www.gree.com](http://www.gree.com)



66170050061