



Owner's Manual

Original Instructions

Commercial Air Conditioners

Multi Variable Air Conditioners Duct Type Indoor Unit

Models:

GMV-ND05PLS/B1-T(U)

GMV-ND07PLS/B1-T(U)

GMV-ND09PLS/B1-T(U)

GMV-ND12PLS/B1-T(U)

GMV-ND14PLS/B1-T(U)

GMV-ND18PLS/B1-T(U)

GMV-ND24PLS/B1-T(U)

Thank you for choosing this product. Please read this Owner's Manual carefully before operation and retain it for future reference.

If you have lost the Owner's Manual, please contact the local agent or visit www.gree.com or send an email to global@cn.gree.com for the electronic version.

GREE ELECTRIC APPLIANCES, INC. OF ZHUHAI

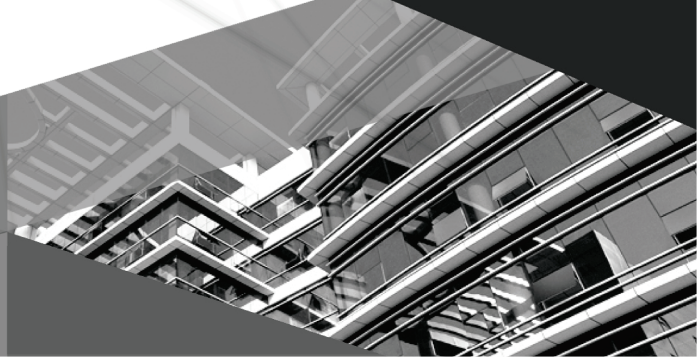

Preface

For correct installation and operation, please read all instructions carefully. Before reading the instructions, please be aware of the following items:

 WARNING
(1) Instructions for installation and use of this product are provided by the manufacturer.
(2) Installation must be performed in accordance with the requirements of NEC and CEC by authorized personnel only.
(3) For the safe operation of this unit, please read and follow the instructions carefully.
(4) During operation, total capacity of indoor units should not exceed the total capacity of outdoor units. otherwise, poor effect of cooling or heating may result.
(5) Direct operators or maintainers should well keep this manual.
(6) If this unit fails to operate normally, please contact our service center as soon as possible and provide the following information: 1) Content on the name plate (model number, cooling capacity, production code, ex-factory date). 2) Malfunction details (before and after the malfunction occurs).
(7) Each unit has been strictly tested and proved to be qualified before ex-factory. In order to prevent units from being damaged or operating normally because of improper disassembly, please do not disassemble the unit by yourself. If you need to disassemble and check units, please contact our service center. We will send specialists to guide the disassembly.
(8) All graphics in this manual is only for your reference. For sales or production reasons, these graphics are subject to change by manufacturer without prior notice.
(9) This appliance is not intended for use by persons (including children) with reduced physical, sensory or mental capabilities, or lack of experience and knowledge, unless they have been given supervision or instruction concerning use of the appliance by a person responsible for their safety. Children should be supervised to ensure that they do not play with the appliance.

User Notice



DISPOSAL: Do not dispose this product as unsorted municipal waste. Collection of such waste separately for special treatment is necessary.



Exception Clauses
Manufacturer will bear no responsibilities when personal injury or property loss is caused by the following reasons:
(1) Damage the product due to improper use or misuse of the product.
(2) Alter, change, maintain or use the product with other equipment without abiding by the instruction manual of manufacturer.
(3) After verification, the defect of product is directly caused by corrosive gas.
(4) After verification, defects are due to improper operation during transportation of product.
(5) Operate, repair, maintain the unit without abiding by instruction manual or related regulations.
(6) After verification, the problem or dispute is caused by the quality specification or performance of parts and components that produced by other manufacturers.
(7) The damage is caused by natural calamities, bad using environment or force majeure.

Contents

1 Safety Notices (Please be sure to abide them)	1
2 Product Introduction	2
2.1 Names of Key Components.....	2
2.2 Rated Working Condition.....	2
3 Preparations for Installation	2
3.1 Standard Fittings.....	3
3.2 Location for Installation.....	3
3.3 Requirements for Communication Line	4
3.4 Wiring Requirements	5
4 Installation Instructions	6
4.1 Installation of Indoor Unit.....	6
4.2 Pipe Connection	8
4.3 Installation and Test of Drain Pipe	9
4.4 Installation of Air Duct.....	12
4.5 Installation of Wired Controller	14
5 Wire Connection	14
5.1 Connection of Wire and Wiring Board Terminal.....	15
5.2 Power Cord Connection	16
5.3 Connection of Communication Line of IDU and ODU	16
5.4 Connection of Communication Line of Wired Controller.....	17
5.5 Instructions on Connecting Wired Controller and IDU Network.....	17
6 General Maintenance	19
6.1 Cleaning of Air Filter	19
6.2 Maintenance Before Use-season	19
6.3 Maintenance After Use-season	19
7 Malfunction Codes of IDU	19
8 Troubleshooting	20

1 Safety Notices (Please be sure to abide them)

⚠ DANGER If not abide them strictly, it may cause severe damage to the unit or the people.

⚠ WARNING If not abide them strictly, it may cause slight or medium damage to the unit or the people.

⚠ CAUTION This sign indicates that the items must be prohibited. Improper operation may cause severe damage or death to people.

NOTICE This sign indicates that the items must be observed. Improper operation may cause damage to people or property.

⚠ WARNING
(1) This product can't be installed at corrosive, inflammable or explosive environment or the place with special requirements, such as kitchen. Otherwise, it will affect the normal operation or shorten the service life of the unit, or even cause fire hazard or serious injury. As for the above special places, please adopt special air conditioner with anti-corrosive or anti-explosion function.
(2) Follow this manual to complete the installation work. Please read this manual carefully before turning on or repairing the unit
(3) Diameter of power cord should be large enough. The damaged power cord and connection wire must be replaced with special cables.
(4) When the power cord is connected, please fix the electric box cover properly to avoid safety accidents.
(5) Never fail to comply with the nitrogen-charging welding process. Do charge nitrogen when welding the pipes.
(6) Never short circuit or cancel the pressure switch to prevent unit damage.
(7) As for the unit controlled by the wired controller, connect the wired controller well firstly and then energize the unit; otherwise, the unit can't operate normally.
(8) When installation is finished, please check whether the drainage pipes, pipelines and electric wires are connected correctly to avoid water leakage, refrigerant leakage, electric shock or fire, etc.
(9) Do not insert fingers or objects into air outlet or air return grille.
(10) Open the door and window frequently to keep good ventilation for avoiding oxygen deficit when gas heater or oil heater is used in the room.
(11) Never plug in or unplug the power plug directly to turn on or turn off the air conditioner.
(12) Once the air conditioner is turned on, it can be turned off only after it has operated for 5min at least; otherwise, it will affect the oil return of compressor.
(13) Do not allow children to operate this air conditioner.
(14) Do not operate this air conditioner with wet hands.
(15) The air conditioner can be cleaned only when it has been turned off and the power has been cut off; otherwise, it may cause electric shock or injury.
(16) Never spray or flush water towards the air conditioner; otherwise, malfunction or electric shock may happen.
(17) Do not expose the air conditioner to the moist or corrosive environment.
(18) Under cooling mode, please don't set the room temperature too low; keep the temperature difference between indoor and outdoor within 5°C (41°F).
(19) Do not repair the unit by yourself. Wrong maintenance may cause electric shock or fire hazard. Please contact Gree appointed service center for help.
(20) Before installation, please check whether the power supply is complied with that specified on the nameplate and check the safety of the power supply.
(21) Installation should be conducted by the dealer or qualified personnel. Please do not attempt to install the air conditioner by yourself. Improper installation may lead to water leakage, electric shock or fire hazard, etc.
(22) Be sure to use special accessories and parts for installation to prevent water leakage, electric shock and fire hazard, etc.
(23) The air conditioner must be grounded reliably for avoiding electric shock. Please do not connect the earthing wire to gas pipe, water pipe, lightning rod or telephone line.
(24) Put through the power 8 hours in advance before operation. Do not cut off the power when the air conditioner stops operation for only about one night (protect the compressor).
(25) If refrigerant leakage happens, please ventilate the room immediately.

⚠ WARNING

(26) Volatile liquid, such as diluent or gasoline, will damage the appearance of air conditioner. Only soft dry cloth and wet cloth dipped with neutral detergent can be used to clean the outer case of air conditioner.

(27) If there are any abnormal circumstances (such as burning smell, etc.), please turn off the unit and cut off the main power supply immediately, and then contact Gree appointed service center. If those abnormal circumstances still exist, the unit may be damaged and it may lead to electric shock or fire hazard.

(28) Under the standby status, the air conditioner will consume a little power for ensuring reliability of complete air conditioner, maintaining normal communication and preheating refrigerant. When the unit won't be used for a long time, cut off the power of the complete air conditioner. However, please preheat it when operating the unit next time.

Any personal injury or property loss caused by improper installation, improper debug, and unnecessary repair or not following the instructions of this manual should not be the responsibility of Gree Electric Appliances, Inc. of Zhuhai.

2 Product Introduction

2.1 Names of Key Components

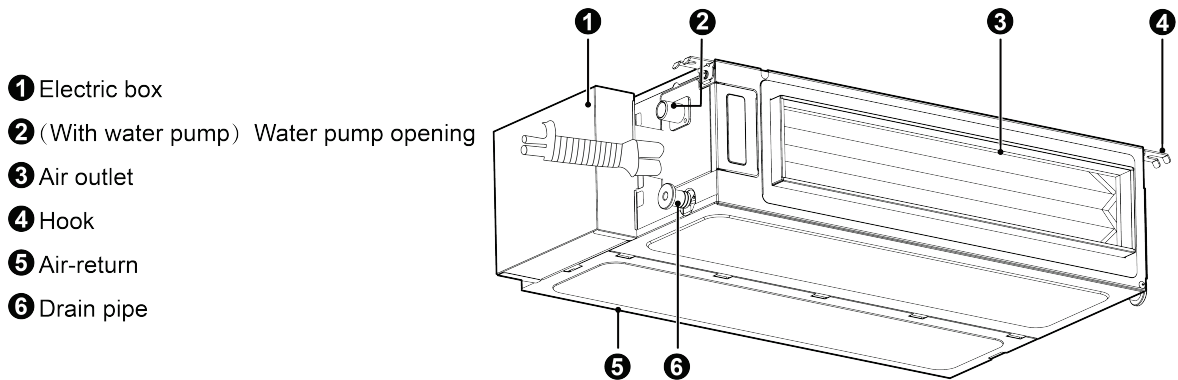

Fig 2.1.1

2.2 Rated Working Condition

—	Indoor Side Condition		Outdoor Side Condition	
	Dry Bulb Temp °C(°F)	Wet Bulb Temp °C(°F)	Dry Bulb Temp °C(°F)	Wet Bulb Temp °C(°F)
Rated Cooling	26.7(80.0)	19.4(67.0)	35(95.0)	23.9(75.0)
Rated Heating	21.1(70.0)	15.6(60.0)	8.3(47.0)	6.1(43.0)









3 Preparations for Installation

NOTICE

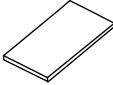
Product graphics are only for reference. Please refer to actual products. Unspecified measure unit is mm(in.).

3.1 Standard Fittings

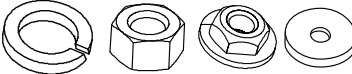
Please use the supplied standard fittings listed below as instructed.

No.	Name	Graphics	Quantity	Purpose
1	wire controller package (including wire controller, emergency bottom case, instruction manual, screws, packing box)		1set	Control indoor unit
2	Remote controller		0 or 1	optional parts (including #7 batteries)
3	Sponge for drainage pipe		2	wrap water pipe and rubber cork for condenser
4	Insulating materials		2	used for the joint of gas pipe and liquid pipe for indoor unit
5	Corrugated pipe		0 or 1	Diameter of air pipe $\geq 15.9\text{mm}$ (5/8 in.)
6	Union nut		1 or 2	one for the model with corrugated pipe; two for other models
7	Spring washer M8, nut M8, nut with washer M8, washer M8		4	Used for hanging the indoor unit
8	Tieline		6	Wrap the sponge at the connection position
9	Drain Hose Assembly		1	To connect with the hard PVC drain pipe
10	others	User Manual: 1 copy		

3.2 Location for Installation

- (1) The top holder must be strong enough to support unit's weight.
- (2) Drain pipe can drain water out easily.
- (3) There is no obstacle at inlet or outlet. Please ensure good air circulation.
- (4) In order to make sure the space for maintenance, please install the indoor unit according to the dimension described below.
- (5) Keep the unit away from heating source, inflammable gas or smoke.
- (6) This is a concealed ceiling type unit.
- (7) Indoor unit, outdoor unit, power cord and electric wire should stay at least 1m (39-3/8 in.) from the TV set and radio. Otherwise, these electrical appliances may have image interference and noise (Even if the distance is 1m (39-3/8 in.), when there is strong electric wave, noise may still occur).

(8) The appliance shall not be installed in the laundry.



Fig 3.2.1

NOTICE
(1) Installation of the unit must be in accordance with National Electric Codes and local regulations.
(2) Improper installation will affect unit's performance, so do not install the unit by yourself. Please contact local dealer to arrange professional technicians for the installation.
(3) Do not connect power until all installation work is finished.

3.3 Requirements for Communication Line

NOTICE
If the unit is installed in the place with strong electromagnetic interference, shielded wire must be applied on the communication wire between indoor unit and wired controller. Twisted pair line with shielding function must be applied on the communication wire between indoor unit and indoor unit (outdoor unit).

3.3.1 Select Communication Line for Indoor Unit and Wired Controller

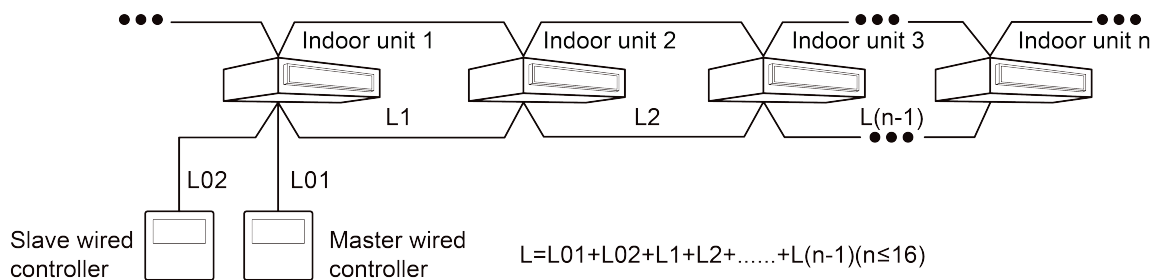

Fig 3.3.1.1

Material type	Total length of communication line between indoor unit and wired controller L (m/feet)	Wire size	Remarks
Light/Ordinary polyvinyl chloride sheathed cord	$L \leq 250\text{m}$ ($L \leq 820\text{-}1/5\text{ft.}$)	2×AWG18 ~2×AWG16	(1) Total length of communication line can't exceed 250m (820-1/5ft.). (2) The cord shall be Circular cord (the cores shall be twisted together). (3) If unit is installed in places with intense magnetic field or strong interference, it is necessary to use shielded wire.

3.3.2 Select Communication Line for Indoor Unit and Outdoor Unit

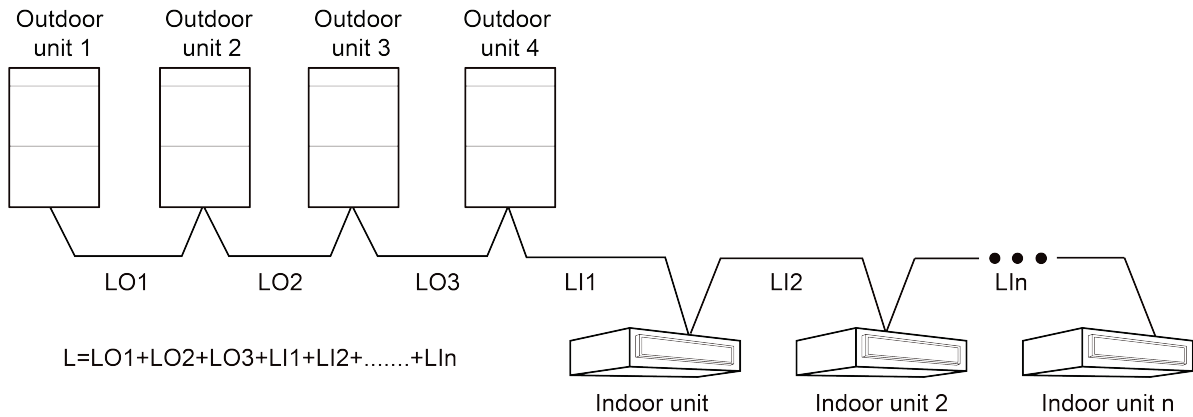

Fig 3.3.2.1

Material Type	Total Length L (m/feet) of Communication Cable between Indoor Unit and Indoor (Outdoor) Unit	Wire size	Remarks
Light/Ordinary polyvinyl chloride sheathed cord	$L \leq 1000m$ ($L \leq 3280-5/6ft.$)	$\geq 2 \times AWG18$	(1) If the wire diameter is enlarged to $2 \times AWG16$, the total communication line length can reach 1500 m (4921-1/4ft.). (2) The cord shall be Circular cord (the cores shall be twisted together). (3) If unit is installed in places with intense magnetic field or strong interference, it is necessary to use shielded wire.

3.4 Wiring Requirements

(1) Power Cord Size and Air Switch Capacity.

Model	Power Supply	Minimum Circuit Ampacity (A)	Maximum Overcurrent Protection (A)
GMV-ND05PLS/B1-T(U)	208/230V 1Ph 60Hz	1	15
GMV-ND07PLS/B1-T(U)		1	15
GMV-ND09PLS/B1-T(U)		1	15
GMV-ND12PLS/B1-T(U)		1	15
GMV-ND14PLS/B1-T(U)		1	15
GMV-ND18PLS/B1-T(U)		1	15
GMV-ND24PLS/B1-T(U)		1	15

NOTICE

- (1) Use copper wire only as unit's power cord. Operating temperature should be within its rated value.
- (2) If the power cord is more than 15m (49-1/4 ft.) long, please increase properly the sectional area of power cord to avoid accident due to overload.

(2) Install cut-off device near the unit. The minimum distance between each stage of cut-off device should be 3mm (1/8 in.) (The same for both indoor unit and outdoor unit).

(3) If the supply cord is damaged, it must be replaced by the manufacturer or its service agent or a similarly qualified person in order to avoid a hazard.

4 Installation Instructions

4.1 Installation of Indoor Unit

4.1.1 Outline Dimension and Installation Spots

Equip with a service port after lifting the unit. For the convenience of maintenance, the service port should be on one side of the electric box and below unit's lower level. Below are the outline dimension applicable to indoor units of GMV-ND05~24PLS/B1-T(U).

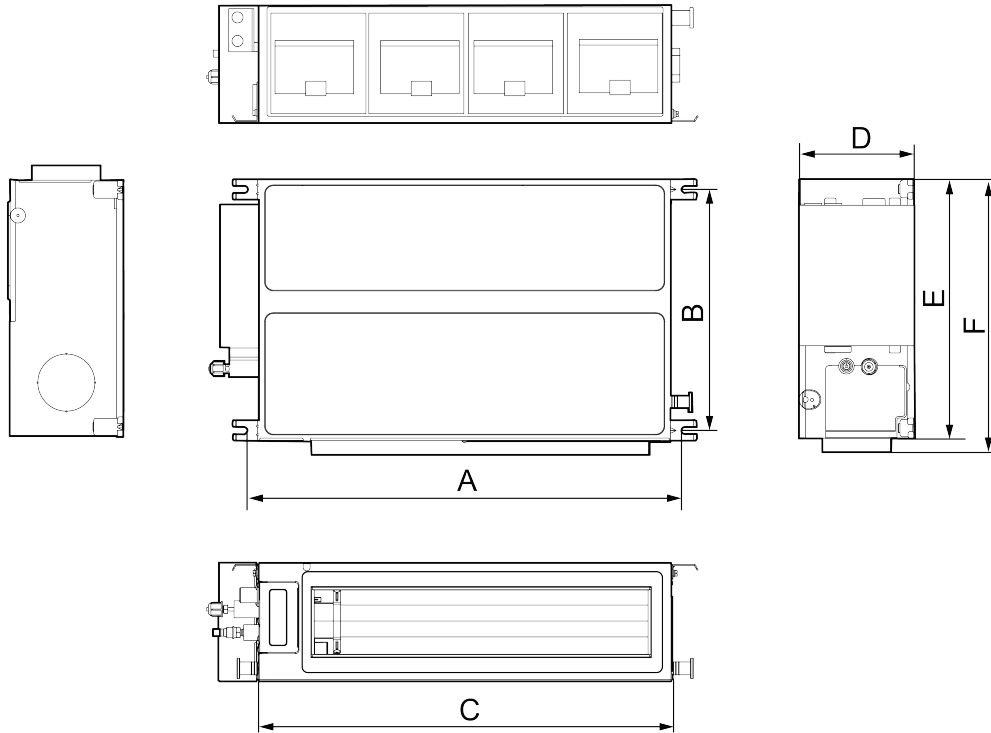

Fig 4.1.1.1

Below are dimensions of A, B, C, etc. for different models:

Unit: mm(in.)

Item Model	A	B	C	D	E	F
GMV-ND05~12PLS/B1-T(U)	760 (30)	415 (16-3/8)	710 (27-15/16)	200 (7-14/16)	462 (18-3/16)	486 (19-2/16)
GMV-ND14~18PLS/B1-T(U)	1060 (41-3/4)	415 (16-3/8)	1010 (39-12/16)	200 (7-14/16)	462 (18-3/16)	486 (19-2/16)
GMV-ND24PLS/B1-T(U)	1360 (53-1/2)	415 (16-3/8)	1310 (51-9/16)	200 (7-14/16)	462 (18-3/16)	486 (19-2/16)

NOTICE

One duct-type unit is only for one room.

4.1.2 Punching of Bolt Spots and Bolt Installation

Punch holes on the installation area according to the 4 spots on the paper pattern; The punching diameter may refer to the diameter of expansion bolt, about 60mm (2-3/8 in.) to 70mm (2-3/4 in.) depth, as shown in Fig 4.1.2.1.

Unit: mm(in.)

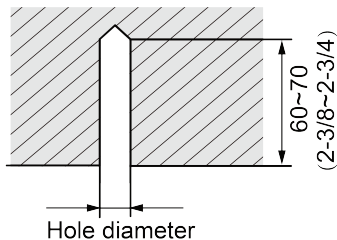

Fig 4.1.2.1

Insert the expansion bolt M10 into the hole and then drive the iron nail into the bolt, as shown in Fig 4.1.2.2.

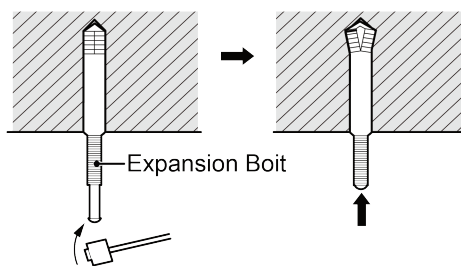

Fig 4.1.2.2

NOTICE

The length of bolt depends on the installation height of the unit, bolts are field supplied.

4.1.3 Lift the Unit

Lift up the unit to the ceiling and secure it on the bolt. Use specialized nut to secure the unit.

Unit: mm(in.)

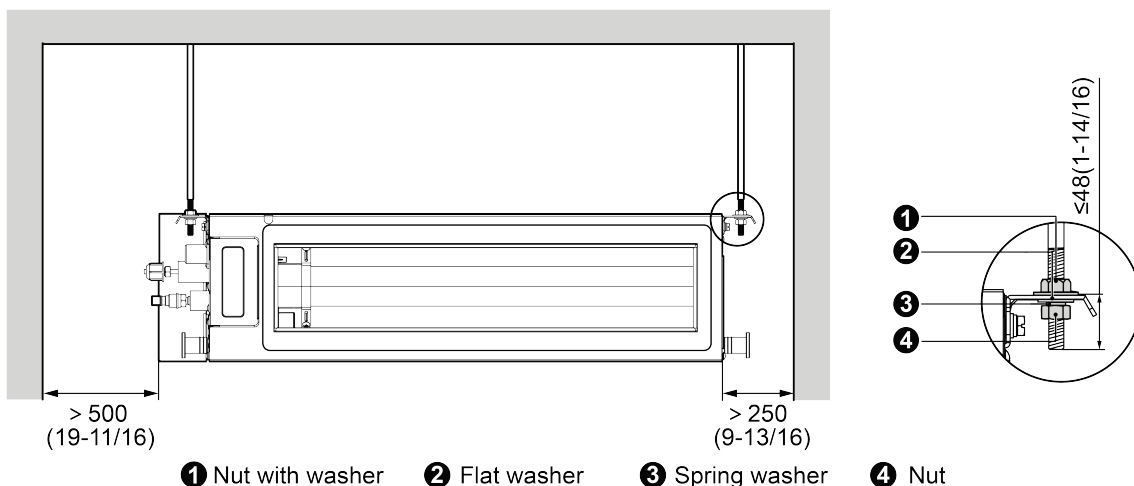

- ① Nut with washer
- ② Flat washer
- ③ Spring washer
- ④ Nut

Fig 4.1.3.1

NOTICE

- (1) Before installation, please finish the preparation work of all pipes (connection pipe, drain pipe) and wires (wired controller wire, connection wire of IDU and ODU) that need to be connected with the indoor unit.
- (2) Punch holes on the ceiling (air return opening or air inlet). Ceiling may have to be strengthened to make it level and to prevent it from vibration. You may consult user or constructor for details.
- (3) If the ceiling is not strong enough, you can install a beam bracket in a corner and secure the unit on the beam.

4.1.4 Horizontal Alignment

After the indoor unit is installed, remember to check the horizontal status of the whole unit. It should be horizontal from front to back and slant 1% from left to right, following the drainage direction, as shown in Fig 4.1.4.1.

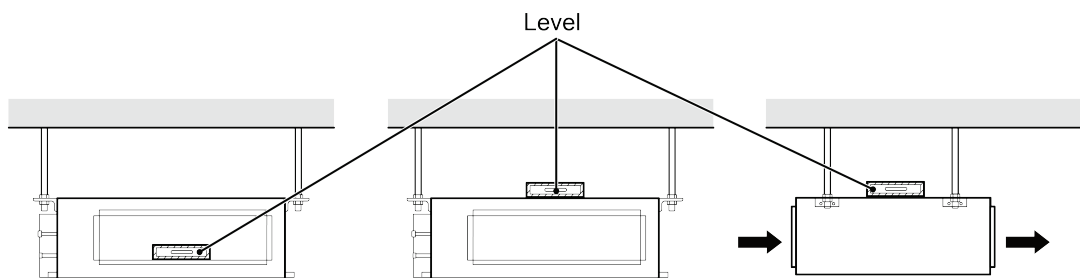

Fig 4.1.4.1

4.2 Pipe Connection

- (1) Direct the flaring of copper pipe to the center of screwed connection and then screw the flaring nut tight as shown in Fig 4.2.1.
- (2) Use a torque wrench to tighten up the flaring nut until the wrench gives out a click sound.

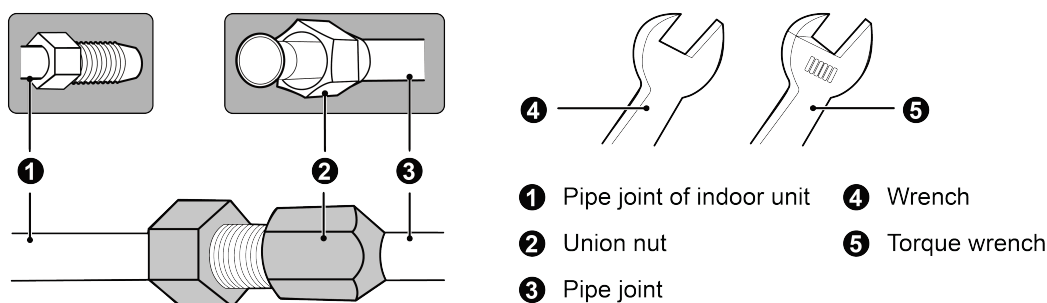

Fig 4.2.1

Torque for tightening nut	
Pipe diameter (mm/in.)	Torque (N · m)
Φ6.35(1/4)	15~30
Φ9.52(3/8)	35~40
Φ12.7(1/2)	45~50
Φ15.9(5/8)	60~65

- (3) The pipe should not be bent too much or it may crack. Use a pipe bender when bending the pipe.
- (4) Use a sponge to wrap the uninsulated connection pipe and the joint. Then tie it tight with a plastic tape.

4.3 Installation and Test of Drain Pipe

4.3.1 Notice for Installation of Drain Pipe

- (1) The drain pipe should be as short as possible and slope downward for at least 1%~2% so that condensate can drain out easily.
- (2) Size of the drainage hose must not be smaller than that of the drain pipe.
- (3) Install the drain pipe according to the following diagram and make it insulated. Improper installation will lead to water leakage and furniture and other objects may get wet.
- (4) You can buy local hard PVC pipe as drain pipe. When connecting the pipe, insert the end of PVC pipe into the drain hole and then tighten it up with a drain hose and cable tie. Do not use adhesives to connect drain hole and drain hose.
- (5) When the drain pipe is used for several equipment, the shared pipe should be about 100mm(3-7/8in.) lower than the drain hole of each equipment. In this case, use thicker pipe.
- (6) It is not allowed to connect the condensate drain pipe into waste pipe or other pipelines which are likely to produce corrosive or peculiar smell to prevent the smell from entering indoors or corrupt the unit.
- (7) It is not allowed to connect the condensate drain pipe into rain pipe to prevent rain water from pouring in and cause property loss or personal injury.
- (8) Condensate drain pipe should be connected into special drain system for air conditioner.

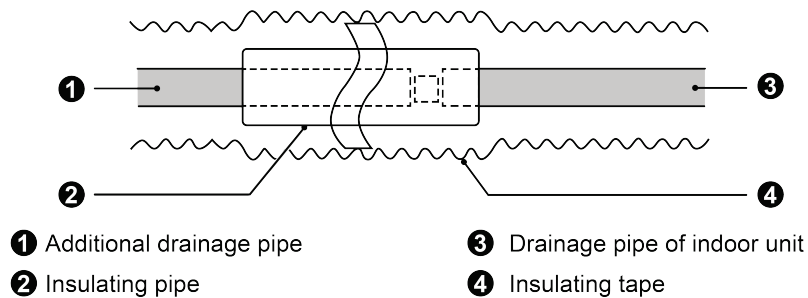

Fig 4.3.1.1

4.3.2 Installation of Drain Pipe

- (1) Insert the drain hose into the drain hole and tighten it with tapes, as shown in Fig 4.3.2.1.
- (2) Tighten the pipe clamp, with the distance between screw nut and hose smaller than 4mm (3/16 in.).

① metal clamp (accessory) ② drain hose (accessory) ③ Grey tape (accessory)

- (3) Use sealing plate to make the pipe clamp and hose insulated, as shown in Fig 4.3.2.2.

① metal clamp (accessory) ② thermal sponge (accessory)

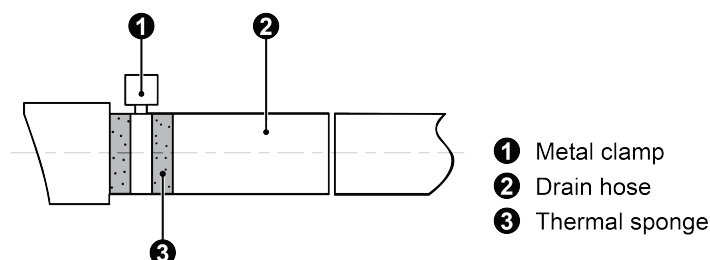

Fig 4.3.2.1

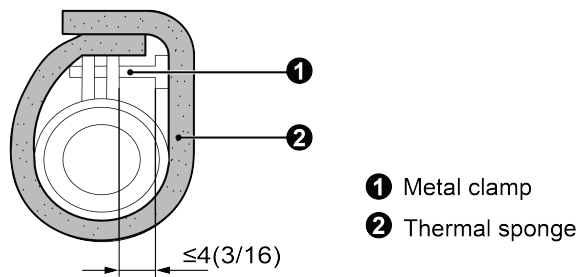

Fig 4.3.2.2

- (4) When connecting several drain pipes, follow the instruction as indicated in Fig 4.3.2.3. Choose the drain collecting pipe that matches with unit capacity.

Unit: mm(in.)

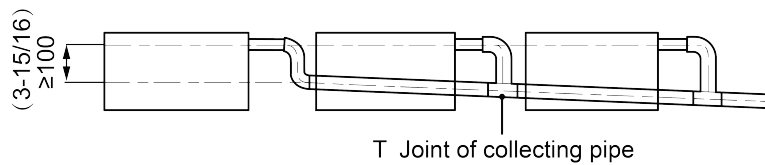

Fig 4.3.2.3

- (5) For indoor units that have high pressure at the outlet of drain pipe, use water-sealed joint.
 (6) For indoor units that have high pressure at the outlet of drain pipe, use water-sealed joint.
 (7) Install the water-sealed joint according to Fig 4.3.2.4.
 (8) Each unit should be installed with one water-sealed joint.

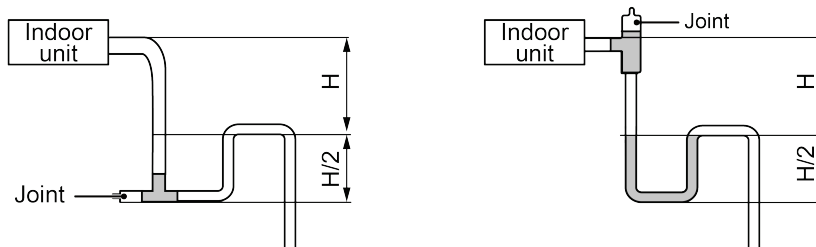

Fig 4.3.2.4

- (9) The horizontal pipe can be connected to vertical pipe in the same level; please select the connection way as shown in following fig.

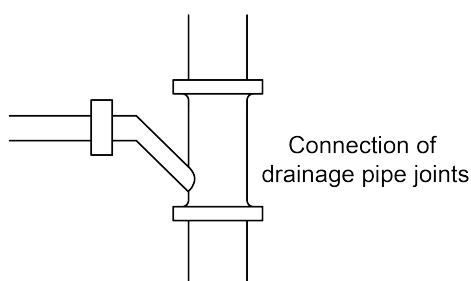

Fig 4.3.2.5

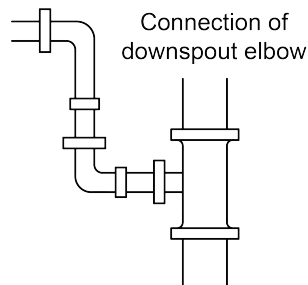

Fig 4.3.2.6

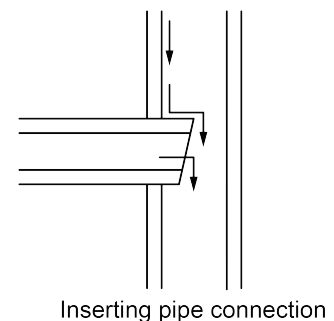

Fig 4.3.2.7

No.1: Connection of drainage pipe joints (Fig 4.3.2.5).

No.2: Connection of downspout elbow (Fig 4.3.2.6).

No.3: Inserting pipe connection (Fig 4.3.2.7).

- (10) The installation height of raising pipe for drainage should be lower than 850mm(33-1/2in.). The gradient from raising pipe towards drainage direction should be at least 1%~2%. If the raising pipe is vertical with the unit, the raising height should be less than 800mm(31-1/2 in.).

Unit: mm(in.)

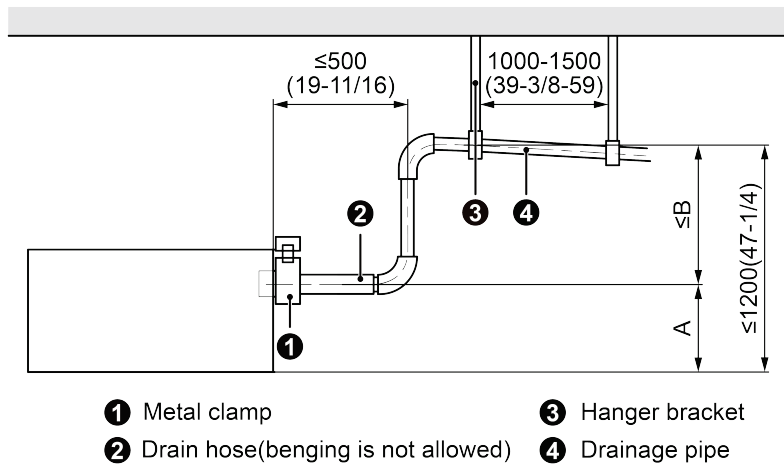

Fig 4.3.2.8

- (11) Drain pipes should have a downward slope of at least 1%~2%, in order to prevent pipes from sagging, install hanger bracket at intervals of 1000~1500mm(39-3/8~59 in.).

Unit: mm(in.)

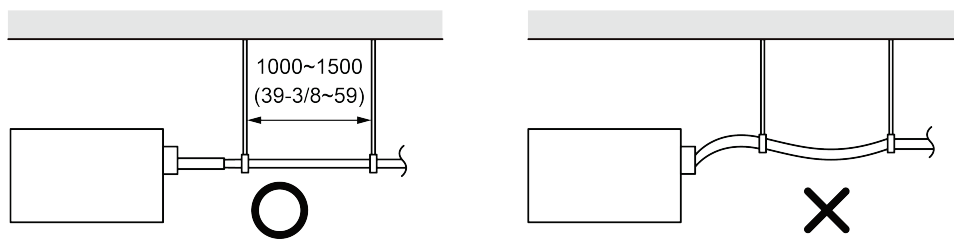

Fig 4.3.2.9

4.3.3 Test of Drainage System

■ Models without water pump

- (1) Fill some water to the water tray of indoor unit as following.
 - 1) Connect the drain hose to the other drain connection pipe of water tray and fill about 1L water (as shown in Fig 4.3.3.1) (Remove the drain hose after finishing testing and then put on the plug of water tray).
 - 2) Spray 1L water on evaporator with sprayer, as shown in Fig 4.3.3.2.

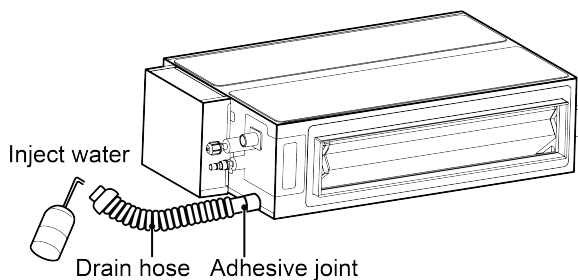

Fig 4.3.3.1

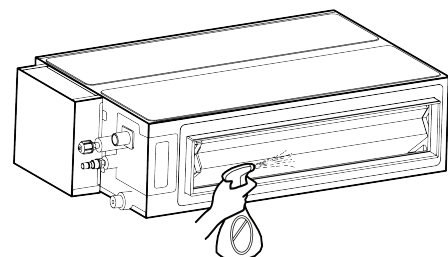

Fig 4.3.3.2

- (2) Check if the water drains smoothly from the drain pipe and check if there is water leakage on the connection pipe.

- (3) Arrange insulation of drain hose and pipe clamp after checking the drain system.
 - Models with water pump
- (1) Fill some water to the water tray of indoor unit as following.
 - 1) Connect the drain hose to the other drain connection pipe of water tray and fill about 1L water (as shown in Fig 4.3.3.1) (Remove the drain hose after finishing testing and then put on the plug of water tray).
 - 2) Spray 1L water on evaporator with sprayer, as shown in Fig 4.3.3.2.
- (2) Start the water to check if water drain smoothly. The starting method of water pump is as below.
 - 1) If project debugging of unit has been done, please set the indoor unit in cooling or dry mode. In this case, the water pump will operate automatically.
 - 2) If electrical wiring of unit hasn't been done, please open the electric box cover. Connect one phase power cord at L1, N or L, N of wiring board; About 60s after connecting power supply, indoor unit will report "C0" communication malfunction. In this case, the water pump will automatically operate for 10min and then stop; After checking the drain system, please cut off power supply, disconnect power cord and then put on the electric box cover.
- (3) Check if the water drains smoothly from the drain pipe and check if there is water leakage on the connection pipe.
- (4) Arrange insulation of drain hose and pipe clamp after checking the drain system.

4.4 Installation of Air Duct

NOTICE
(1) There should be insulation layer on air-out duct, air-return duct and fresh air duct to avoid heat loss and moisture. Adhere a nail on the air duct and then add thermal sponge with a layer of tin. Fasten it with a nail cover and then seal the junction with tin tapes; You can also use other materials that have good insulation quality.
(2) Each air-out duct and air-return duct should be fixed on a pre-made board with iron frame. The junction of air duct should be well-sealed in order to prevent air leakage.
(3) The design and construction of air duct should comply with national requirements.
(4) The edge of air-return duct is suggested to be more than 150mm (5-7/8 in.) away from the wall. Add a filter to the air-return opening.
(5) Please consider noise-damping and vibration damping for the design and construction of air duct. Besides, noise source must be away from people. For instance, do not have the air-return opening installed on top of the user(offices, rest area, etc.).

4.4.1 Installation of Air-out Duct

- (1) Installation of Rectangular Duct.

- ① Hanger rod
- ② Return air duct
- ③ Canvas duct
- ④ Return air inlet
- ⑤ Static pressure box
- ⑥ Filter screen
- ⑦ Main supply air duct
- ⑧ Supply air outlet

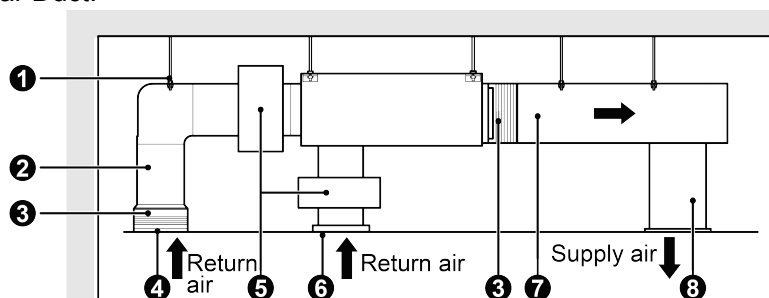

Fig 4.4.1.1

(2) Installation of Circular Duct.

- ① Return air duct
- ② Canvas duct
- ③ Return air blinds
- ④ Hanger rod
- ⑤ Supply air outlet
- ⑥ Transition pipe
- ⑦ Supply air duct
- ⑧ Diffuser
- ⑨ Diffuser connector

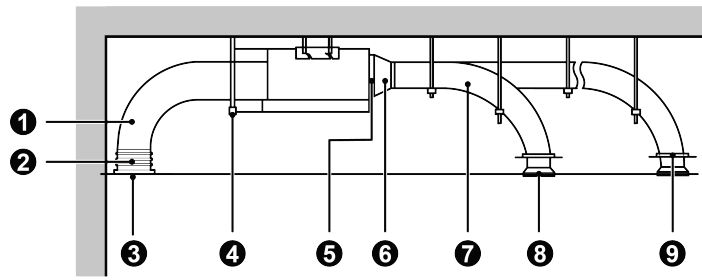

Fig 4.4.1.2

4.4.2 Shape and Size of Air Outlet and Air-return Opening

The following figure is applicable for the models below: GMV-ND05~24PLS/B1-T(U).

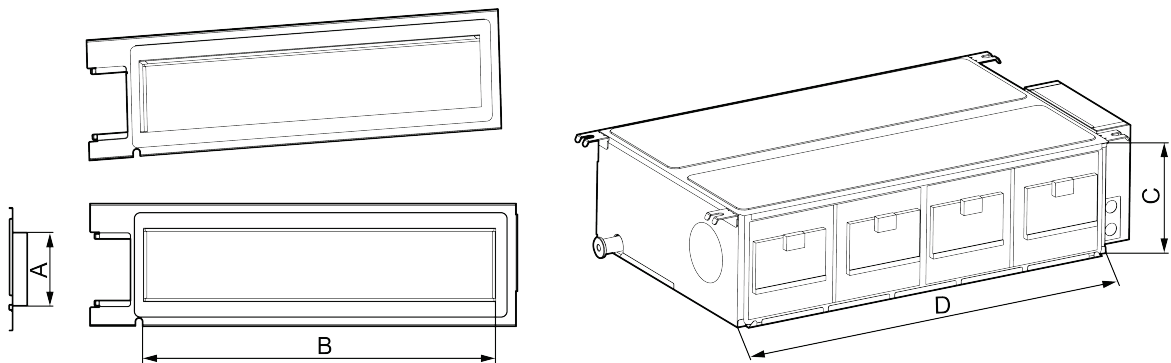

Fig 4.4.2.1

Model	Item	Dimension of air outlet flange		Dimension of air return	
		A (mm/in.)	B (mm/in.)	C (mm/in.)	D (mm/in.)
GMV-ND05~12PLS/B1-T(U)		122(4-3/4)	585(23-1/16)	200(7-14/16)	710(27-15/16)
GMV-ND14~18PLS/B1-T(U)		122(4-3/4)	885(23-1/16)	200(7-14/16)	710(27-15/16)
GMV-ND24PLS/B1-T(U)		122(4-3/4)	1185(23-1/16)	200(7-14/16)	710(27-15/16)

4.4.3 Installation of Air-return Duct

(1) Square flange is defaulted to be fitted on the back before ex-factory. Air-return cover is on the bottom, as shown in Fig 4.4.3.1.

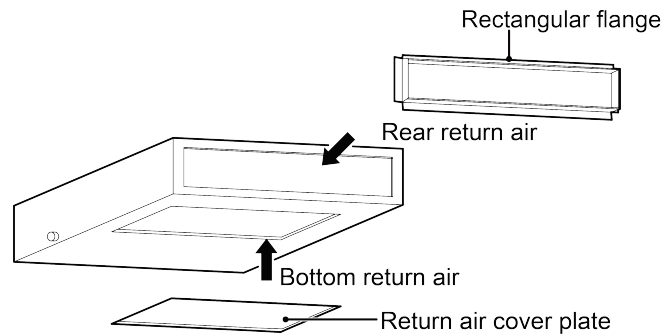

Fig 4.4.3.1

- (2) If air return from the bottom is needed, switch the positions of square flange and air-return cover.
- (3) Use a clincher to connect air-return duct to the air-return opening of indoor unit. The other end of air-return duct connects with the air-return louver. In order to adjust the height

conveniently, you can make a folded canvas duct and have it strengthened by 8# iron wire.

- (4) Air return from the bottom will produce more noise than air return from the back. So we suggest you to add a noise damper and static pressure case to lower noise if you choose air return from the bottom.
- (5) Select the appropriate installation way based on actual construction and maintenance needs, as shown in Fig 4.4.3.2.

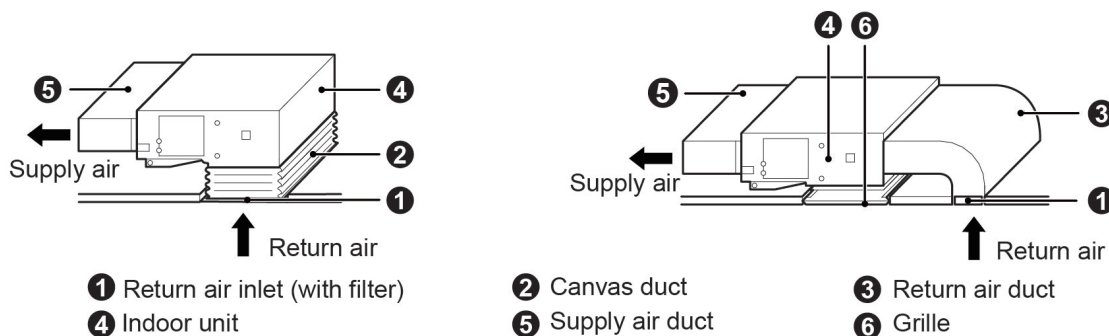

Fig 4.4.3.2

4.4.4 Installation of Fresh Air Duct

- (1) If a fresh air duct is needed, remove the fresh air baffle as shown in Fig 4.4.4.1. If a fresh air duct is not needed, block the gap on the baffle with sponge.
- (2) Install circular flange so that fresh air duct can be easily connected, as shown in Fig 4.4.4.2.
- (3) Both air duct and circular flange need to be well-sealed and insulated.
- (4) Fresh air should be the air that has been filtered.

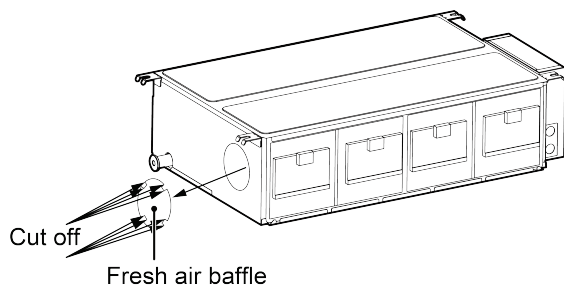

Fig 4.4.4.1

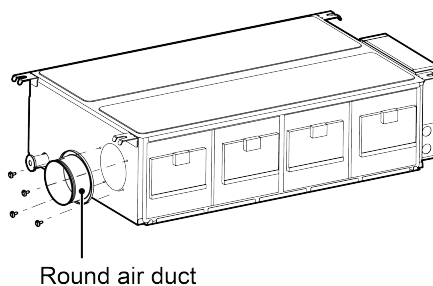

Fig 4.4.4.2

4.5 Installation of Wired Controller

Please refer to User Manual of Wired Controller for the installation details.

NOTICE

When installation is finished, the unit must be tested and debugged before operation. Please refer to Instruction Manual of ODU for auto addressing and debugging details.

5 Wire Connection

Before obtaining access to terminals, all supply circuits must be disconnected.

⚠ WARNING

- (1) For personal safety, the air conditioner must be properly grounded.
- (2) Read carefully the voltage indicated on the nameplate before connecting wires. Then connect wires according to the wiring diagram. Improper wiring will lead to abnormal operation or damage the unit.

⚠ WARNING

- | |
|--|
| (3) Power capacity should be large enough. Sectional area of room wires should be above 2.5mm ² (AWG13). |
| (4) For unit's power supply, please use specialized branch circuit and specialized power socket. |
| (5) All wiring must comply with standards to ensure safe and correct operation. |
| (6) Install specialized branch circuit breaker according to related laws and regulations and electrical standards. |
| (7) All wiring must use pressure terminal or single wire. Multi-twisted wire that connects directly to the wiring board may cause fire hazard. |
| (8) Keep the wires away from refrigerant pipe, compressor and fan. |
| (9) Do not alter the inner wires of air conditioner. Manufacturer does not assume responsibility for damage or abnormal operation due to this reason. |
| (10) If the unit is installed in places with strong electromagnetic interference, it's recommended to use twin-twisted shield wire. During wire connection, please pay attention that the metal shield layer of the twin-twisted wire must be grounded(outer case) in order to prevent the unit from electromagnetic interference. |
| (11) Communication line should be separated from the power cord and the connecting wire of IDU and ODU. |
| (12) If the project needs higher static pressure, you can set it through the wired controller. |

5.1 Connection of Wire and Wiring Board Terminal

(1) Connection of Single Branch Line (shown in Fig 5.1.1).

- 1) Use a wired stripper to strip away about 25mm (1 in.) of the insulation layer at the end of single branch line so that the single-core wire can be exposed.
- 2) Use a screwdriver to remove the terminal screw on the terminal board.
- 3) Use a plier to bend the end of single branch line until it forms a circle that has a similar size with the screw.
- 4) Lead the screw across the circle of the single branch line and fix it on the wiring board.

(2) Connection of Multi-twisted Wire (shown in Fig 5.1.2).

- 1) Use a wired stripper to strip away about 10mm (3/8 in.) of the insulation layer at the end of multi-twisted wire.
- 2) Use a screwdriver to remove screw on the wiring board of air conditioner.
- 3) Use a round terminal fastener or a plier to securely fasten the round terminal with each core wire of the multi-core wire.
- 4) Confirm each position of core wire on the round terminal and then use a screwdriver to tighten the terminal screw.

Unit: mm(in.)

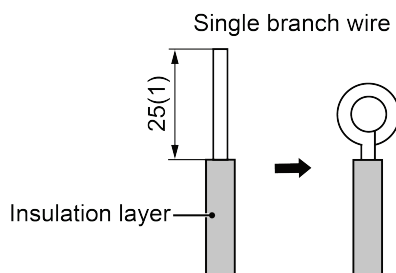

Fig 5.1.1

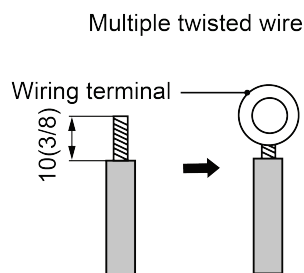
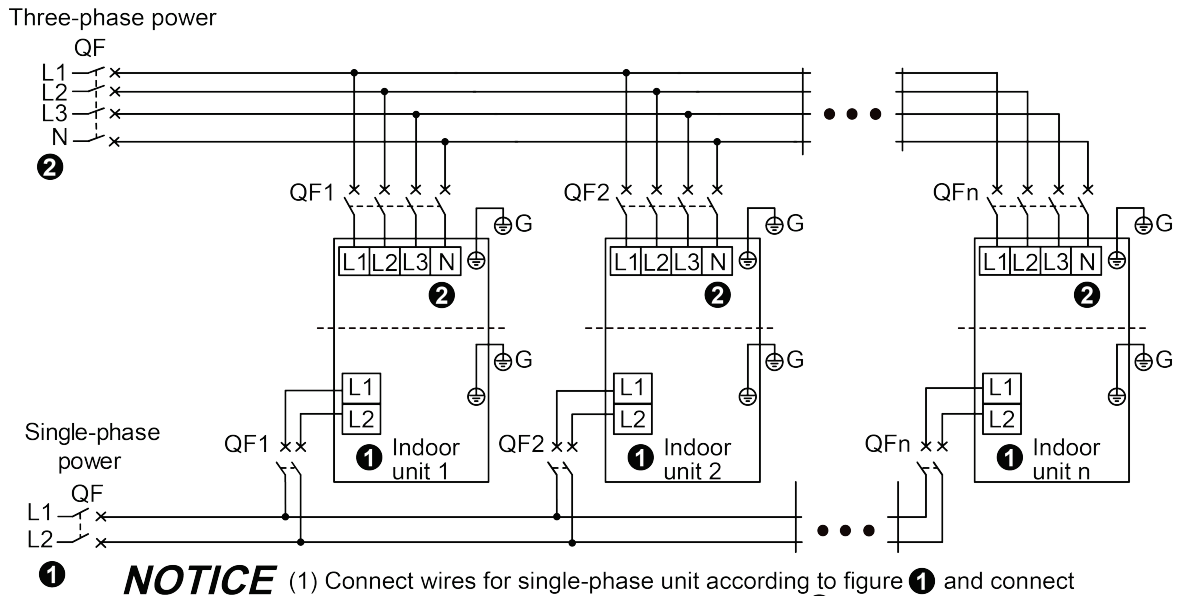

Fig 5.1.2

5.2 Power Cord Connection



- ① NOTICE** (1) Connect wires for single-phase unit according to figure ① and connect wires for three-phase unit according to figure ②. As for some areas where there's no neutral wire, please refer to the wiring diagram of unit for details.
- (2) The maximum connection quantity "n" for indoor unit is decided by the capacity of outdoor unit. Please refer to the unit capacity of unit for details.

Fig 5.2.1

Remark: The maximum number of indoor units that can be connected depends on the capacity of outdoor unit. For specific details, please refer to the capacity configuration part.

- (1) For air conditioner that uses single-phase power.
 - 1) Remove the cover of electric box of indoor unit.
 - 2) Lead the power cord across the rubber ring.
 - 3) Connect the power cord to the L1, L2 terminals and the grounding screw.
 - 4) Fasten the power cord with a wire clamp.

5.3 Connection of Communication Line of IDU and ODU

- (1) Open the cover of electric box of indoor unit.
- (2) Lead the communication line across the rubber ring.
- (3) Connect the communication line to terminal D1 and D2 on the 4-digit wiring board of indoor unit, as shown in Fig 5.3.1.

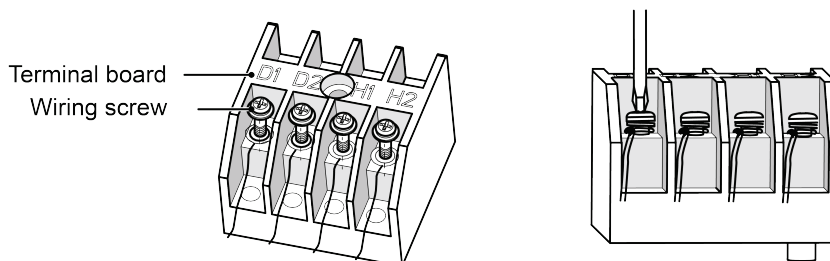
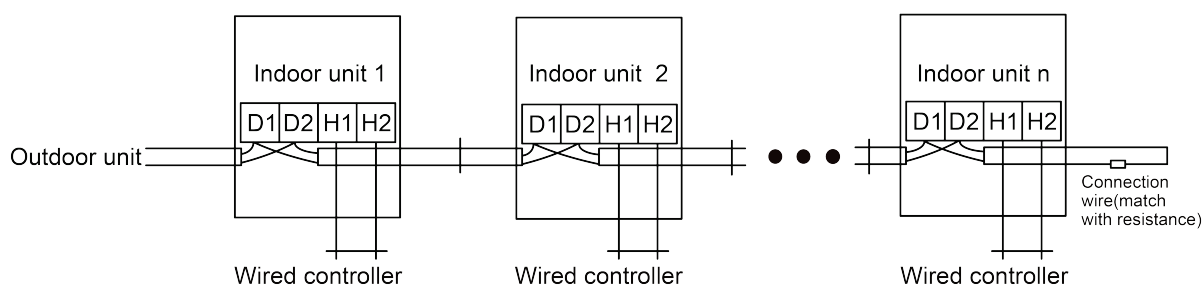

Fig 5.3.1



NOTICE Indoor unit quantity n is according to the outdoor unit capacity.

Fig 5.3.2

- (4) Secure the communication line with the wire clamp on the electric box.
- (5) In order to ensure the reliability of communication between IDU and ODU and the communication among each IDU, add a matched resistance (supplied in a package before ex-factory) on the wiring board of the last indoor unit in a series connection. The matched resistance should be connected in parallel between terminal screw D1 and D2, as shown in Fig 5.3.2.

5.4 Connection of Communication Line of Wired Controller

- (1) Open the cover of electric box of indoor unit.
- (2) Lead the communication line of wired controller across the rubber ring.
- (3) Connect the communication line of wired controller to terminal H1 and H2 on the 4-digit wiring board of indoor unit.
- (4) Use a wire clamp to fasten the communication line of wired controller.
- (5) Instruction of connection of wired controller.
- (6) Fig 5.4.1 shows the installation of wired controller.

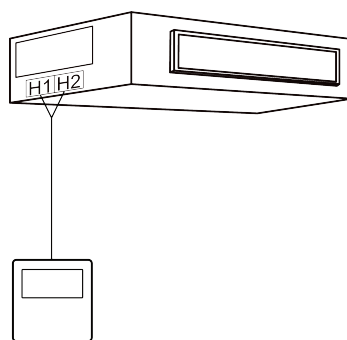

Fig 5.4.1

5.5 Instructions on Connecting Wired Controller and IDU Network

- (1) Communication between IDU and ODU is D1 while communication among each IDU is D2.
- (2) Communication between IDU and wired controller is H1, H2.
- (3) One indoor unit can connect two wired controllers (master wired controller and sub-master wired controller).
- (4) One wired controller is able to control 16 indoor units at the same time (shown in Fig 5.5.1).

NOTICE

- (1) When the wired controller is controlling multiple indoor units at the same time, the indoor units must be of the same model.
- (2) When two wired controllers are controlling the indoor units, you need to set an address for each wired controller. Address No.1 refers to master wired controller while address No.2 refers to sub-master wired controller. They should not share the same address. For specific setting methods, please refer to installation manual of wired controller.

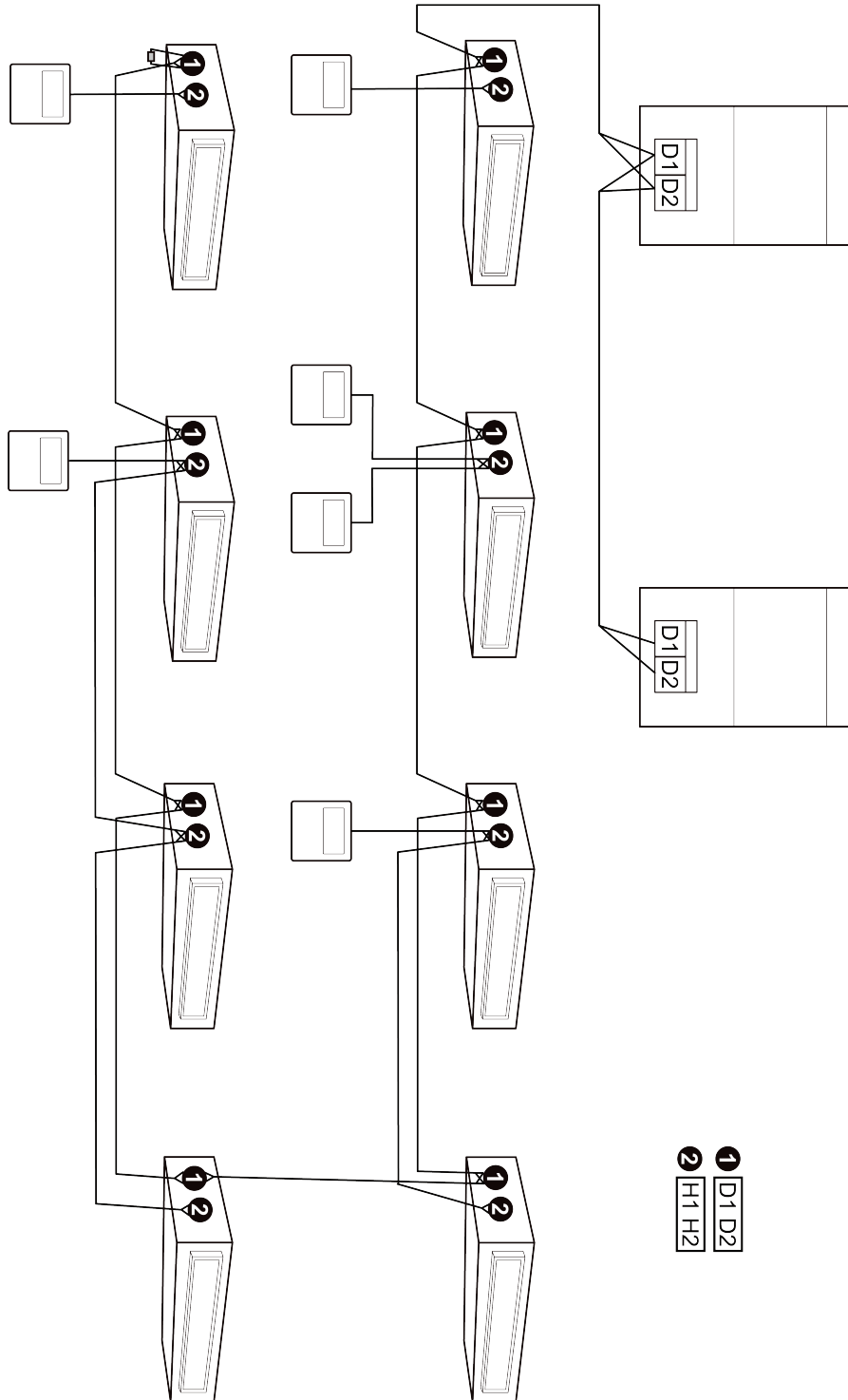

Fig 5.5.1

6 General Maintenance

WARNING

(1) Before the cleaning, turn unit off and disconnect power supply. Otherwise, it may result in electric shock or personal injury.
(2) When cleaning the air conditioner, please use stable standing platform.
(3) Do not clean the unit using hot water of over 45°C (113°F) to prevent the unit from losing color or deforming.
(4) Do not dry the unit on fire resources, otherwise the filter may get on fire or unshaped.
(5) Volatile liquid like thinner or gasoline will damage the air conditioner (Use soft dry cloth and wet cloth dipped with mild detergent to clean the filter of air conditioner).
(6) If any problem, please contact after-sales service agent for assistance.

6.1 Cleaning of Air Filter

- (1) Remove the air filter on the air inlet for cleaning. Use a dust catcher or water to clean it. If the filter is very dirty (e.g. greasy), you can clean it using warm water (below 45°C(113°F)) that is mixed with mild detergent. Then let it dry naturally under cool places.
- (2) If the air conditioner is used in dusty place, clean the air filter often (generally once every 2 weeks).

6.2 Maintenance Before Use-season

- (1) Check whether air inlets and air outlets of indoor units and outdoor units are blocked.
- (2) Check whether grounding wire is in good condition.
- (3) Check whether wire connection is correct.
- (4) Connect the power and check whether the display screen of wired controller shows any characters.

6.3 Maintenance After Use-season

- (1) When the weather is sunny, operate the air conditioner for half a day to let its inner part dry.
- (2) If you won't use the air conditioner for a long time, disconnect power please. When power is disconnected, characters on the display screen will disappear.

7 Malfunction Codes of IDU

Error Code	Content	Error Code	Content	Error Code	Content
L0	Indoor Unit Error	L9	Quantity Of Group Control Indoor Units Setting Error	d7	Humidity Sensor Error
L1	Indoor Fan Protection	LA	Indoor Units Incompatibility Error	d8	Water Temperature Sensor Error
L2	E-heater Protection	LH	Low Air Quality Warning	d9	Jumper Cap Error
L3	Water Full Protection	LC	Outdoor-Indoor Incompatibility Error	dA	Indoor Unit Hardware Address Error
L4	Wired Controller Power Supply Error	d1	Indoor Unit Circuit Board Error	dH	Wired Controller Circuit Board Error
L5	Anti-freezing Protection	d3	Ambient Temperature Sensor Error	dC	Capacity DIP Switch Setting Error
L7	No Master Indoor Unit Error	d4	Inlet Pipe Temperature Sensor Error	dL	Outlet Air Temperature Sensor Error

Multi Variable Air Conditioners Duct Type Indoor Unit

Error Code	Content	Error Code	Content	Error Code	Content
L8	Power Insufficiency Protection	d6	Outlet Pipe Temperature Sensor Error	dE	Indoor Unit CO ₂ Sensor Error
o1	Over low voltage of IDU bus	o2	Over high voltage of IDU bus	o3	IDU IPM module protection
o4	IDU startup failure	o5	IDU overcurrent protection	o6	IDU current detecting circuit error
o7	IDU non-synchronism protection	o8	IDU drive communication error	o9	Communication error of IDU master controller
oA	Over high temperature of IDU module	ob	Temperature sensor error of IDU module	oC	IDU charging circuit error
o0	Other drive error	db	Special Code: Field Debugging Code	—	—

8 Troubleshooting

If your air conditioner is not working well, please check the following table first before asking for service:

Phenomenon	Troubleshooting
The unit can't start.	Power supply is not connected. Circuit breaker tripping caused by leakage of electricity. Input voltage is too low. Defect of main PC-board.
The unit stops after running for a while.	The inlet or outlet of ODU or IDU is blocked by obstacle.
Poor cooling effect.	The filter is dirty. Too heavy heat load of room (e.g. too many people). Door or windows is open. Inlet and outlet of IDU are blocked. Setting temperature is too high. Refrigerant is insufficient (e.g. refrigerant leakage).
Poor heating effect.	The filter is dirty. Door or window is open. Setting temperature is too low. Refrigerant is insufficient (e.g. refrigerant leakage).
Indoor fan doesn't start up during heating.	At starting, the IDU fan could not operate till the heat exchange become hot, for preventing delivering the cool air. At defrosting, the IDU fan stopped due to system switch to cooling mode for preventing delivering the cool air, and resume operating after defrosting.

NOTICE

If air conditioner still fails to work normally after checking and handling as described above, please stop using it immediately and contact local service center for assistance.

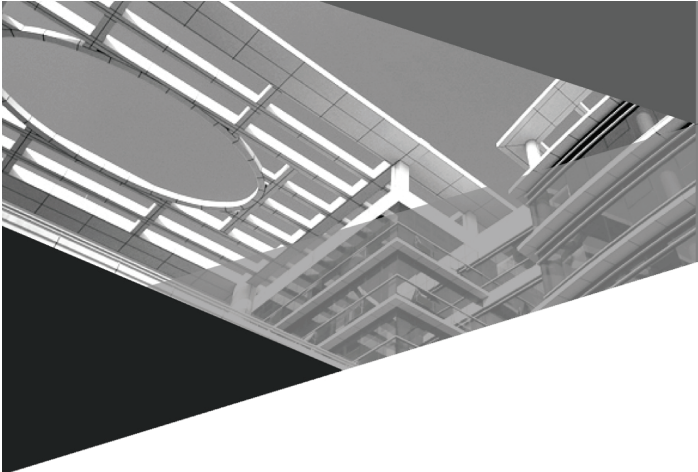

GREE ELECTRIC APPLIANCES, INC. OF ZHUHAI

Add: West Jinji Rd, Qianshan, Zhuhai, Guangdong, China, 519070

Tel: (+86-756) 8522218

Fax: (+86-756) 8669426

E-mail: global@cn.gree.com www.gree.com



600005063011